

NOTICE TO BIDDERS

NOTICE IS HEREBY GIVEN, that the Undersigned, on behalf of the Essex County Board of Supervisors, will accept sealed bids at the Office of the Purchasing Agent until 2:00 P.M. on January 23, 2019 for exterior Stair Replacement at the Government Center.

The bids shall be opened publicly and read aloud on January 23, 2019 at 2:00 P.M. at the Office of the Purchasing Agent, 7551 Court Street, Elizabethtown, New York 12932.

Please contact the Purchasing Office at (518) 873-3330 for additional information concerning the bidding. Specifications and standard proposals for the proposed work may be obtained at the above address, or on the County's website at: <https://www.co.essex.ny.us/bidders/publicbids.aspx>.

All bids submitted in response to this notice shall be marked "SEALED BID – STAIR REPLACEMENT" clearly on the outside of the envelope with the bidder's name and address.

Essex County affirmatively states that in regard to any contract entered into pursuant to these instructions, without regard to race, color, sex, religion, age, national origin, disability, sexual preference or Vietnam Era veteran status, disadvantaged and minority or women-owned business enterprises will be afforded equal opportunity to submit bids in response hereto.

Dated: December 17, 2018

Linda M. Wolf, CPA
Purchasing Agent
Essex County Government Center
7551 Court Street – PO Box 217
Elizabethtown, New York 12932
(518) 873-3332

INSTRUCTIONS TO BIDDERS

A pre-bid conference shall be held on Friday, January 9, 2019 at 9:00 AM in the Board of Supervisors Conference Room, 7551 Court Street, Elizabethtown, NY 12932. **All contractors who plan to submit a bid are urged to attend.**

Each proposal must be accompanied by either a Certified Check payable to Essex County Treasurer in the amount of five percent (5%) of amount of the bid or a Bid Bond, in a form acceptable to the Essex County Attorney.

Attention of the bidders is particularly called to the requirements as to the conditions of employment to be observed and minimum wage rates under the Contract.

All bids shall be submitted on the bid sheets included in the package, and no other forms shall be accepted.

Essex County reserves the right to reject any and all bids not considered to be in the best interest of Essex County, and to waive any technical or formal defect in the bids which is considered by Essex County to be merely irregular, immaterial, or unsubstantial.

In addition to bid sheets, the bidder shall submit executed non-collusion bid certificates signed by the bidder or one of its officers as required by the General Municipal Law Sec. 103d. The bidder shall also submit an executed certificate of compliance with the Iran Divestment Act signed by the bidder or one of its officers as required by the General Municipal Law Sec. 103g.

A Contract awarded pursuant to this notice shall be subject to the provisions of Sections 103-1, 103-b, 103-d and 103-g of the General Municipal Law.

The contract shall be completed within 120 days after contract award.

Please address all questions, in writing, to: lwolf@co.essex.ny.us.

Addenda will be posted on the Essex County Website, interested vendors are urged to check before submitting their bid.

Each bidder will need to complete, sign, have notarized and return the following documents with their Bid:

- 1) Vendor Responsibility Questionnaire
- 2) Certification of Compliance With Iran Divestment Act
- 3) Non-Collusive Bidding Certification

PROJECT SCHEDULE

CONTRACT DESCRIPTION: Exterior Stair Replacement

NOTICE TO BIDDERS: December 17, 2018

PRE-BID MEETING AT GOVERNMENT CENTER: January 9, 2019 at 9:00 am

BID OPENING DATE: January 23, 2019 at 2:00 pm

ESTIMATED START DATE: Immediately after Award

SUBSTANTIAL COMPLETION: Within 120 days of Contract Award

SPECIFICATIONS for

Stair Replacement at Government Center

SCOPE: It is the intent of these specifications to describe the Stair Replacement project above the Treasurer's Office in the Town of Elizabethtown, County of Essex, State of New York.

All material, equipment and labor furnished under this contract shall conform to the following Technical Specification sheets; unless the same are modified by the Essex County Superintendent of Public Works or his authorized representative.

The acceptance of the said labor and materials by the Essex County Superintendent of Public Works or by his authorized representative does not prevent subsequent rejection should the materials and/or workmanship be determined to be defective or not in compliance with the specifications.

COMPLETION DATE: The project should be completed with 120 days of contract award.

GENERAL: The Bidder shall provide all labor and materials necessary to complete the project as detailed in the project plans titled: ESSEX COUNTY GOVERNMENT CENTER REPLACEMENT STAIR PROJECT.

<u>Drawing #</u>	<u>Title</u>
T100	Title Sheet
A101	Plans and Sections
A102	Sections and Details

The Bidder agrees to furnish the materials as specified on the above listed project drawings and plans without exception.

ESSEX COUNTY GOVERNMENT CENTER REPLACEMENT STAIR PROJECT

7551 COURT STREET, ELIZABETHTOWN, NY 12932

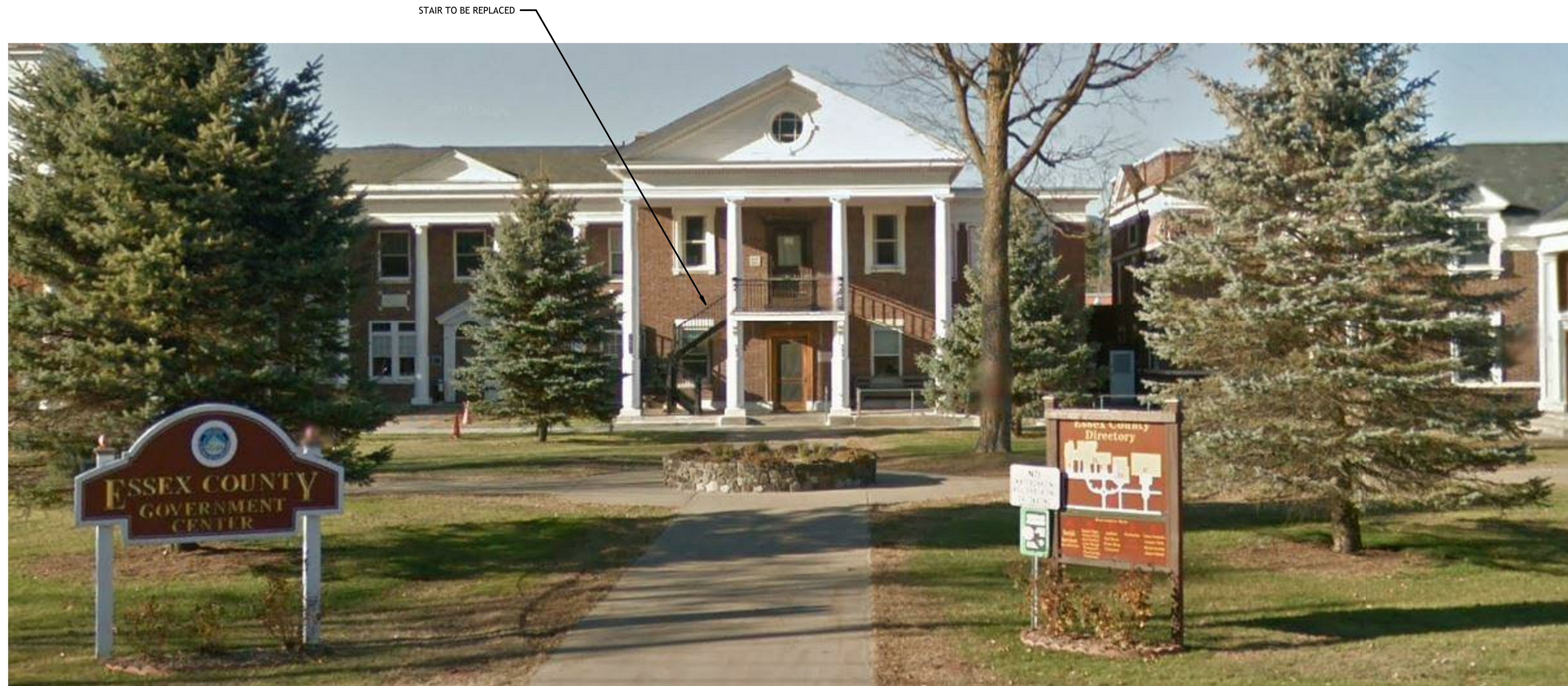

GENERAL NOTES

1. CONTRACTOR SHALL VERIFY ALL EXISTING CONDITIONS AND DIMENSIONS AND REPORT DISCREPANCIES TO OWNER/ENGR BEFORE PROCEEDING WITH THE WORK.
2. ALL WORK DETAILED &/OR SPECIFICALLY DENOTED WITHIN SHALL BE BY GENERAL CONTRACTOR UNLESS OTHERWISE INDICATED. REFERENCE ALL DRAWINGS FOR ADDITIONAL SCOPE OF WORK REQUIREMENTS.
3. WHILE EVERY ATTEMPT HAS BEEN MADE IN THE PREPARATION OF THIS PLAN TO AVOID MISTAKES, THE MAKER CANNOT GUARANTEE AGAINST HUMAN ERROR. THE CONTRACTOR ON THE JOB MUST CHECK ALL DIMENSIONS & DETAILS AND BE RESPONSIBLE FOR SAME.
4. CONFORM TO ALL DIMENSIONS INDICATED IN PREFERENCE TO SCALED DIMENSIONS FROM THE BLUEPRINT.
5. ALL WOOD EXPOSED TO WEATHER TO BE PRESSURE TREATED.

CODE REVIEW

STAIR & LANDING

- 1011.5.2 RISER HEIGHT AND TREAD DEPTH. STAIR RISER HEIGHTS SHALL BE 7 INCHES (178 MM) MAXIMUM AND 4 INCHES (102 MM) MINIMUM. RECTANGULAR TREAD DEPTHS SHALL BE 11 INCHES (279 MM) MINIMUM.
- 1011.5.4 DIMENSIONAL UNIFORMITY. STAIR TREADS AND RISERS SHALL BE OF UNIFORM SIZE AND SHAPE. THE TOLERANCE BETWEEN THE LARGEST AND SMALLEST RISER HEIGHT OR BETWEEN THE LARGEST AND SMALLEST TREAD DEPTH SHALL NOT EXCEED 3/8 INCH (9.5 MM) IN ANY FLIGHT OF STAIRS.
- 1011.5.5 NOSING AND RISER PROFILE. NOSINGS SHALL HAVE A CURVATURE OR BEVEL OF NOT LESS THAN 1/16 INCH (1.6 MM) BUT NOT MORE THAN 9/16 INCH (14.3 MM) FROM THE FOREMOST PROJECTION OF THE TREAD. RISERS SHALL BE SOLID AND VERTICAL OR SLOPED UNDER THE TREAD ABOVE FROM THE UNDERSIDE OF THE NOSING ABOVE AT AN ANGLE NOT MORE THAN 30 DEGREES (0.52 RAD) FROM THE VERTICAL.
- 1011.6 STAIRWAY LANDINGS. THERE SHALL BE A FLOOR OR LANDING AT THE TOP AND BOTTOM OF EACH STAIRWAY. THE WIDTH OF LANDINGS SHALL BE NOT LESS THAN THE WIDTH OF STAIRWAYS SERVED.

RAILINGS

- 1014.2 HEIGHT. HANDRAIL HEIGHT, MEASURED ABOVE STAIR TREAD NOSINGS, OR FINISH SURFACE OF RAMP SLOPE, SHALL BE UNIFORM, NOT LESS THAN 34 INCHES (864 MM) AND NOT MORE THAN 38 INCHES (965 MM).
- 1014.3.1 TYPE I. HANDRAILS WITH A CIRCULAR CROSS SECTION SHALL HAVE AN OUTSIDE DIAMETER OF NOT LESS THAN 1 1/4 INCHES (32 MM) AND NOT GREATER THAN 2 INCHES (51 MM).
- 1015.2 WHERE REQUIRED. GUARDS SHALL BE LOCATED ALONG OPEN-SIDED WALKING SURFACES, INCLUDING MEZZANINES, EQUIPMENT PLATFORMS, AISLES, STAIRS, RAMPS AND LANDINGS THAT ARE LOCATED MORE THAN 30 INCHES (762 MM) MEASURED VERTICALLY TO THE FLOOR OR GRADE BELOW AT ANY POINT WITHIN 36 INCHES (914 MM) HORIZONTALLY TO THE EDGE OF THE OPEN SIDE.
- 1015.3 HEIGHT. REQUIRED GUARDS SHALL BE NOT LESS THAN 42 INCHES (1067 MM) HIGH, MEASURED VERTICALLY.
- 1015.4 OPENING LIMITATIONS. REQUIRED GUARDS SHALL NOT HAVE OPENINGS THAT ALLOW PASSAGE OF A SPHERE 4 INCHES (102 MM) IN DIAMETER FROM THE WALKING SURFACE TO THE REQUIRED GUARD.

1 EXTERIOR IMAGE

T100 N.T.S.

BID SET

SHEET LIST

SHEET NO.	SHEET NAME
T100	TITLE SHEET
A102	SECTIONS & DETAILS
A101	PLANS AND SECTIONS

LOCATION MAP

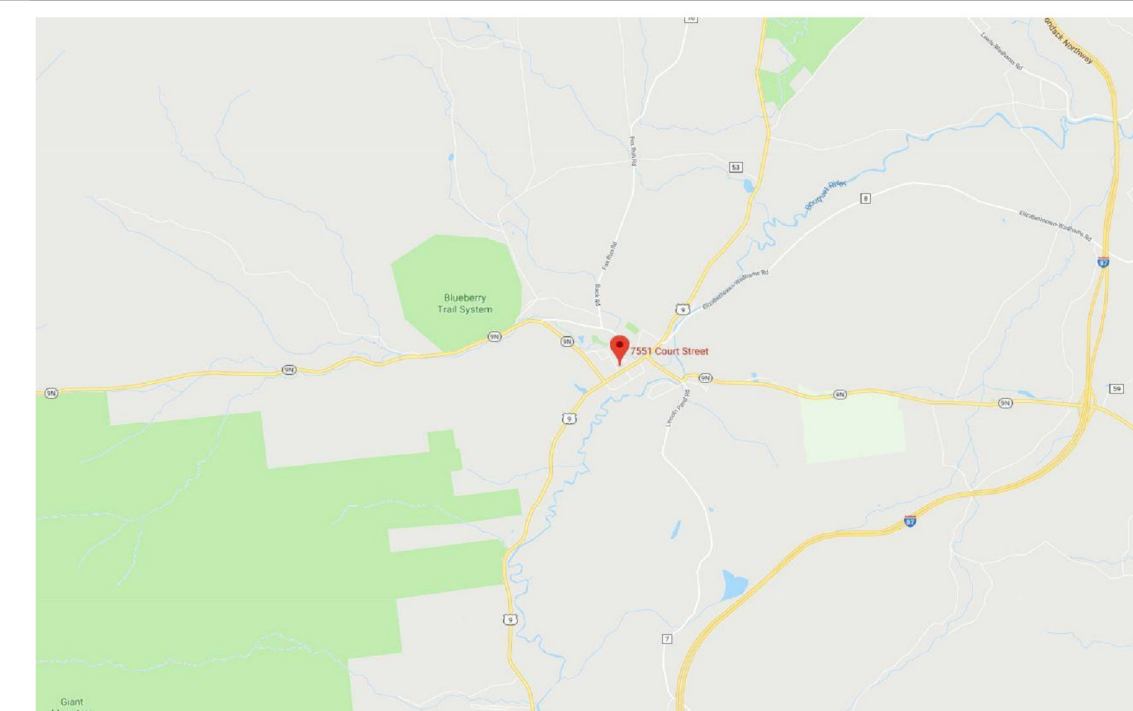

AERIAL VIEW



UNAUTHORIZED ALTERATIONS AND/OR ADDITIONS TO THIS DRAWING BEARING A LICENSED ARCHITECT'S OR ENGINEER'S SEAL IS A VIOLATION OF SECTION 7209, SUBDIVISION 2, OF THE NEW YORK STATE EDUCATION LAW. ONLY COPIES FROM THE ORIGINAL OF THIS DRAWING BEARING THE ORIGINAL ARCHITECT'S OR ENGINEER'S SEAL AND SIGNATURE SHALL BE CONSIDERED VALID TRUE COPIES.

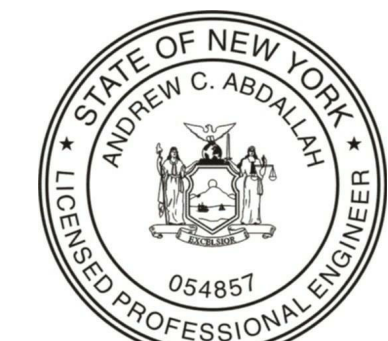

TITLE SHEET

PROJECT NO. 16071-003
DATE 12-06-18
DRAWN BY LKT
CHECKED BY SEC

T100

12/6/2018 11:13:58 AM

Established in 1985

AEDA

Architectural & Engineering DESIGN Associates, P.C.

1246 Rt. 3
P.O. Box 742
Plattsburgh, New York 12901
tel: 518.562.1800
fax: 518.562.1702
email: aedapc@aedapc.com

REVISIONS		
#	BY	DATE

PLANS AND SECTIONS

PROJECT NO. 16071-003
DATE 12-06-18
DRAWN BY LKT
CHECKED BY SEC

A101

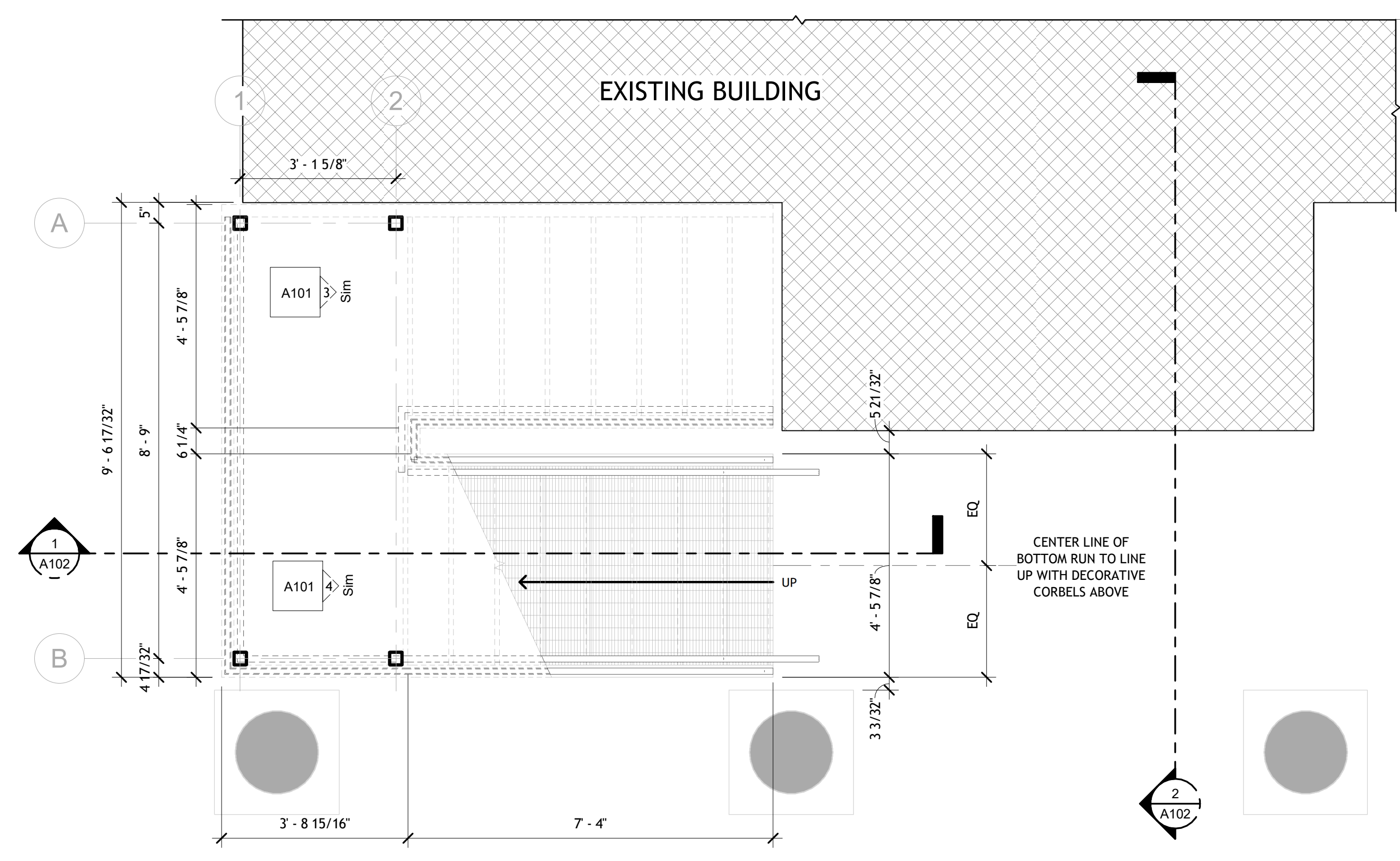

1 GROUND LEVEL
1/2" = 1'-0"



CUT & REMOVE COMPLETE EXISTING IRON STAIR ASSEMBLY

CUT & REMOVE EXISTING IRON RAILING ASSEMBLY ALONG LENGTH OF STAIR. SAVE PICKETS FOR REUSE

REMOVE EXISTING WOOD STAIRS, LANDING & RAILING ASSEMBLIES IN TOTAL

3 EXISTING CONDITIONS 1
1/4" = 1'-0"

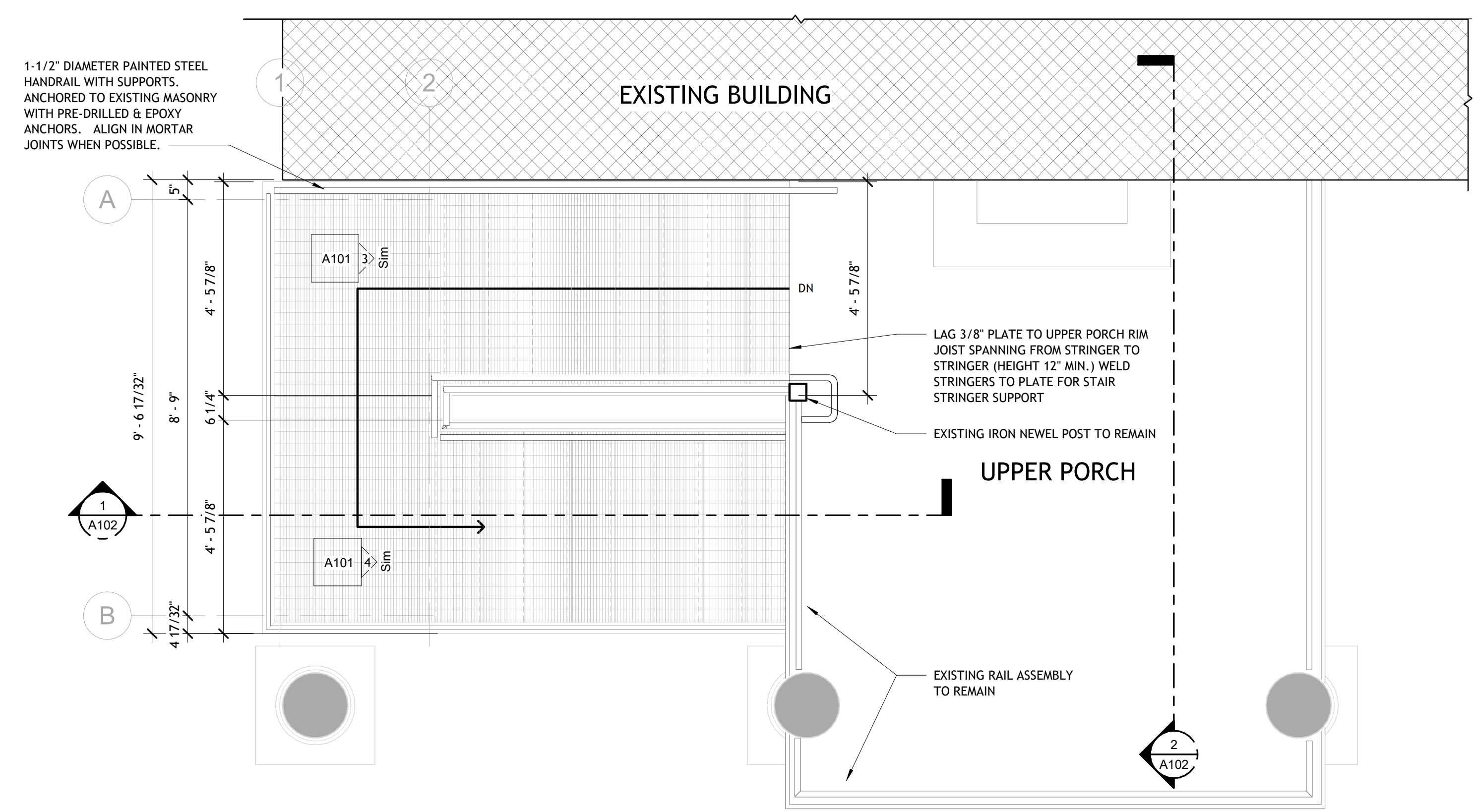

2 SECOND LEVEL
1/2" = 1'-0"



MODIFY TRIM FOR NEW STRINGERS

EXISTING NEWEL POST TO REMAIN. WELD NEW GUARDRAIL TO NEWEL POST. HANDRAIL TO EXTEND AROUND POST 16"

EXISTING IRON GUARDRAIL ASSEMBLY TO REMAIN AROUND UPPER PORCH

4 EXISTING CONDITIONS 2
1/4" = 1'-0"

BID SET

REVISIONS		
#	BY	DATE

SECTIONS & DETAILS

PROJECT NO. 16071-003
DATE 12-06-18
DRAWN BY JRH
CHECKED BY SEC

STEEL NOTES

- ALL STRUCTURAL STEEL WORK SHALL CONFORM TO THE "SPECIFICATIONS FOR STRUCTURAL STEEL BUILDINGS" OF THE AMERICAN INSTITUTE OF STEEL CONSTRUCTION (AISC) AND TO THE REQUIREMENTS OF LOCAL BUILDING CODES.
- STRUCTURAL STEEL SHALL BE AS FOLLOWS:
 - W SHAPES: ASTM A572, GRADE 50
 - OTHER SHAPES, BARS AND PLATES: ASTM A36
 - STRUCTURAL TUBING: ASTM A500, GRADE B
 - PIPING: ASTM A53, GRADE B OR ASTM A501
- SHOP PAINTING SHALL CONSIST OF SSPC-3 (POWER TOOL CLEANING) SURFACE PREPARATION AND MODIFIED ALKYL TYPE PRIMER APPLIED AT 2.0 TO 3.5 MILS DFT.
- SHOP CONNECTIONS MAY BE WELDED OR BOLTED. FIELD CONNECTIONS SHALL BE BOLTED UNLESS SPECIFICALLY SHOWN AS WELDED. BOLTS SHALL CONFORM TO ASTM A325. MINIMUM BOLT DIAMETER SHALL BE 3/4". ALL CONNECTIONS SHALL BE TYPE 2 ANGLE FRAMING CONNECTIONS UNLESS SHOWN OTHERWISE.
- STEEL CONNECTIONS SHALL BE STANDARD AISC FRAMED BEAM CONNECTIONS. FOR NON-COMPOSITE MEMBERS PROVIDE CONNECTIONS BASED REACTION AS DETERMINED FROM AISC UNIFORM LOAD TABLE UNLESS OTHERWISE NOTED ON PLANS. FOR COMPOSITE MEMBERS PROVIDE CONNECTIONS BASED ON 1.5 X REACTION FROM AISC UNIFORM LOAD TABLE UNLESS OTHERWISE NOTED ON PLANS. REINFORCING IS TO BE PROVIDED AT CONNECTIONS WHERE CUTS REDUCE THE SHEAR OR MOMENT CAPACITY BELOW TO SUSTAIN THE REACTION. FLANGES AND WEB ARE TO BE REINFORCED WHERE THE LOCAL CAPACITY TO SUSTAIN CONNECTION LOAD IS INADEQUATE. CONNECTIONS SHALL BE DESIGNED FOR SHEAR AND ECCENTRICITY, CONSIDERING THAT THE CONNECTION IS AN EXTENSION OF THE BEAM AND GIRDERS.
- WELDING SHALL BE PERFORMED BY CERTIFIED LICENSED WELDERS THAT ARE AWS QUALIFIED. WELDING ELECTRODES SHALL BE ASTM A233, CLASS E70XX (USE LOW HYDROGEN ELECTRODES FOR A572, GRADE 50 STEEL)
- ALL WELDING AND DETAILS SHALL BE AS RECOMMENDED BY THE AISC AND SHALL CONFORM TO THE REQUIREMENTS OF THE AMERICAN WELDING SOCIETY. MINIMUM SIZE FOR FILLET WELDS SPACED AT 12 INCHES MAXIMUM O.C. ALL EDGES OF DECK SHALL BE PROPERLY SUPPORTED.
- SET BEARING PLATES TO PROPER ELEVATION USING NON SHRINK, NON METALLIC GROUT.
- PROVIDE TEMPORARY BRACING AND SHORING AS REQUIRED; REMOVE WHEN FINAL CONNECTIONS PLACED.

SHOP DRAWINGS

SHOP DRAWINGS: SUBMIT ELECTRONIC COPY IN PORTABLE DATA FORMAT (PDF), SCANNED USING 300 DPI RESOLUTION. AN ELECTRONICALLY MARK-UP WILL BE RETURNED. CREATE PDF'S AT NATIVE SIZE AND RIGHT-SIDE UP. ILLEGIBLE FILES WILL BE REJECTED.

STAIR AND RAILING ASSEMBLIES ARE TO BE APPROVED THROUGH SUBMITTALS. STAIRS, HANDRAILS & GUARDRAILS SHALL BE SUBMITTED AS SHOP DRAWINGS AND APPROVED BY OWNER / ARCHITECT.

COMPLETE STAIR AND RAILING ASSEMBLIES TO BE PAINTED BLACK TO MATCH EXISTING.

RAILING NOTE

1015.4 OPENING LIMITATIONS. REQUIRED GUARDS SHALL NOT HAVE OPENINGS THAT ALLOW PASSAGE OF A SPHERE 4 INCHES (102 MM) IN DIAMETER FROM THE WALKING SURFACE TO THE REQUIRED GUARD.

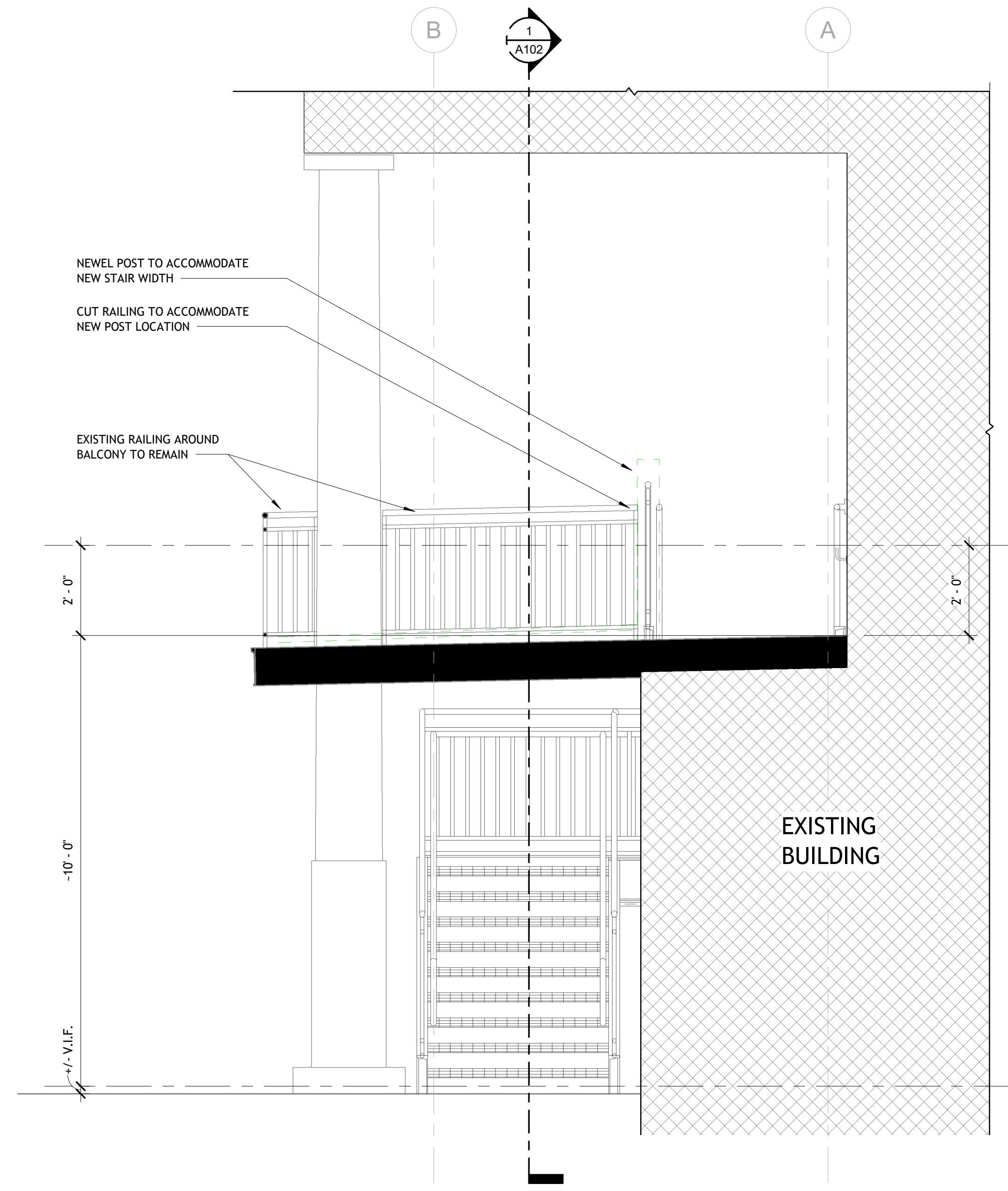

SECTION 1
1/2" = 1'-0"

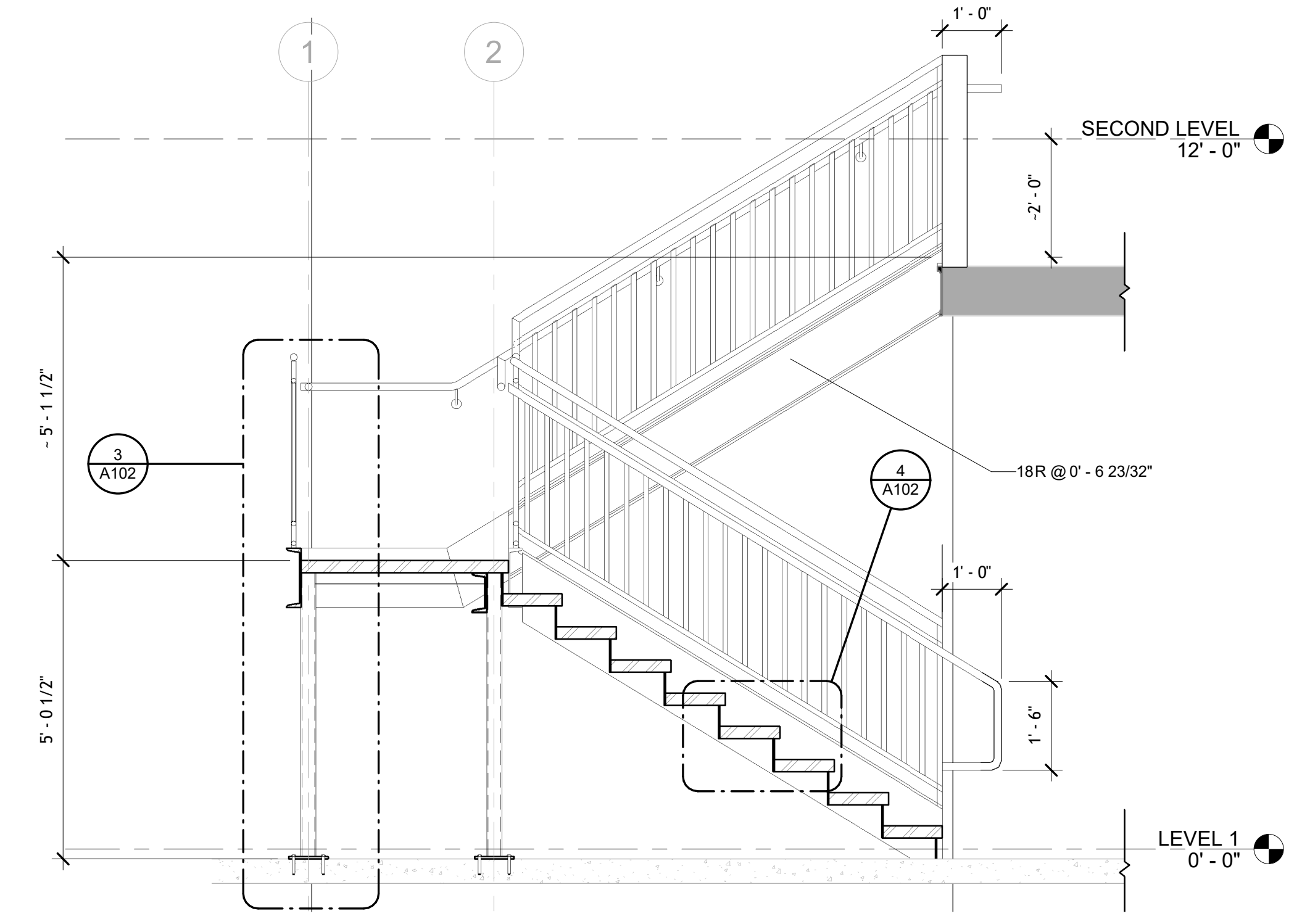

SECTION 3
1/2" = 1'-0"

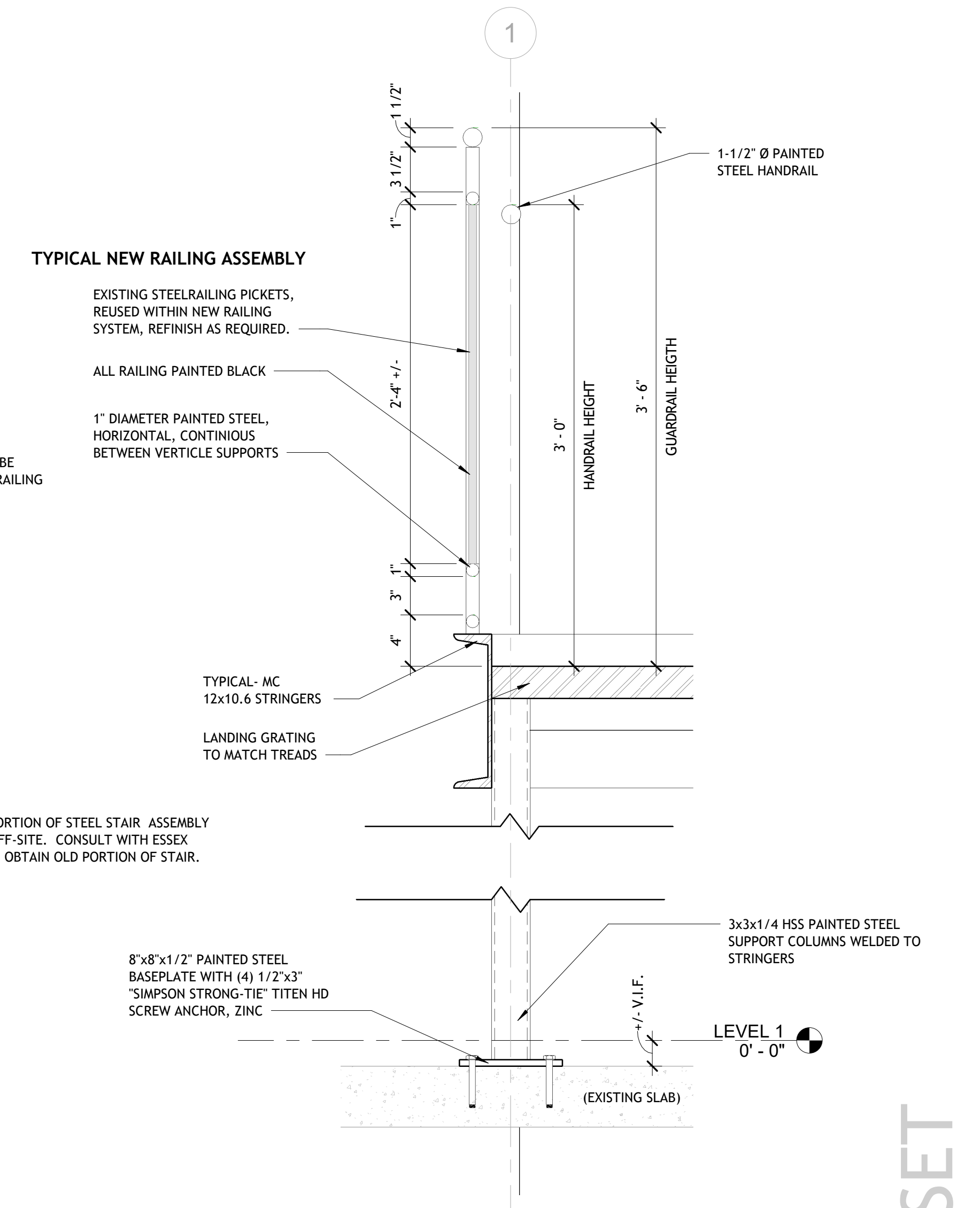

LANDING SUPPORT DETAIL
1 1/2" = 1'-0"

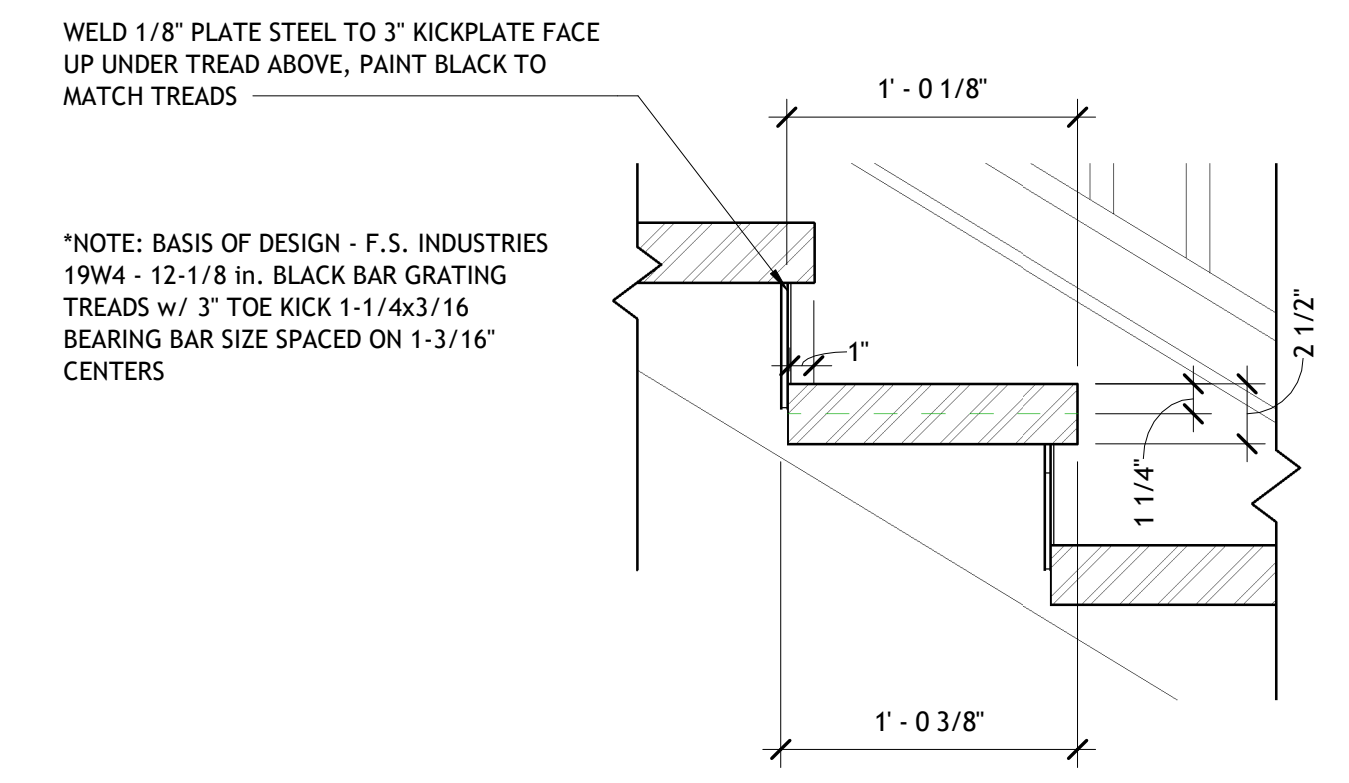

TREAD DETAIL
1 1/2" = 1'-0"

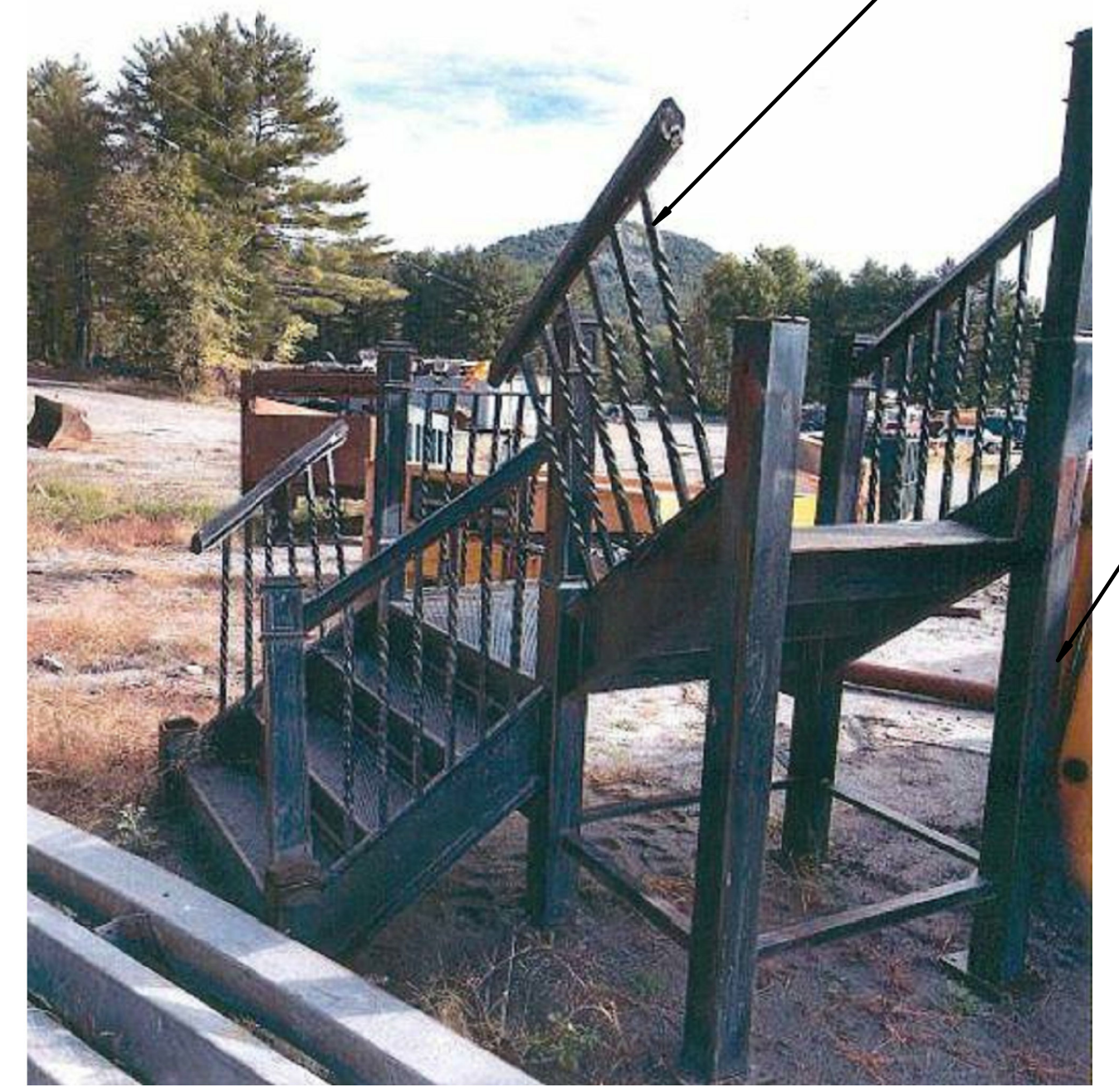

EXISTING RAILING
1/4" = 1'-0"

BID SET

EXHIBIT C

INSURANCE REQUIREMENTS – PUBLIC WORKS CONTRACTORS

I. The Contractor and each of its subcontractors shall procure and maintain during the entire term of the contract the following required insurance:

- **Commercial General Liability Insurance**
\$1,000,000 per occurrence / \$2,000,000 aggregate, including coverage for liability assumed by contract, completed operations, explosion, collapse, underground hazard and products liability.
- **Automobile Liability**
\$1,000,000 combined single limit for owned, hired and borrowed and non-owned motor vehicles.
- **Workers' Compensation**
Statutory Workers' Compensation and Employers' Liability Insurance for all employees.
- **Owners & Contractors Protective Liability Insurance**
\$2,000,000 per occurrence / \$2,000,000 aggregate.
- **Excess/Umbrella Liability Insurance**
\$1,000,000 per occurrence / \$2,000,000 aggregate.

II. Notwithstanding any terms, conditions or provisions, in any other writing between the parties, the Contractor hereby agrees to name the County as:

- (a) an additional insured on the Contractor's Commercial General Liability, Automobile Liability and Excess/Umbrella Liability insurance policies, and
- (b) a named insured on the Owners & Contractors Protective Liability Insurance Policy.

III. The policy/policies of insurance furnished by the Contractor shall:

- be from an A.M. Best rated "A" New York State licensed insurer; and
- contain a 30-day notice of cancellation

IV. The Contractor agrees to indemnify the County for any applicable deductibles.

V. Contractor acknowledges that failure to obtain such insurance on behalf of the County constitutes a material breach of contract and subjects it to liability for damages, indemnification and all other legal remedies available to the County. Prior to commencement of work or use of facilities, the Contractor shall provide to the County proof that such requirements have been met by furnishing certificate(s) of such insurance, and the declarations pages from the policies of such insurance. The failure of the County to object to the contents of the certificate(s) and/or declarations pages, or the absence of same, shall not be deemed a waiver of any and all rights held by the County.

VI. All certificates of insurance will provide 30 days notice to the county of cancellation or non-renewal.

VII. Contractor and subcontractor waives all rights of subrogation against the owner and will have the General Liability, Umbrella Liability Workers' Compensation policies endorsed setting forth this Waiver of Subrogation.

VIII. All policies will also contain no exclusions with respect to Section 240 and 241 of the NYS Labor Law.

IX. The County shall be listed as an additional insured on a primary and non-contributory basis.

X. All Contractors Subcontractors shall comply with these provisions and shall list the County as additional insured on a primary and non-contributory basis.

APPENDIX D - STANDARD CLAUSES FOR ESSEX COUNTY CONTRACTS

1. Independent Contractor Status

The parties each acknowledge, covenant and agree that the relationship of the Contractor to the County shall be that of an independent contractor. The Contractor, in accordance with its status as an independent contractor, further covenants and agrees that it:

- (a) will conduct itself in accordance with its status as an independent contractor;
- (b) will neither hold itself out as nor claim to be an officer or employee of the County; and
- (c) will not make any claim, demand or application for any right or privilege applicable to an officer or employee of the County, including but not limited to workers' compensation benefits, unemployment insurance benefits, social security coverage or retirement membership or credits.

2. Contractor To Comply With Laws/Regulations

The Contractor shall at all times comply with all applicable state and federal laws, rules and regulations governing the performance and rendition of the services to be furnished under this agreement.

3. Licenses, Permits, Etc.

The Contractor shall, during the term of this agreement, obtain and keep in full force and effect any and all licenses, permits and certificates required by any governmental authority having jurisdiction over the rendition and performance of the services to be furnished by the Contractor under this agreement.

4. Termination

This agreement may be terminated without cause by either party upon 30 days prior written notice, and upon such termination neither party shall have any claim or cause of action against the other except for services actually performed and mileage expenses actually incurred prior to such termination. Notwithstanding the foregoing, this agreement may be immediately terminated by the County:

- (a) for the Contractor's breach of this agreement, by serving written notice of such termination stating the nature of the breach upon the Contractor by personal delivery or by certified mail, return receipt requested, and upon such termination either party shall have such rights and remedies against the other as provided by law; or
- (b) upon the reduction or discontinuance of funding by the State or Federal governments to be used in furnishing some or all of the work, labor and/or services provided for under this agreement, and upon such termination neither party shall have any claim or cause of action against the other except for services actually performed and expenses (if the same are to be paid under this agreement) actually incurred prior to such termination.

5. Defense & Indemnification

The Contractor shall defend, indemnify and hold harmless the County to the fullest extent allowed by law, and notwithstanding any insurance requirements, from and against any and all liability, losses, claims, actions, demands, damages, expenses, suits, judgments, orders, causes of action and claims, including but not limited to attorney's fees, legal costs, and all other costs of defense, by reason of any liability whatsoever imposed by law or otherwise upon the County for damages to person, property or of any other kind in nature, including but not limited to those for bodily injury, property damage, death arising out of or in connection with its officers, employees, agents, contractors, sub-contractors, guests or invitees negligence or its/their performance or failure to perform this agreement. This language shall

be inserted by Contractor in all agreements between Contractor and its subcontractors and subcontractors will indemnify and hold harmless the County pursuant to its terms.

6. **Discrimination Prohibited**

The services to be furnished and rendered under this agreement by the Contractor shall be available to any and all residents of Essex County without regard to race, color, creed, sex, religion, national or ethnic origin, handicap, or source of payment; and under no circumstances shall a resident's financial ability to pay for the services provided be considered unless such consideration is allowed by State and/or Federal law, rule or regulation.

7. **Non-Discrimination In Employment**

The Contractor will not discriminate against any employee or applicant for employment because of race, creed, color, sex, national origin, age, disability or marital status. In the event that this is a contract to be performed in whole or in part within the State of New York for (a) the construction, alteration or repair of any public building or public work, (b) for the manufacture, sale or distribution of materials, equipment or supplies, (c) for building service, the Contractor agrees that neither it nor its subcontractors shall, by reason of race, creed, color, disability, sex or national origin:

- (1) discriminate in hiring against any citizen who is qualified and available to perform the work; or
- (2) discriminate against or intimidate any employee hired for the performance of work under this contract.

The Contractor agrees to be subject to fines of \$50.00 per person per day for any violation of this paragraph, as well as to possible termination of this contract or forfeiture of all moneys due hereunder for a second or subsequent violation.

8. **Damage/Injury To Persons & Property**

The Contractor shall promptly advise the County of all damages to property of the County or of others, or of injuries incurred by persons other than employees of the Contractor, in any manner relating, either directly or indirectly, to the performance of this agreement.

9. **Records**

The Contractor shall establish and maintain complete and accurate books, records, documents, accounts and other evidence directly pertinent to performance under this contract (hereinafter collectively "the Records") in accordance with the following requirements:

- (a) the Records must be kept for the balance of the calendar year in which they were made and for six (6) additional years thereafter;
- (b) the County Auditor, State Comptroller, the Attorney General or any other person or entity authorized to conduct an examination, as well as the agency or agencies involved in this contract, shall have access to the Records during normal business hours at an office of the Contractor within the State of New York, or, if no such office is available, at a mutually agreeable and reasonable venue within the State, for the term specified above for the purposes of inspection, auditing and copying.

The County shall take reasonable steps to protect from public disclosure any of the records which are exempt from disclosure under Section 87 of the Public Officers Law (the "Statute") provided that: (i) the Contractor shall timely inform an appropriate County official, in writing, that said records should not be disclosed; and (ii) said records shall be sufficiently identified and designation of said records as exempt under the statute is reasonable. Nothing

contained herein shall diminish, or in any way adversely affect, the County's right to discovery in any pending or future litigation.

10. **Claims For Payment**

All invoices or claims for which payment is sought from the County must be submitted in accordance with the following:

- (a) each claim for payment must include
 - (1) an invoice detailing the claim,
 - (2) copies of all documentation supporting the claim,
 - (3) a properly completed County standard voucher, which includes
 - (i) the County contract number under which payment is being claimed, **AND**
 - (ii) the payee's Federal employer identification number or Federal social security number, or both such numbers when the payee has both such numbers. *[Failure to include this number or numbers will prevent and preclude payment by the County; except that where the payee does not have such number or numbers, the payee, on the invoice or County voucher, must give the reason or reasons why the payee does not have such number or numbers and such reasons constitute a valid excuse under law.]*
- (b) Unless otherwise provided in this agreement, each claim for payment must be submitted to the County no later than 30 days after the work, labor, materials, and/or services for which payment is claimed were rendered or furnished.
- (c) Notwithstanding any other provision of this agreement, no claim for payment shall be valid, and the County shall not be liable for payment thereof, unless it is submitted to the County within 30 days of the close of the calendar year in which the work, labor, materials, and/or services for which payment is claimed were rendered or furnished.
- (d) Unless otherwise provided in this agreement, the requirements of this paragraph 10, and/or of any other provisions of this agreement which supersede the same, shall constitute conditions precedent to the County's payment obligation, and failure to comply with any or all of said requirements shall entitle the County to deny payment.
- (e) As a further condition of payment, each claim of payment shall be accompanied by a Contractor and Sub-Contractor Progress Payment Waiver, Release and Discharge, and each Final Payment shall be accompanied by a Contractor and Sub-Contractor Final Payment, Waiver and Release form. As well as a Contractor Affidavit relative to Final Payment. Copies of these forms are attached and made a part hereof. (Please disregard if these forms do not pertain).

11. **Consent**

In the event that State or Federal law requires the recipient of services to be furnished and rendered under this agreement to give his/her prior consent thereto, the contractor shall obtain such person's consent and furnish proof thereof to the County.

12. **Executory Clause**

The County shall have no liability under this contract to the Contractor or to anyone else beyond the funds appropriated and available for this contract.

13. **Public Work & Building Service Contract Requirements**

If this is a public work contract covered by Article 8 of the Labor Law or a building service contract covered by Article 9 thereof:

- (a) neither the Contractor's employees nor the employees of its subcontractors may be required or permitted to work more than the number of hours or days stated in said

- statutes, except as otherwise provided in the Labor Law and as set forth in prevailing wage and supplement schedules issued by the State Labor Department; and
- (b) the Contractor and its subcontractors must pay at least the prevailing wage rate and pay or provide the prevailing supplements, including the premium rates for overtime pay, as determined by the State Labor Department in accordance with the Labor Law.

14. **Public Work Contracts – Hazardous Substances**

If this is a contract for public work, the Contractor agrees as follows:

- (a) the Contractor acknowledges that the County uses and/or produces various substances which may be classified as hazardous under OSHA's Hazard Communication Standard;
- (b) the Contractor recognizes the use of said substances by the County and acknowledges that the County has provided, or upon request will provide, the Contractor with a description of such substances which may be present in the area of the County's facility/facilities to which the Contractor may have accessed during the performance of this contract;
- (c) the Contractor acknowledges that the County has provided, or upon request will provide, suggestions for appropriate protective measures which should be observed when the Contractor is in the area of any such hazardous substances;
- (d) the Contractor agrees to be solely responsible for providing training and information to its employees regarding any such hazardous substances, as well as of any protective measures suggested by the County;
- (e) the Contractor agrees to be solely responsible to ensure that the Contractor's employees observe protective measures during the performance of their duties in the performance of the contract, and that all such protective measures will be at least as stringent as those suggested or which would have been suggested by the County;
- (f) in the event that the Contractor's performance of the work under this contract requires the use of any hazardous substances, the Contractor shall notify the County in advance of bringing in and/or using such substances in or upon County property and suggest to the County appropriate measures to be observed by the County, its officers and employees, and/or the public; and
- (g) in the event the Contractor fails in whole or in part to comply with the terms of this paragraph, the County shall have the right to interrupt the Contractor's work and/or terminate this contract, and the Contractor shall be prohibited from renewing such work until all applicable safety and health procedures and practices are implemented by the Contractor.

15. **Disputes**

Disputes involving this contract, including the breach or alleged breach thereof, may not be submitted to binding arbitration, but must, instead, be heard in the Essex County Supreme Court or any other court of competent jurisdiction within Essex County, New York.

16. **Non-Assignment**

This agreement may not be assigned, subcontracted, transferred, conveyed, sublet or otherwise disposed of in whole or in part, by the Contractor, without the prior written consent of the County, and any attempts to assign the contract without the County's written consent are null and void.

17. **No Collusion**

If this contract was awarded based upon the submission of bids, the Contractor warrants, under penalty of perjury, that:

- (a) its bid was arrived at independently and without collusion aimed at restricting competition; and
- (b) at the time Contractor submitted its bid, an authorized and responsible person executed and delivered to the County a non-collusive bidding certification on Contractor's behalf.

18. **International Boycott**

In accordance with Section 220-f of the Labor Law, if this contract exceeds \$5,000.00, the Contractor agrees, as a material condition of the contract, that neither the Contractor nor any substantially owned or affiliated person, firm, partnership or corporation, has participated, is participating, or shall participate in an International boycott in violation of the federal Export Administration Act of 1979, or regulations thereunder. If such contractor, or any of the aforesaid affiliates of Contractor, is convicted, or is otherwise found to have violated said laws or regulations upon the final determination of the United States Commerce Department or any other appropriate agency of the United States subsequent to the contract's execution, such contract, amendment or modification thereto shall be rendered forfeit and void. The Contractor shall so notify the County Manager within five (5) business days of such conviction, determination or disposition of appeal.

19. **County's Rights of Set-Off**

The County shall have all of its common law, equitable and statutory rights of set-off. These rights shall include, but not be limited to, the County's option to withhold for the purposes of set-off any moneys due to the Contractor under this agreement up to any amounts due and owing to the County with regard to this contract, any other contract with any County department or agency, including any contract for a term commencing prior to the term of this contract, plus any amounts due and owing to the County for any other reason, including, without limitation, tax delinquencies, fee delinquencies or monetary penalties relative thereto. The County shall exercise its set-off rights in accordance with normal County practices, including, in cases of set-off pursuant to an audit, the acceptance of such audit by the County Board of Supervisors or its designated representative.

20. **Contractor Defined**

Whenever the term "Contractor" is used in this agreement, such term shall include and apply to all employees, all officers, directors and agents, if any, of the Contractor.

21. **Amendment**

This agreement may not be amended, modified or renewed except by written agreement signed by the Contractor and the County.

22. **Ownership Of Work Products**

All final and written or tangible work products completed by the Contractor shall belong to the County. In the event of premature discontinuance of performance, the Contractor agrees to deliver all existing products and data files to the County.

23. **Executive Order Debarment/Suspension**

In the event that this contract involves the Contractor furnishing goods and services in excess of \$100,000.00, or constitutes a subaward to subrecipients, under any Federal program, grant or other funding source, then by executing this agreement the Contractor certifies that neither it nor any of its principals are suspended or debarred within the scope or meaning of Executive Orders 12549 and 12689, any Federal or State regulation implementing or codifying the same, or any other Federal or State law, rule or regulation.

24. **Health Insurance Portability and Accountability Act of 1996 (HIPAA)**

In the event that this contract involves the use or disclosure of protected health information within the meaning or application of the Health Insurance Portability and Accountability Act of 1996 (HIPAA), and the regulations thereunder, the following provisions of this paragraph shall apply.

- (a) **Definitions.** The terms used, but not otherwise defined, in this Agreement shall have the same meaning as given such terms in 45 CFR §160.103 and §164.501, as the same may be amended from time to time, including but not limited to the following.
- (1) "Business Associate" shall mean the Contractor, its officers, employees, agents and subcontractors.
 - (2) "Covered Entity" shall mean Essex County (the "County"), its departments, agencies, officers and employees.
 - (3) "Individual" shall have the same meaning as given such term in 45 CFR §164.501 and shall also include a person who qualifies as a personal representative in accordance with 45 CFR §164.502(g).
 - (4) "Privacy Rule" shall mean the Standards for Privacy of Individually Identifiable Health Information at 45 CFR Part 160 and Part 164, subparts A and E.
 - (5) "Protected Health Information" shall have the same meaning as given such term in 45 CFR §164.501, limited to the information created or received by Contractor from or on behalf of the County.
 - (6) "Required by law" shall have the same meaning as given such term in 45 CFR §164.501.
 - (7) "Secretary" shall mean the Secretary of the Department of Health and Human Services or his/her designee.
- (b) **Obligations and Activities of Contractor.**
Contractor agrees to:
- (1) not use or disclose Protected Health Information other than as permitted or required by this Agreement or as required by law;
 - (2) use appropriate safeguards to prevent use or disclosure of the Protected Health Information other than as provided for by this Agreement;
 - (3) mitigate, to the extent practicable, any harmful effect that is known, should have been known, and/or discovered to/by Contractor of a use or disclosure of Protected Health Information by Contractor in violation of the requirements of this Agreement;
 - (4) report to the County any use or disclosure of the Protected Health Information not provided for by this Agreement of which it becomes aware;
 - (5) ensure that any agent, including a subcontractor, to whom it provides Protected Health Information received from, or created or received by Contractor on behalf of the County agrees to the same restrictions and conditions that apply through this Agreement to Contractor with respect to such information;
 - (6) provide access, at the request of the County, and in the time and manner designated by the County or the Secretary, to Protected Health Information in a Designated Record Set, to the County or, as directed by the County, to an Individual in order to meet the requirements under 45 CFR §164.524;
 - (7) make any amendment(s) to Protected Health Information in a Designated Record Set that the County directs or agrees to pursuant to 45 CFR §164.526 at the request of the County or an Individual, and in the time and manner designated by the County or the Secretary;

- (8) make internal practices, books, and records, including policies and procedures and Protected Health Information, relating to the use and disclosure of Protected Health Information received from, or created or received by Contractor on behalf of, the County available to the County, and/or to the Secretary, in a time and manner designated by the County or by the Secretary, for purposes of the Secretary determining the County's compliance with the Privacy Rule;
- (9) document such disclosures of Protected Health Information and information related to such disclosures as would be required for the County to respond to a request by an Individual for an accounting of disclosures of Protected Health Information in accordance with 45 CFR §164.528;
- (10) provide to the County or an Individual, in time and manner designated by the County or the Secretary, information collected in accordance with the above subparagraph (b)(9) of this Agreement, to permit the County to respond to a request by an Individual for an accounting of disclosures of Protected Health Information in accordance with 45 CFR §164.528.

(c) Permitted Uses and Disclosures by Contractor.

Except as otherwise limited in this Agreement, Contractor may use or disclose Protected Health Information on behalf of, or to provide services to, the persons entitled to services under this Agreement:

- (1) solely for the purposes of performing Contractor's obligations under this Agreement, if such use or disclosure of Protected Health Information would not violate the Privacy Rule if done by the County or the minimum necessary policies and procedures of the County; or
- (2) provided that such use or disclosures are required by law; or
- (3) Contractor
 - (A) obtains written authorization(s) from the individual to which the information pertains permitting the specific uses or disclosures of such information to third persons,
 - (B) represents and agrees in writing with such individual that the information to be used and/or disclosed will remain confidential and used or further disclosed only as required by law or for the purposes specified in the written authorization(s), and
 - (C) such third persons agree in writing to notify the County as soon as practicable and in writing of any instances of which such third person(s) is/are aware in which the confidentiality of the information has been breached; or
- (4) provide Data Aggregation services to the County as permitted by 42 CFR §164.504(e)(2)(i)(B); or
- (5) report violations of law to appropriate Federal and State authorities, consistent with §164.502(j)(1).

(d) County To Inform Contractor of Privacy Practices and Restrictions.

The County agrees to notify the Contractor of any

- (1) limitation(s) in its notice of privacy practices of the County in accordance with 45 CFR §164.520, to the extent that such limitation may affect the Contractor's use or disclosure of Protected Health Information;
- (2) changes in, or revocation of, permission by Individual to use or disclose Protected Health Information, to the extent that such changes may affect the Contractor's use or disclosure of Protected Health Information; and/or
- (3) restriction to the use or disclosure of Protected Health Information that the

County has agreed to in accordance with 45 CFR §164.522, to the extent that such restriction may affect Contractor's use or disclosure of Protected Health Information.

(e) Permissible Requests by County.

The County shall not request Contractor to use or disclose Protected Health Information in any manner that would not be permissible under the Privacy Rule if done by the County; except that in the event that the services to be furnished by the Contractor under this Agreement requires data aggregation by the Contractor, the Contractor may use or disclose protected health information for such data aggregation or management and administrative activities of Contractor.

(f) Survival of Provisions.

The obligations of the Contractor under this paragraph 24 shall survive the expiration of the term of this Agreement and/or the termination of this Agreement, and said obligations shall remain effective and shall not terminate until all of the Protected Health Information provided by the County to Contractor, or created or received by Contractor on behalf of the County, is destroyed or returned to the County, or, if it is infeasible to return or destroy Protected Health Information, protections are extended to such information, in accordance with the termination provisions in subparagraph (g) below.

(g) Return or Destruction of Protected Health Information.

Except as otherwise provided below, upon termination of this Agreement for any reason, Contractor shall return or destroy all Protected Health Information received from the County, or created or received by Contractor on behalf of the County. This provision shall apply to Protected Health Information that is in the possession of subcontractors or agents of Contractor. Contractor shall retain no copies of the Protected Health Information.

In the event that Contractor determines that returning or destroying the Protected Health Information is infeasible, Contractor shall provide to the County notification of the conditions that make return or destruction infeasible. Upon determination by the County that return or destruction of Protected Health Information is infeasible, Contractor shall extend the protections of this Agreement to such Protected Health Information and limit further uses and disclosures of such Protected Health Information to those purposes that make the return or destruction infeasible, for so long as Contractor maintains such Protected Health Information.

(h) Termination for Cause.

Upon the County's knowledge of a material breach of this paragraph by Contractor, the County shall:

- (1) either:
 - (A) provide an opportunity for Contractor to cure the breach or end the violation and terminate this Agreement within the time specified by the County, or
 - (B) immediately terminate this Agreement if cure is not possible; and
- (2) report the violation to the Secretary.

(i) Miscellaneous.

- (1) Regulatory References. A reference in this Agreement to a section in the Privacy Rule means the section as in effect or as amended.
- (2) Amendment. The Parties agree to take such action as is necessary to amend this Agreement from time to time as is necessary for the County to comply with the requirements of the Privacy Rule and the Health Insurance Portability and Accountability Act of 1996, Pub. L. No. 104-191.

(3) Survival. The respective rights and obligations of Contractor under this paragraph 24 of this Agreement shall survive the termination of this Agreement.

(4) Interpretation. Any ambiguity in this Agreement shall be resolved to permit the County to comply with the Privacy Rule.

25. **Severability**

If any term or provision of this agreement or the application thereof to any person or circumstance shall to any extent be held invalid or unenforceable, the remainder of this agreement or the application of such term or provision to persons or circumstances other than those as to which it is held invalid or unenforceable, shall not be affected thereby and every other term and provision of this agreement shall be valid and be enforced to the fullest extent permitted by law.

26. **Entire Agreement**

This agreement is the entire agreement between the parties, and the same shall be construed in accordance with the laws of the State of New York.

27. **For Medicaid/Federal Health Care Related Work**

Excluded/Debarred Party Clause

The Vendor/Contractor represents and warrants that it, nor its employees or contractors, are not excluded from participation, and is not otherwise ineligible to participate, in a "federal health care program" as defined in 42 U.S.C. § 1320a-7b(f) or in any other government payment program.

In the event Vendor/Contractor, or one of its employees or contractors, is excluded from participation, or becomes otherwise ineligible to participate in any such program during the Term, Vendor/Contractor will notify Essex County in writing within three (3) days after such event. Upon the occurrence of such event, whether or not such notice is given to the Vendor/Contractor, Essex County reserves the right to immediately cease contracting with the Vendor/Contractor.

If Vendor/Contractor is an Employment Agency, the Vendor/Contractor represents and warrants that its employees and contractors are not excluded from participation in a "federal health care program" as defined in 42 U.S.C. § 1320a-7b(f) or debarred from participation in any federal or other program.

- The Vendor/Contractor further represents and warrants it will, at a minimum, check monthly all of its employees and subcontractors against:
- The General Services Administration's Federal Excluded Party List System (or any successor system),
- The United States Department of Health and Human Services' Office of the Inspector General's Lists of Excluded Individuals and Entities or any successor list,

The New York State Department of Health's Office of the Medicaid Inspector General's list of Restricted, Terminated or Excluded Individuals or Entities.

In the event an excluded party is discovered the Vendor/Contractor will notify Essex County in writing within three (3) days after such event. Upon the occurrence of such event, whether or not such notice is given to the Vendor/Contractor, Essex County reserves the right to immediately cease contracting with the Vendor/Contractor.

28. **Cooperative Purchasing (Piggybacking)**

Pursuant to General Municipal Law §103 and County Law §408-a, any political sub-

division or fire company (as both are defined in Section 100 of the GML) or district authorized to make purchases of apparatus, materials, equipment or supplies, or to contract for services related to the installation, maintenance or repair of apparatus, materials, equipment and supplies may make said purchases under this existing contract (Piggyback) provided, and on condition that this present contract was **LET TO THE LOWEST RESPONSIBLE BIDDER**. Therefore all terms and conditions under this contract are extended to other political sub-divisions and governmental entities.

Purchases under this contract by any other political sub-division other than Essex County shall be pursuant to the terms and conditions of Resolution No. 207 of 2013 dated July 1, 2013.

29. **New York State Sexual Harassment Laws**

Contractor certifies as to its self or its own organization, under penalty of perjury, that Contractor has and has implemented a written policy addressing sexual harassment prevention in the workplace and provides annual sexual harassment prevention training to all of its employees. Such policy shall, at a minimum, meet the requirements of Section 201-g of the New York State Labor Law. A model policy and training has been created by the New York State Department of Labor and can be found here:
<https://www.ny.gov/programs/combating-sexual-harassment-workplace>.

CONTRACTOR PROGRESS PAYMENT WAIVER, RELEASE AND DISCHARGE

PROJECT: _____

OWNER: ESSEX COUNTY

CONTRACTOR: _____

WITNESSETH:

The above-named Contractor, hereinafter referred to as the "Releasor", does, for and on behalf of itself, its' successors, assigns and all parties claiming any interest or right through the Releasor, hereby warrant, covenant and agree as follows:

1. Releasor is/was a Contractor relative to the above-referenced Project pursuant to a contract or other relationship for the performing and/or furnishing of work, labor, services, materials and/or equipment at the Project site or to be incorporated in said Project.

2. Whenever the term "Releasor" is used in this instrument such term shall mean: (a) the above-named Contractor, its, successors and assigns; (b) any and all sureties and all other guarantors of the Releasor on any payment, performance, labor and/or material bond or other undertaking; (c) all parties claiming any interest or right through the Releasor, including but not limited to subcontractors and suppliers; and (d) the respective officers, directors, principals, shareholders, agents, employees and attorneys of (a), (b) and (c).

3. Whenever the term "Releasees" is used in this instrument such term shall mean: (a) the above-named Owner, its' successors and assigns; (b) the Project Architect/Engineer; and (c) the respective officers, directors, principals, shareholders, agents, employees and attorneys of (a) and (b).

4. For and in consideration of the sum of \$_____, and other good and valuable consideration, which sum is acknowledged as being the full and total amount due or allegedly due or owing from the Releasees to the Releasor as of the date hereof, and the receipt of such payment being hereby acknowledged, the Releasor does waive, release and discharge the Releasees from any and all causes of action, suits, debts, claims, liens, accounts, bonds, contracts, damages, encumbrances, judgments and demands whatsoever and of every kind and nature, in law or in equity, which against the Releasees, jointly and/or severally, the Releasor ever had, now has, or might hereafter have, relating directly or indirectly to the work, labor, services, materials and/or equipment furnished and/or performed at the Project site, or incorporated or to be incorporated in said Project, as of the date hereof, including but not in any manner limited to the right of the Releasor to assert, file or claim any lien or other security interest in or upon the real and/or personal property of the Releasees.

5. The Releasor hereby agree to defend, indemnify, and hold harmless the Releasees from any and all damages, costs, expenses, demands, suits, liens and legal fees, directly or indirectly relating to any claim for compensation by any other party for work, labor, services, materials and/or equipment furnished and/or performed at the Project site, or which should have been so furnished or performed, or incorporated or to be incorporated in said Project, as of the date hereof, by the Releasor or by any other party claiming any interest or right through the Releasor.

6. The Releasor hereby certifies and warrants that it has fully paid for all work, labor, services, materials and/or equipment provided to it in connection with the Project and/or any contract relating thereto.

7. The Releasor hereby grants to the Releasees the right to review and audit any and books and records of the Releasor at any time for verification.

IN WITNESS WHEREOF this instrument has been executed this ____ day of _____
_____ 20 ____.

Releasor

By: _____

Print Name

Title

STATE OF NEW YORK)
) SS:
COUNTY OF ESSEX)

I, _____, being duly sworn, depose and say that: I reside at _____, and I hereby sign this instrument under penalty of perjury; I am the of the Releasor identified herein; I am fully authorized to execute this instrument on behalf of the Releasor; and I hereby affirm that the statements contained in this instrument are true and correct.

Vendor/Releasor Agent Sign Here

Sworn to before me this _____
day of _____, 20 ____

Notary Public

CONTRACTOR FINAL PAYMENT WAIVER, RELEASE AND DISCHARGE

PROJECT: _____

OWNER: _____

CONTRACTOR: _____

WITNESSETH:

The above-named Contractor, hereinafter referred to as the "Releasor", does, for and on behalf of itself, its' successors, assigns and all parties claiming any interest or right through the Releasor, hereby warrants, covenants and agrees as follows:

1. Releasor is/was a Contractor relative to the above-referenced Project pursuant to a contract or other relationship for the performing and/or furnishing of work, labor, services, materials and/or equipment at the Project site or to be incorporated in said Project.

2 Whenever the term "Releasor" is used in this instrument such term shall mean: (a) the above- named Contractor, its, successors and assigns; (b) any and all sureties and all other guarantors of the Releasor on any payment, performance, labor and/or material bond or other undertaking; (c) all parties claiming any interest or right through the Releasor, including but not limited to subcontractors and suppliers; and (d) the respective officers, directors, principals, shareholders, agents, employees and attorneys of (a), (b) and (c).

3. Whenever the term "Releasees" is used in this instrument such term shall mean: (a) the above-named Owner, its' successors and assigns; (b) Essex County, its agencies and departments (including but not limited to its Office for the Aging); and (c) the respective officers, directors, principals, shareholders, agents, employees and attorneys of (a) and (b).

4. For and in consideration of the sum of \$_____, and other good and valuable consideration, which sum is acknowledged as being the full, final and total amount due or allegedly due or owing from the Releasees to the Releasor as of the date hereof, and the receipt of such payment being hereby acknowledged, the Releasor does waive, release and discharge the Releasees from any and all causes of action, suits, debts, claims, liens, accounts, bonds, contracts, damages, encumbrances, judgments and demands whatsoever and of every kind and nature, in law or in equity, which against the Releasees, jointly and/or severally, the Releasor ever had, now has, or might hereafter have, relating directly or indirectly to the work, labor, services, materials and/or equipment furnished and/or performed at the Project site, or incorporated or to be incorporated in said Project, as of the date hereof, including but not in any manner limited to the right of the Releasor to assert, file or claim any lien or other security interest in or upon the real and/or personal property of the Releasees.

5. The Releasor hereby agree to defend, indemnify, and hold harmless the Releasees from any and all damages, costs, expenses, demands, suits, liens and legal fees, directly or indirectly relating to any claim for compensation by any other party for work, labor, services, materials and/or equipment furnished and/or performed at the Project site, or which should have been so furnished or performed, or incorporated or to be incorporated in said Project, as of the date hereof, by the Releasor or by any other party claiming any interest or right through the Releasor.

6. The Releasor hereby certifies and warrants that it has fully paid for all work, labor, services, materials and/or equipment provided to it in connection with the Project and/or any contract relating thereto.

7. The Releasor hereby grants to the Releasees the right to review and audit any and books and records of the Releasor at any time for verification.

IN WITNESS WHEREOF this instrument has been executed this ____ day of _____, 20__.

Releasor

By: _____

Print Name

Title

STATE OF NEW YORK)
) SS:
COUNTY OF ESSEX)

I, _____, being duly sworn, depose and say that: I reside at _____, and I hereby sign this instrument under penalty of perjury; I am the of the Releasor identified herein; I am fully authorized to execute this instrument on behalf of the Releasor; and I hereby affirm that the statements contained in this instrument are true and correct.

Vendor/Releasor Agent Sign Here

Sworn to before me this _____
day of _____, 20__.

Notary Public

CONTRACTORS AFFIDAVIT RELATIVE TO FINAL PAYMENT

PROJECT: _____

OWNER: ESSEX COUNTY

CONTRACTOR: _____

W I T N E S S E T H :

The herein below designated representative of the Contractor being duly sworn deposes and states:

1. He is duly authorized to sign this Affidavit on behalf of the Contractor.

2. That all payrolls, bills for materials and equipment, and other indebtedness connection with the work for which the County or the County's property might be responsible or encumbered have been paid or otherwise satisfied and there remain no further indebtedness or bills outstanding.

3. Attached hereto and made a part hereof is a valid certificate of insurance evidencing that insurance required by the contract documents will remain in full force after final payment is currently in effect and will not be cancelled or allowed to expire until at least 30 days prior written notice has been given to the owner.

4. Contractor knows of no substantial reason that the insurance will not be renewable to cover the period required by the contract documents.

5. Attached hereto and made a part hereof at Schedule B is a detailed list of all sub-contractors and material suppliers.

6. Contractor warrants and represents that all sub-contractors, material suppliers and fringe benefit trust funds for employees of contractor and sub-contractors on the portion of the project encompassed by the work, as well as all workers and persons employed in connection therewith have been paid in full for all labor and work and materials furnished.

7. Contractor releases and waives any and all public improvement lien rights which contractor has against the County.

IN WITNESS WHEREOF deponent has executed this Document on this _____ day
of _____, 20__.

Contractor

By: _____
Print Name

Title

STATE OF NEW YORK)
) SS:
COUNTY OF ESSEX)

I, _____, being duly sworn, depose and say that: I reside at _____, and I hereby sign this instrument under penalty of perjury; I am the of the Releasor identified herein; I am fully authorized to execute this instrument on behalf of the Releasor; and I hereby affirm that the statements contained in this instrument are true and correct.

Vendor/Releasor Agent Sign Here

Sworn to before me this ____
day of _____, 20__.

Notary Public

SUBCONTRACTOR/SUPPLIER PROGRESS PAYMENT WAIVER, RELEASE AND DISCHARGE

PROJECT: _____

OWNER: ESSEX COUNTY

CONTRACTOR: _____

SUBCONTRACTOR/SUPPLIER: _____

WITNESSETH:

The above-named Subcontractor/Supplier, hereinafter referred to as the "Releasor", does, for and on behalf of itself, its, successors, assigns and all parties claiming any interest or right through the Releasor, hereby warrants, covenants and agrees as follows:

1. Releasor is/was a subcontractor/supplier to the Contractor above-named relative to the above-referenced Project pursuant to a contract or other relationship for the performing and/or furnishing of work, labor, services, materials and/or equipment at the Project site or to be incorporated in said Project.

2. Whenever the term "Releasor" is used in this instrument such term shall mean: (a) the above-named Subcontractor/Supplier, its' successors and assigns; (b) any and all sureties and all other guarantors of the Releasor on any payment, performance, labor and/or material bond or other undertaking; (c) all parties claiming any interest or right through the Releasor; and (d) the respective officers, directors, principals, shareholders, agents, employees and attorneys of (a), (b) and (c).

3. Whenever the term "Releasees" is used in this instrument such term shall mean: (a) the above-named Contractor and all of its, sureties and other guarantors on any payment, performance, labor and/or material bond or other undertaking; (b) the abovenamed Owner, its, successors and assigns; (c) the Project Architect/Engineer; and (d) the respective officers, directors, principals, shareholders, agents, employees and attorneys of (a), (b) and (c).

4. For and in consideration of the sum of \$ _____, and other good and valuable consideration, which sum is acknowledged as being the full and total amount due or allegedly due or owing from the Releasees to the Releasor as of the date hereof, and the receipt of such payment being hereby acknowledged, the Releasor does waive, release and discharge the Releasees from any and all causes of action, suits, debts, claims, liens, accounts, bonds, contracts, damages, encumbrances, judgments and demands whatsoever and of every kind and nature, in law or in equity, which against the Releasees, jointly and/or severally, the Releasor ever had, now has, or might hereafter have, relating directly or indirectly to the work, labor, services, materials and/or equipment furnished and/or performed at the Project site, or incorporated or to be incorporated in said Project, as of the date hereof, including but not in any manner limited to the right of the Releasor to assert, file or claim any lien or other security interest in or upon the real and/or personal property of the Releasees.

5. The Releasor hereby agree to defend, indemnify, and hold harmless the Releasees from any and all damages, costs, expenses, demands, suits, liens and legal fees, directly or indirectly relating to any claim for compensation by any other party for work, labor, services, materials and/or equipment furnished and/or performed at the Project site, or which should have been so furnished

or performed, or incorporated or to be incorporated in said Project, as of the date hereof, by the Releasor or by any other party claiming any interest or right through the Releasor.

6. The Releasor hereby certifies and warrants that it has fully paid for all work, labor, services, materials and/or equipment provided to it in connection with the Project and/or any contract relating thereto.

7. The Releasor hereby grants to the Releasees the right to review and audit any and books and records of the Releasor at any time for verification.

IN WITNESS WHEREOF this instrument has been executed this ____ day of ____
_____, 20 .

Releasor

By: _____

(Print Name)

(Title)

STATE OF NEW YORK)
) SS:
COUNTY OF ESSEX)

I, _____, being duly sworn, depose and say that: I reside at _____, and I hereby sign this instrument under penalty of perjury; I am the of the Releasor identified herein; I am fully authorized to execute this instrument on behalf of the Releasor; and I hereby affirm that the statements contained in this instrument are true and correct.

Vendor/Releasor Agent Sign Here

Sworn to before me this ____
day of _____, 20 .

Notary Public

SUBCONTRACTOR/SUPPLIER FINAL WAIVER, RELEASE AND DISCHARGE

PROJECT: _____

OWNER: ESSEX COUNTY

CONTRACTOR: _____

SUBCONTRACTOR/SUPPLIER: _____

W I T N E S S E T H :

The above-named Subcontractor/Supplier, hereinafter referred to as the "Releasor", does, for and on behalf of itself, its, successors, assigns and all parties claiming any interest or right through the Releasor, hereby warrants, covenants and agrees as follows:

1. Releasor is/was a subcontractor/supplier to the Contractor above-named relative to the above-referenced Project pursuant to a contract or other relationship for the performing and/or furnishing of work, labor, services, materials and/or equipment at the Project site or to be incorporated in said Project.

2. Whenever the term "Releasor" is used in this instrument such term shall mean: (a) the above-named Subcontractor/Supplier, its' successors and assigns; (b) any and all sureties and all other guarantors of the Releasor on any payment, performance, labor and/or material bond or other undertaking; (c) all parties claiming any interest or right through the Releasor; and (d) the respective officers, directors, principals, shareholders, agents, employees and attorneys of (a), (b) and (c).

3. Whenever the term "Releasees" is used in this instrument such term shall mean: (a) the above-named Contractor and all of its, sureties and other guarantors on any payment, performance, labor and/or material bond or other undertaking; (b) the abovenamed Owner, its, successors and assigns; (c) the Project Architect/Engineer; and (d) the respective officers, directors, principals, shareholders, agents, employees and attorneys of (a), (b) and (c).

4. For and in consideration of the sum of \$ _____, and other good and valuable consideration, which sum is acknowledged as being the full, final and total amount due or allegedly due or owing from the Releasees to the Releasor as of the date hereof, and the receipt of such payment being hereby acknowledged, the Releasor does waive, release and discharge the Releasees from any and all causes of action, suits, debts, claims, liens, accounts, bonds, contracts, damages, encumbrances, judgments and demands whatsoever and of every kind and nature, in law or in equity, which against the Releasees, jointly and/or severally, the Releasor ever had, now has, or might hereafter have, relating directly or indirectly to the work, labor, services, materials and/or equipment furnished and/or performed at the Project site, or incorporated or to be incorporated in said Project, as of the date hereof, including but not in any manner limited to the right of the Releasor to assert, file or claim any lien or other security interest in or upon the real and/or personal property of the Releasees.

5. The Releasor hereby agree to defend, indemnify, and hold harmless the Releasees from any and all damages, costs, expenses, demands, suits, liens and legal fees, directly or indirectly relating to any claim for compensation by any other party for work, labor, services, materials and/or equipment furnished and/or performed at the Project site, or which should have been so furnished

or performed, or incorporated or to be incorporated in said Project, as of the date hereof, by the Releasor or by any other party claiming any interest or right through the Releasor.

6. The Releasor hereby certifies and warrants that it has fully paid for all work, labor, services, materials and/or equipment provided to it in connection with the Project and/or any contract relating thereto.

7. The Releasor hereby grants to the Releasees the right to review and audit any and books and records of the Releasor at any time for verification.

IN WITNESS WHEREOF this instrument has been executed this ____ day of _____, _____.

Releasor

By: _____

(Print Name)

(Title)

STATE OF NEW YORK)
) SS:
COUNTY OF _____)

I, _____, being duly sworn, depose and say that: I reside at _____, and I hereby sign this instrument under penalty of perjury; I am the of the Releasor identified herein; I am fully authorized to execute this instrument on behalf of the Releasor; and I hereby affirm that the statements contained in this instrument are true and correct.

Vendor/Releasor Agent Sign Here

Sworn to before me this ____
day of _____, 20__.

Notary Public

APPENDIX E



ESSEX COUNTY

Office of the Purchasing Agent

7551 Court Street, P.O. Box 217

Elizabethtown, NY 12932

518-873-3330/Fax 518-873-3339

GENERAL SPECIFICATIONS FOR PROCUREMENT CONTRACTS

Adopted May 20, 1999.

TABLE OF CONTENTS

PART I

Page

General Provisions

1.	Applicability	5
2.	Governing Law	5
3.	Appendix A / Insurance	5
4.	Ethics Compliance	5
5.	Conflict of Clauses.....	5
6.	Definition.	5

Bid Submission

7.	Bid Language & Currency.....	8
8.	Bid Opening	8
9.	Bid Submission	8
10.	Facsimile Submissions.....	8
11.	Authentication of Facsimile Bids.....	9
12.	Late Bids.	9
13.	Bid Contents	9
14.	Extraneous Terms	10
15.	Confidential/Trade Secret Materials	10
16.	Prevailing Wage Rates	10
17.	Taxes	12
18.	Expenses Prior to Award	12
19.	Advertising Bid Results	12
20.	Product References.....	12
21.	Recycled/Recovered Materials	12
22.	Products Manufactured in Public Institutions	13
23.	Pricing	13
24.	Drawings	13
25.	Site Inspection	14
26.	Samples	14
27.	Addenda/Interpretation	15

Bid Evaluation

28.	Bid Evaluation	15
29.	Conditional Bid	15
30.	Clarification/Revisions	16
31.	Prompt Payment Discounts	16
32.	Equivalent or Identical Bids	16
33.	Performance Qualifications	16
34.	Disqualification for Past Performance	16
35.	Quantity Changes Prior to Award	16
36.	Release of Bid Evaluation Materials	16
37.	Time Frame for Offers	16

Terms & Conditions

38.	Contract Creation/Execution	17
39.	Compliance With Laws, Etc.	17

40.	Modification of Terms	17
41.	Scope Changes	17
42.	Estimated Quantity Contracts	17
43.	Best Pricing Offer	18
44.	Purchase Orders	18
45.	Product Delivery	18
46.	Saturday & Holiday Deliveries	19
47.	Shipping/Receipt of Product	19
48.	Title & Risk of Loss	19
49.	Re-Weighing Product	19
50.	Product Substitution.....	20
51.	Rejected Product	20
52.	Installation	20
53.	Repaired or Replaced Product/Components	20
54.	On-Site Storage	20
55.	Employees/Subcontractors/Agents	20
56.	Assignment/Subcontractors	20
57.	Performance/Bid Bond	21
58.	Stop/Suspension of Work	21
59.	Cancellation	21
60.	Force Majeure	21
61.	Contract Billings	22
62.	Default – Authorized User	22
63.	Interest on Late Payments	22
64.	Remedies for Breach	23
65.	Assignment of Claim	23
66.	Toxic Substances	24
67.	Independent Contractor	24
68.	Security/Confidential	24
69.	Cooperation With Third Parties	24
70.	Contract Terms – Extension	24
71.	Warranties/Guarantees	24

PART II
Software/Technology
General Provisions

72.	Applicability	26
73.	Definitions – Part II	26

Terms & Conditions

74.	Software License Grant	27
75.	Enterprise License Option for Software	29
76.	Product Acceptance	31
77.	Audit of Licensed Product Usage	31
78.	Ownership/Title to Custom Products or Programming	32
79.	Proof of License	33
80.	Product Version	33
81.	Migration to Centralized Contract	33
82.	Notice of Product Discontinuance	33
83.	Reinstatement of Maintenance	33

84.	No Hard-stop/Passive License Monitoring	33
85.	Additional Warranties/Guarantees	34
86.	Indemnification	34
87.	Source Code Escrow for Licensed Products	34

PART I
General Provisions

1. APPLICABILITY The terms and conditions set forth herein are expressly incorporated in and applicable to all procurements and resulting procurement contracts let by the Office of the Essex County Purchasing Agent where incorporated by reference in its Bid Documents. The provisions herein shall govern such procurement or contract unless expressly modified or amended by the terms of a Bid Specifications, or a negotiated Contract/Clarification document, if any. Captions are intended as descriptive and are not intended to limit or otherwise restrict the terms and conditions set forth herein.

2. GOVERNING LAW The laws of the State of New York shall govern and apply to the procurement, any resulting contract and for determinations in a court of competent jurisdiction in New York of any and all disputes, litigation or interpretations arising from or connected with the procurement or contract, except where expressly superseded in a specific contract letting or where the Federal supremacy clause requires otherwise. These specifications are modeled after and upon the specifications developed and used by the New York State Office of General Services for procurements by New York State.

3. APPENDIX A / INSURANCE The mandatory terms for all Essex County contracts are expressly incorporated herein and in all bid documents and/or resulting contracts, such terms being set forth in Appendix A (*Standard Clauses for Essex County Contracts*). Insurance requirements are also attached and incorporated herein.

4. ETHICS COMPLIANCE All Bidders/Contractors and their employees must comply with the requirements of the *General Municipal Law*, the *Public Officers Law*, and other State codes, rules and regulations establishing ethical standards for the conduct of business with New York State and/or municipalities. In signing the bid, Bidder certifies full compliance with those provisions for any present or future dealings, transactions, sales, contracts, services, offers, relationships, etc., involving Essex County and/or its employees. Failure to comply with those provisions may result in disqualification from the bidding process, termination of contract, and/or other civil or criminal proceedings as required by law.

5. CONFLICT OF CLAUSES Conflicts between procurement or contract documents shall be resolved in the following order of precedence:

(a) **Appendix A** (*Standard Clauses for Essex County Contracts*)

(b) **Contract/Clarification Documents** Writing(s) setting forth the final agreements, clarifications, terms, statement of work and/or modifications between the Bid Documents and Contractors Bid or Mini-bid.

(c) **Bid Documents** - Bid Specifications prepared by Essex County

(d) **Contractors Bid or Proposal**

6. DEFINITIONS

Terms used in this document shall have the following meanings:

AGENCY OR AGENCIES Essex County, New York, acting by or through one or more departments, boards, commissions, offices or institutions of Essex County.

ANCILLARY PRODUCT: Product which is purchased or licensed on a restricted use basis in conjunction with the principal manufacturers Product being acquired (e.g. may be used only in combination, or by educational institutions for research use).

AUTHORIZED USER(S) Agencies, or any other entity authorized by Essex County to participate in Essex County procurement contracts (including but not limited to political subdivisions, public authorities, school districts and public benefit corporations), provided that each such Agency or other entity shall be held solely responsible for liabilities or payments due as a result of its participation. The term "Authorized User" shall include "Licensees."

BID OR BID PROPOSAL An offer or proposal submitted by a Bidder to furnish a described product or a solution or means of achieving a practical end, at a stated price for the stated contract term.

BIDDER Any individual or other legal entity, (including but not limited to partnership, firm or corporation) which submits a bid in response to a Bid Solicitation. The term Bidder shall also include "offeror" and/or "contractor".

BID DOCUMENTS Writings setting forth the scope, terms, conditions and technical specifications for a procurement of Product. Such writings typically include, but are not limited to: Invitation for Bids (IFB), Request for Quotation (RFQ), Request for Proposals (RFP), addenda or amendments thereto, and terms and conditions which are incorporated by reference, e.g. Appendix A (*Standard Clauses for NYS Contracts*), Appendix B, (*General Specifications*). Where these General Specifications are incorporated in negotiated contracts which have not been competitively bid, the term "Bid Documents" shall be deemed to refer to the terms and conditions set forth in the negotiated contract.

BID SOLICITATION The notice or advertisement of an intent to purchase a specified Product by or on behalf of Authorized User(s).

BID SPECIFICATION A written description drafted by Essex County or an authorized user setting forth the specific terms of the intended procurement, which may include: physical or functional characteristics, the nature of a commodity or construction item, any description of the work to be performed, Products to be provided, the necessary qualifications of the Bidder, the capacity and capability of the Bidder to successfully carry out the proposed contract, or the process for achieving specific results and/or anticipated outcomes or any other requirement necessary to perform work. Where these *General Specifications* are incorporated in negotiated contracts which have not been competitively bid, the term "Bid Specifications" shall be deemed to refer to the terms and conditions set forth in the negotiated contract.

CONTRACT The writing(s) which contain the agreement of the Commissioner and the Bidder/Contractor setting forth the total legal obligation between the parties as determined by applicable rules of law.

CONTRACT AWARD NOTIFICATION An announcement to Authorized Users that a contract has been established.

CONTRACTOR Any successful Bidder(s) to whom a contract has been awarded by the Purchasing Agent. The term "Contractor" includes Licensors.

COUNTY Essex County, New York.

EMERGENCY An urgent and unexpected requirement where health and public safety or the conservation of public resources is at risk.

ERROR CORRECTIONS Machine executable software code furnished by Contractor which corrects the Product so as to conform to the applicable warranties, performance standards and/or obligations of the Contractor.

GROUP A classification of Product (commodities, services or technology).

INVITATION FOR BIDS (IFB) A type of Bid Document which is most typically used where requirements can be stated and award will be made to the lowest responsive bid submitted by the most responsible Bidder(s).

LATE BID For purposes of bid openings held and conducted by the Essex County Purchasing Agent, a bid not received in such place as may be designated on the Bid Specifications or in the Office of the Essex County Purchasing Agent, at or before the date and time established in the Bid Specifications for the bid opening.

LETTER OF ACCEPTANCE A letter to the successful Bidder(s) indicating acceptance of its bid in response to a solicitation. Unless otherwise specified, the issuance of a Letter of Acceptance forms a contract but is not an order for Product, and Contractor should not take any action with respect to actual contract deliveries except on the basis of Purchase Orders sent from Authorized User(s).

LICENSED SOFTWARE Software transferred upon the terms and conditions set forth in the Contract. "Licensed Software" includes ancillary products, error corrections, upgrades, enhancements or new releases, and any deliverables due under a maintenance or service contract (e.g. patches, fixes, PTFs, programs, code or data conversion, or custom programming).

LICENSEE The County, or one or more Agencies or Authorized Users who acquire Product from Contractor by execution of a license in accordance with the terms and conditions of the Contract; provided that, for purposes of compliance with an individual license, the term "Licensee" shall be deemed to refer separately to the individual Authorized User(s) on whose behalf the license was executed who took receipt of the Product, and who shall be solely responsible for performance and liabilities incurred.

LICENSOR A Contractor who transfers rights in proprietary Product to Authorized Users in accordance with the rights and obligations specified in the Contract.

MULTIPLE AWARD A determination and award of a contract in the discretion of the Purchasing Agent to more than one responsive and responsible Bidder who meets the requirements of a specification, where the multiple award is made on the grounds set forth in the Bid Document in order to satisfy multiple factors and needs of Authorized Users (e.g., complexity of items, various manufacturers, differences in performance required to accomplish or produce required end results, production and distribution facilities, price, compliance with delivery requirements, geographic location or other pertinent factors).

NEW PRODUCT RELEASES (Product Revisions) Any commercially released revisions to the version of a Product as may be generally offered and available to Authorized Users. New releases involve a substantial revision of functionality from a previously released version of the Product.

PROCUREMENT RECORD Documentation by the Essex County Purchasing Agent of the decisions made and approach taken during the procurement process.

PRODUCT A deliverable under any Bid or Contract which may include commodities (including printing), services and/or technology. The term "Product" includes Licensed Software.

PURCHASE ORDER The County's fiscal form or format which is used when making a purchase.

REQUEST FOR PROPOSALS (RFP) A type of Bid Document which is used for procurements where factors in addition to cost are considered and weighted in awarding the contract and where the method of award is "best value", as defined by the County's Procurement Policy and New York Law.

REQUEST FOR QUOTATION (RFQ) A type of Bid Document which can be used when a formal bid opening is not required (e.g. discretionary, sole source, single source or emergency purchases).

RESPONSIBLE BIDDER A Bidder that is determined to have skill, judgment and integrity, and that is found to be competent, reliable, experienced and qualified financially, as determined by the Purchasing Agent.

RESPONSIVE BIDDER A Bidder meeting the specifications or requirements prescribed in the Bid Document or solicitation, as determined by the Purchasing Agent.

SINGLE SOURCE A procurement where two or more offerors can supply the required Product, and the Purchasing Agent may award the contract to one Bidder over the other.

SOLE SOURCE A procurement where only one offeror is capable of supplying the required Product.

Bid Submission

7. BID LANGUAGE & CURRENCY All offers (tenders), and all information and Product documentation required by the solicitation or provided as explanation thereof, shall be submitted in English. All prices shall be expressed, and all payments shall be made, in United States Dollars (\$ US). Any offers (tenders) submitted which do not meet the above criteria will be rejected.

8. BID OPENING Bids may, as applicable, be opened publicly. The Purchasing Agent reserves the right at anytime to postpone or cancel a scheduled bid opening.

9. BID SUBMISSION The submission of a bid will be construed to mean that the bidder is fully informed as to the extent and character of the supplies, material, or equipment required and a representation that the bidder can furnish the supplies, materials, or equipment satisfactorily in complete compliance with the specifications.

All bids shall comply with the following:

(a) Bids are to be packaged, sealed and submitted to the location stated in the Bid Specifications. Bidders are solely responsible for timely delivery of their bids to the location set forth in the Bid Specifications prior to the stated bid opening date/time.

(b) A bid return envelope, if provided with the Bid Specifications, should be used with the bid sealed inside. If the bid response does not fit into the envelope, the bid envelope should be taped onto the outside of the sealed box or package with the bid inside. If using a commercial delivery company which requires use of their shipping package or envelope, Bidders sealed bid, labeled as detailed below, should be placed within the shippers sealed envelope to ensure that the bid is not prematurely opened. All bids must have a label on the outside of the package or shipping container outlining the following information:

“BID ENCLOSED” (bold print, all capitals)
IFB or RFP Number
Bid Submission date and time

In the event that a Bidder fails to provide such information on the return bid envelope or shipping material, the County reserves the right to open the shipping package or envelope to determine the proper bid number or Product group, and the date and time of bid opening. Bidder shall have no claim against the receiving entity arising from such opening and such opening shall not affect the validity of the bid or the procurement. Notwithstanding the County’s right to open a bid to ascertain the foregoing information, Bidder assumes all risk of late delivery associated with the bid not being identified, packaged or labeled in accordance with the foregoing requirements.

10. FACSIMILE SUBMISSIONS Unless specifically authorized by the terms of the Bid Specifications,

facsimile bids ARE PROHIBITED AND SHALL NOT BE ACCEPTED. Where the bid specifications are silent as to the submission of bids by facsimile, no fax bids shall be permitted or accepted. Where specifically authorized, the following rules and conditions apply:

- (a) FAX number(s) indicated in the Bid Specifications must be used.
- (b) Access to the facsimile machine(s) is on a "first come, first serve" basis, and the Purchasing Agent bears no liability or responsibility and makes no guarantee whatsoever with respect to the Bidders access to such equipment at any specific time.
- (c) Bidders are solely responsible for submission and receipt of the entire facsimile bid by the Essex County Purchasing Agent prior to bid opening and must include on the first page of the transmission the total number of pages transmitted in the bid, including the cover page. Incomplete, ambiguous or unreadable transmissions in whole or in part may be rejected at the sole discretion of the Purchasing Agent.
- (d) Facsimile bids are fully governed by all conditions outlined in the Bid Documents and must be submitted on forms or in the format required in the Bid Specifications, including the executed signature page and acknowledgment.

11. AUTHENTICATION OF FACSIMILE BIDS The act of submitting a bid by facsimile transmission, when, as and if specifically authorized, including an executed signature page, shall be deemed a confirming act by Bidder which authenticates the signing of the bid.

12. LATE BIDS Any bid received at the specified location after the time specified will be considered a late bid. A late bid shall not be considered for award unless acceptance of the late bid is in the best interests of Essex County and either (a) no timely bids meeting the requirements of the Bid Documents are received, or (b) in the case of a multiple award, an insufficient number of timely bids were received to satisfy the multiple award. Delays in United States mail deliveries or any other means of transmittal, including couriers or agents of Essex County, shall not excuse late bid submissions. Otherwise, all late bids will not be considered and will be returned unopened to the bidder. The bidder assumes the risk of any delay in the mail or in the handling of the mail by employees of the County. Whether sent by mail or by means of personal delivery, the bidder assumes responsibility for having his bid deposited on time at the place specified.

13. BID CONTENTS Bids must be complete and legible. All bids must be signed. All information required by the Bid Specifications must be supplied by the Bidder on the forms or in the format specified in the Bid Specifications. No alteration, erasure or addition is to be made to the Bid Documents. Changes may be ignored by the Purchasing Agent or may be grounds for rejection of the bid. Changes, corrections and/or use of white-out in the bid or Bidders response portion of the Bid Document must be initialed by an authorized representative of the Bidder. Bidders are cautioned to verify their bids before submission, as amendments to bids or requests for withdrawal of bids received by the Purchasing Agent after the time specified for the bid opening, may not be considered. All lines must have an indication of bidders response whether it be "o", "N/A" or a dollar figure. All lines must be filled in to indicate bidder acknowledgment of the request. Bids that do not have all applicable lines filled in on bid sheet may be disqualified as a non-responsive bid. The Purchasing Agent shall not assume there is "no charge" when lines are left empty.

Bidders must submit with bid detailed specifications, circulars, warranties and all necessary data on items he proposes to furnish. This information must show clearly that the item offered meets all detailed specifications herein. The Purchasing Agent reserves the right to reject any bid if its compliance with the specifications is not clearly evident. If item offered differs from the provisions contained in these specifications such differences must be explained in detail, and bid will receive careful consideration if such deviations do not depart from the intent of these specifications and are to the best interests of Essex County as interpreted by the Purchasing Agent of Essex County.

It is the responsibility of the bidder to offer a product that meets the specifications of the manufacturer model as listed.

All stock electrical items must be listed and approved by Underwriters' Laboratories, Inc.

14. EXTRANEOUS TERMS Bids must conform to the terms set forth in the Bid Documents, as extraneous terms or material deviations (including additional, inconsistent, conflicting or alternative terms) may render the bid non-responsive and may result in rejection of the bid.

Extraneous term(s) submitted on standard, pre-printed forms (including but not limited to: product literature, order forms, license agreements, contracts or other documents) which are attached or referenced with the submission shall not be considered part of the bid, but shall be deemed included for informational or promotional purposes only.

Only those extraneous terms which meet all the following requirements will be considered as having been submitted as part of the Bid:

- (a) Each proposed extraneous term (addition, counter-offer, deviation, or modification) must be specifically enumerated in a writing which is not part of a pre-printed form; and
- (b) The writing must identify the particular specification requirement (if any) which Bidder rejects or proposes to modify by inclusion of the extraneous term; and
- (c) The Bidder shall enumerate the proposed addition, counteroffer, modification or deviation from the Bid Document, and the reasons therefore.

No extraneous term(s), whether or not deemed "material," shall be incorporated into a contract unless the Purchasing Agent expressly accepts each such term(s) in writing. Acceptance and/or processing of the Bid shall not constitute such written acceptance of Extraneous Term(s).

15. CONFIDENTIAL / TRADE SECRET MATERIALS Confidential, trade secret or proprietary materials as defined by the laws of the State of New York must be clearly marked and identified as such upon submission. Bidders/Contractors intending to seek an exemption from disclosure of these materials under the *Freedom of Information Law* must request the exemption in writing, setting forth the reasons for the claimed exemption, at the time of submission. Acceptance of the claimed materials does not constitute a determination on the exemption request, which determination will be made in accordance with statutory procedures.

16. PREVAILING WAGE RATES - Public Works and Building Services Contracts If any portion of work being bid is subject to the prevailing wage rate provisions of Labor Law, the following shall apply:

(a) "Public Works" and "Building Services" – Definitions

i. Public Works *Labor Law* Article 8 applies to contracts for public improvement in which laborers, workers or mechanics are employed on a "public works" project (distinguished from public "procurement" or "service" contracts). The State, a public benefit corporation, a municipal corporation (including a school district), or a commission appointed by law must be a party to the contract. The wage and hours provision applies to any work performed by contractor or subcontractors.

ii. Building Services *Labor Law* Article 9 applies to contracts for building service work over \$1,500 with a public agency, which 1) involve the care or maintenance of an existing building, or 2) involve the transportation of office furniture or equipment to or from such building, or 3) involve the transportation and delivery of fossil fuel to such building, and 4) the principal purpose of which is to furnish services through use of building service employees.

(b) Prevailing Wage Rate Applicable to Bid Submissions A copy of the applicable prevailing wage rates to be paid or provided are attached to this solicitation. Bidders must submit bids which are based upon the prevailing hourly wages, and supplements in cash or equivalent benefits (i.e., fringe benefits and any cash or non-cash compensation which are not wages, as defined by law) that equal or exceed the applicable prevailing wage rate(s) for the location where the work is to be performed. Where the Bid Documents require the Bidder to enumerate hourly wage rates in the bid, Bidders may not submit bids based upon hourly wage rates and supplements below the applicable prevailing wage rates as established by the New York State Department of Labor. **Bids which fail to comply with this requirement will be disqualified.**

(c) Wage Rate Payments / Changes During Contract Term The wages to be paid under any resulting contract shall not be less than the prevailing rate of wages and supplements as set forth by law. It is required that the Contractor keep informed of all changes in the Prevailing Wage Rates during the contract term that apply to the classes of individuals supplied by the contractor on any projects which result from this contract which are subject to the provisions of the *Labor Law*. Contractor is solely liable for and must pay such required prevailing wage adjustments during the contract term as required by law.

(d) Public Posting & Certified Payroll Records In compliance with Article 8, Section 220 of the *Labor Law*, as amended by Chapter 565 of the Laws of 1997:

i. Posting The Contractor must publicly post on the work site, in a prominent and accessible place, a legible schedule of the prevailing wage rates and supplements.

ii. Payroll Records Contractors and sub-contractors must keep original payrolls or transcripts subscribed and affirmed as true under the penalties of perjury as required by law. For public works contracts over \$25,000 where the contractor maintains no regular place of business in New York State, such records must be kept at the work site. For building services contracts, such records must be kept at the work site while work is being performed.

iii. Submission of Certified Payroll Transcripts for Public Works Contracts Only Contractors and sub-contractors on public works projects must submit monthly payroll transcripts to Essex County which has prepared or directs the preparation of the plans and specifications for a public works project, as set forth in the Bid Specifications. For mini-bid solicitations, the payroll records must be submitted to the entity preparing the agency mini-bid project specification. For "agency specific" bids, the payroll records should be submitted to the entity issuing the purchase order. For all other Essex County procurement contracts, such records should be submitted to the individual agency issuing the purchase order(s) for the work. Upon mutual agreement of the Contractor and Essex County, the form of submission may be submitted in a specified disk format acceptable to the Department of Labor so long as: 1) the contractor/subcontractor retains the original records; and, (2) an original signed letter by a duly authorized individual of the contractor or subcontractor attesting to the truth and accuracy of the records accompanies the disk. **This provision does not apply to building services contracts.**

iv. Records Retention Contractors and subcontractors must preserve such certified transcripts for a period of three years from the date of completion of work on the awarded contract.

(e) Days Labor - Defined for Article 8, Public Works (For Purposes of Article 8 of the Labor Law) No laborer, worker or mechanic in the employ of the contractor, subcontractor or other person doing or contracting to do all or part of the work contemplated by the contract shall be permitted or required to work more than eight hours in any one calendar day or more than five days in any one week except in cases of extraordinary emergency including fire, flood or danger to life or property. "Extraordinary emergency" shall be deemed to include situations in which sufficient laborers, workers and mechanics cannot be employed to carry on public work expeditiously as a result of such

restrictions upon the number of hours and days of labor and the immediate commencement or prosecution or completion without undue delay of the public work is necessary in the judgment of the Essex County Purchasing Agent for the preservation of the contract site or for the protection of the life and limb of the persons using the contract site.

17. TAXES

(a) Unless otherwise specified in the Bid Specifications or set forth in this clause, the quoted bid price includes all taxes applicable to the transaction.

(b) Purchases made by Essex County and certain non-County Authorized Users are exempt from New York State and local sales taxes and, with certain exceptions, federal excise taxes. To satisfy the requirements of the New York State Sales tax exemption, either the Purchase Order issued by a County Agency or the invoice forwarded to authorize payment for such items will be sufficient evidence that the sale by the Contractor was made to the County, an exempt organization under Section 1116 (a) (1) of the *Tax Law*. Non-County Authorized Users must offer their own proof of exemption where required. No person, firm or corporation is, however, exempt from paying the State Truck Mileage and Unemployment Insurance or Federal Social Security taxes, which remain the sole responsibility of the Bidder/Contractor. For tax free transactions under the Internal Revenue Code, the Essex County Registration Number is 14 6002889.

(c) Purchases by Authorized Users other than Essex County may be subject to such taxes, and in those instances the tax should be computed based on the bid price and added to the invoice submitted to such entity for payment.

18. EXPENSES PRIOR TO AWARD Essex County is not liable for any costs incurred by a Bidder in the preparation and production of a bid or for any work performed prior to contract award and/or issuance of an approved Purchase Order.

19. ADVERTISING BID RESULTS A Bidder in submitting a bid agrees not to use the results therefrom as a part of any commercial advertising without the prior written approval of the Purchasing Agent. In addition to any other sanctions or remedies available to it in law or equity, the Purchasing Agent may suspend from bidding on its requirements or terminate a contract of any Bidder/Contractor who violates the terms of this clause.

20. PRODUCT REFERENCES

(a) **“Or Equal”** On all Bid Specifications the words “or equal” are understood to apply where a copyright brand name, trade name, catalog reference, or patented Product is referenced. References to such specific Product are intended as descriptive, not restrictive, unless otherwise stated. Comparable Product will be considered if proof of compatibility is provided, including appropriate catalog excerpts, descriptive literature, specifications and test data, etc. The Purchasing Agents decision as to acceptance of the Product as equal shall be final.

(b) **Discrepancies in References** In the event of a discrepancy between the model number referenced in the Bid Specifications and the written description of the Products therein which cannot be reconciled, with respect to such discrepancy, then the written description shall prevail.

21. RECYCLED OR RECOVERED MATERIALS Upon the conditions specified in the Bid Specifications and in accordance with the laws of the State of New York, Contractors are encouraged to use recycled or recovered materials in the manufacture of Products and packaging to the maximum extent practicable without jeopardizing the performance or intended end use of the Product or packaging unless such use is precluded due to health, welfare, safety requirements or in the Bid

Specifications. Where such use is not practical, suitable, or permitted by the Bid Specifications, Contractor shall deliver new materials in accordance with the "Warranties & Guaranties" set forth below.

Refurbished or remanufactured components or items may only be accepted at the discretion of the Purchasing Agent, or upon the conditions set forth in the Bid Specifications.

Items with recycled, recovered, refurbished or remanufactured content must be identified in the bid or will be deemed new Product.

22. PRODUCTS MANUFACTURED IN PUBLIC INSTITUTIONS Bids offering Products which are manufactured or produced in public institutions will be rejected.

23. PRICING

(a) Unit Pricing If required by the Bid Specifications, the Bidder should insert the price per unit specified and the price extensions in decimals, not to exceed four places for each item, in the bid. In the event of a discrepancy between the unit price and the extension, the unit price shall govern unless, in the sole judgment of the Purchasing Agent, such unit pricing is obviously erroneous.

(b) Net Pricing Prices must be net, including transportation, customs, tariff, delivery and other charges fully prepaid by the Contractor to the destination(s) indicated in the Bid Specifications, subject only to the cash discount. If the award is to be made on another basis, transportation and other charges must be prepaid by the Contractor and added to the invoice as a separate item, unless otherwise required in the Bid Specifications.

(c) "No Charge" Bid When bids are requested on a number of Products as a group or Lot, a Bidder desiring to bid "no charge" on a Product in the grouping or Lot must clearly indicate such. Otherwise, such bid may be considered incomplete and be rejected, in whole or in part, at the discretion of the Purchasing Agent.

If a price is written in numbers and alpha, the alpha will govern.

Prices shall be net FOB any point in Essex County, New York. Price quoted shall include all delivery costs. Prices shall be net, including transportation and delivery charges fully prepaid by the successful bidder to destination indicated in the proposal. If award is made on any other basis, transportation charges must be prepaid by the successful bidder and added to the invoice as a separate item. In any case, title shall not pass until items have been delivered and accepted by the County.

24. DRAWINGS

(a) Drawings Submitted With Bid When the Bid Specifications require the Bidder to furnish drawings and/or plans, such drawings and/or plans shall conform to the mandates of the Bid Documents and shall, when approved by the Purchasing Agent, be considered a part of the bid and of any resulting contract. All symbols and other representations appearing on the drawings shall be considered a part of the drawing.

(b) Drawings Submitted During the Contract Term Where required by the Bid Specifications to develop, maintain and deliver diagrams or other technical schematics regarding the scope of work, Contractor shall be required to develop, maintain, deliver and update such drawings on an ongoing basis at no additional charge. Contractor shall be responsible for updating drawings and plans during the contract term to reflect additions, alterations, and deletions. Such drawings and diagrams shall be delivered to the Authorized

Users representative as required by the Bid Specifications. Where required, Contractor shall furnish to Authorized User in a timely manner the required drawings representing the then current, "as modified" condition of all product included in the scope of work.

(c) Accuracy of Drawings Submitted All drawings shall be neat and professional in manner and shall be clearly labeled as to locations and type of product, connections and components. Drawings and diagrams are to be in compliance with accepted drafting standards. Acceptance or approval of such plans shall not relieve the Contractor from responsibility for design or other errors of any sort in the drawings or plans, or from its responsibility for performing as required, furnishing product, services or installation, or carrying out any other requirements of the intended scope of work.

25. SITE INSPECTION Where Bidder is required by the Bid Specifications to deliver or install Product, or to service installed product(s) or equipment, Bidder shall be given an opportunity and shall be required to inspect the site prior to submission of the Bid, including environmental or other conditions or pre-existing deficiencies in the installed product, equipment or environment, which may affect Bidders ability to deliver, install or otherwise provide the required product. All inquiries regarding such conditions may only be made in writing. Bidder shall be deemed to have knowledge of any deficiencies or conditions which such inspection or inquiry might have disclosed, and to have included the costs of repair in its bid. Bidder must provide a detailed explanation of work intended to be performed under this clause. Bidder shall be required to remedy any pre-existing deficiencies or conditions at the commencement of the contract term. Reimbursement for the cost of repairing the conditions or deficiencies shall be separately enumerated in the bid.

26. SAMPLES

(a) Standard Samples Bid Specifications may indicate that the Product to be purchased must be equal to a standard sample on display in a place designated by the Purchasing Agent and such sample will be made available to the Bidder for examination prior to the opening date. Failure by the Bidder to examine such sample shall not entitle the Bidder to any relief from the conditions imposed by the Bid Documents.

(b) Bidder Supplied Samples The Purchasing Agent reserves the right to request from the Bidder/Contractor a representative sample(s) of the Product offered at any time prior to or after award of a contract. Unless otherwise instructed, samples shall be furnished within the time specified in the request. Untimely submission of a sample may constitute grounds for rejection of bid or cancellation of the Contract. Samples must be submitted free of charge and be accompanied by the Bidders name and address, any descriptive literature relating to the Product and a statement indicating how and where the sample is to be returned. Where applicable, samples must be properly labeled with the appropriate bid or Essex County contract reference.

A sample may be held by the Purchasing Agent during the entire term of the contract and for a reasonable period thereafter for comparison with deliveries. At the conclusion of the holding period the sample, where feasible, will be returned as instructed by the Bidder, at the Bidders expense and risk. Where the Bidder has failed to fully instruct the Purchasing Agent as to the return of the sample (i.e. mode and place of return, etc.) or refuses to bear the cost of its return, the sample shall become the sole property of the receiving entity at the conclusion of the holding period.

(c) Enhanced Samples When an approved sample exceeds the minimum specifications, all Product delivered must be of the same enhanced quality and identity as the sample. Thereafter, in the event of a Contractors default, the Purchasing Agent may procure a commodity substantially equal to the enhanced sample from other sources, charging the Contractor for any additional costs incurred.

(d) Conformance with Sample(s) Submission of a sample (whether or not such sample is tested by, or for, the Purchasing Agent) and approval thereof shall not relieve the Contractor from full compliance with all conditions and terms, performance related and otherwise, specified in the Bid Documents. If in the judgment of the Purchasing Agent the sample or product submitted is not in accordance with the specifications or testing requirements prescribed in the Bid Documents, the Purchasing Agent may reject the bid. If an award has been made, the Purchasing Agent may cancel the contract at the expense of the Contractor.

(e) Testing All samples are subject to tests in the manner and place designated by the Purchasing Agent, either prior to or after contract award. Unless otherwise stated in the Bid Specifications, Bidder Samples consumed or rendered useless by testing will not be returned to the Bidder.

27. ADDENDA / INTERPRETATION No verbal interpretation of the intent of any of the specifications or other Contract Documents will be made before receipt of bids. Requests for interpretations prior to receipt of bids must be presented, in writing, to the Purchasing Agent, 100 Court Street, P.O. Box 217, Elizabethtown, NY 12932, and to be given consideration must be received by the Purchasing Agent at least seven (7) days prior to the date set for the opening of bids.

Any interpretation, and any additional information or instruction will, if issued, be in the form of a written Addendum or Addenda sent to all holders of Contract Documents at the addresses furnished therefor, at least five (5) days prior to the date of the opening of bids.

Failure of any bidder to receive any Addenda shall not relieve such bidder from any obligation under this bid as submitted. All Addenda so issued shall become a part of the Contract Documents.

Bid Evaluation

28. BID EVALUATION The Purchasing Agent reserves the right to accept or reject any and all bids, or separable portions of offers, and waive technicalities, irregularities, and omissions if the Purchasing Agent determines the best interests of the County will be served. The Purchasing Agent, in his/her sole discretion, may accept or reject illegible, incomplete or vague bids and his/her decision shall be final. A conditional or revocable bid which clearly communicates the terms or limitations of acceptance may be considered and contract award may be made in compliance with the Bidders conditional or revocable terms in the offer.

Where a bidder is requested to submit a bid on individual items and/or on a total sum or sums, the right is reserved to award bids on individual items or on total sums. The County reserves the right to award in whole or in part based on the lowest responsible bid.

The following three items will automatically render a bid unacceptable to Essex County:

- a. Failure to sign bid proposal page.
- b. Failure to include necessary bid deposit (as required).
- c. Failure to sign and submit non-collusive bidding certificate.

It shall be fully understood that any deviations from the inclusion of the above items will be grounds to see the bid as non-compliant and will not be considered for award.

The Purchasing Agent reserves the right to reject such bids, as in his opinion, are incomplete, conditional, obscure, or which contain irregularities of any kind including unbalanced bids. One in which the amount bid for one or more separate items is substantially out of line with the current market prices for the materials and/or work covered thereby.

29. CONDITIONAL BID Unless the Bid Specifications provides otherwise, a bid is not rendered non-responsive if the Bidder specifies that the award will be accepted only on all or a specified group of items or Product included in the specification. It is understood that nothing herein shall be deemed to change or alter the method of award contained in the Bid Documents.

30. CLARIFICATIONS / REVISIONS Prior to award, the Purchasing Agent reserves the right to seek clarifications, request bid revisions, or to request any information deemed necessary for proper evaluation of bids from all Bidders deemed to be eligible for contract award. Failure to provide requested information may result in rejection of the bid.

31. PROMPT PAYMENT DISCOUNTS While prompt payment discounts will not be considered in determining the low bid, the Purchasing Agent may consider any prompt payment discount in resolving bids which are otherwise tied. However, any notation indicating that the price is net, (e.g. net 30 days), shall be understood to mean only that no prompt payment discount is offered by the Bidder. The imposition of service, interest, or other charges, except pursuant to the provisions of Article 11_A of the *State Finance Law*, which are applicable in any case, may render the bid non-responsive and may be cause for its rejection.

32. EQUIVALENT OR IDENTICAL BIDS In the event two offers are found to be substantially equivalent, price shall be the basis for determining the award recipient. If two or more Bidders submit substantially equivalent bids as to pricing or other factors, the decision of the Purchasing Agent to award a contract to one or more of such Bidders shall be final.

33. PERFORMANCE QUALIFICATIONS The Purchasing Agent reserves the right to investigate or inspect at any time whether or not the Product, qualifications or facilities offered by the Bidder/Contractor meet the requirements set forth in the Bid Documents. Contractor shall at all times during the contract term remain responsible and responsive. A Bidder/Contractor must be prepared, if requested by the Purchasing Agent, to present evidence of experience, ability and financial standing, as well as a statement as to plant, machinery and capacity of the manufacturer for the production, distribution and servicing of the Product bid. If the Purchasing Agent determines that the conditions and terms of the Bid Documents or Contract are not complied with, or that items or Product proposed to be furnished do not meet the specified requirements, or that the qualifications, financial standing or facilities are not satisfactory, or that performance is untimely, the Purchasing Agent may reject such bid or terminate the contract. Nothing in the foregoing shall mean or imply that it is obligatory upon the Purchasing Agent to make an investigation either before or after award of a contract, but should such investigation be made, it in no way relieves the Bidder/Contractor from fulfilling all requirements and conditions of the contract.

34. DISQUALIFICATION FOR PAST PERFORMANCE Bidder may be disqualified from receiving awards if Bidder, or anyone in Bidders employment, has previously failed to perform satisfactorily in connection with public bidding or contracts.

35. QUANTITY CHANGES PRIOR TO AWARD The Purchasing Agent reserves the right, at any time prior to the award of a specific quantity contract, to alter in good faith the quantities listed in the Bid Specifications to conform with requirements. In the event such right is exercised, the lowest responsible Bidder meeting specifications will be advised of the revised requirements and afforded an opportunity to extend or reduce its bid price in relation to the changed quantities. Refusal by the low Bidder to so extend or reduce its bid price may result in the rejection of its bid and the award of such contract to the lowest responsible Bidder who accepts the revised requirements.

36. RELEASE OF BID EVALUATION MATERIALS Requests concerning the evaluation of bids may be submitted under the *Freedom of Information Law*. Information, other than the Bid Tabulation, shall be released as required by law after contract award. Written requests should be directed to the Purchasing Agent.

37. TIME FRAME FOR OFFERS The Purchasing Agent reserves the right to make awards within sixty (60) days after the date of the bid opening, during which period, bids must remain firm and cannot be withdrawn. If, however, an award is not made within the sixty (60) day period, bids shall remain firm until such later time as either a contract is awarded or the Bidder delivers to the Purchasing Agent written notice of the withdrawal of its bid. Any bid which expressly states therein that acceptance must be made within a shorter specified time, may at the sole discretion of the Purchasing Agent, be accepted or rejected.

TERMS & CONDITIONS

38. CONTRACT CREATION / EXECUTION Except as may be otherwise provided by law or by the Purchasing Agent, upon receipt of all required approvals a Contract shall be deemed executed and created with the successful Bidder(s) upon the Purchasing Agent's mailing or electronic communication to the address on the bid of (a) a Letter of Acceptance and (b) a fully executed contract, or (c) a Purchase Order authorized by the Purchasing Agent.

39. COMPLIANCE WITH LAWS, ETC. The Bidder shall comply with all the provisions of the laws of the State of New York and of the United States of America which affect municipalities and municipal contracts, and any and all State and Federal rules and regulation, and of amendments and additions thereto, insofar as the same shall be applicable to any contract awarded hereunder with the same force and effect as if set forth at length herein. The Bidder's special attention is called to the following laws: *General Municipal Law* Section 1 03-d, *State Finance Law* Section 167-b prohibiting the purchase of tropical hardwood products, and the New York State Public Employee Safety & Health Act of 1980.

40. MODIFICATION OF TERMS The terms and conditions set forth in the Contract shall govern all transactions by Authorized User(s) under this Contract. The Contract may only be modified or amended upon mutual written agreement of the Purchasing Agent and Contractor.

The Contractor may, however, offer Authorized User(s) more advantageous pricing, payment, or other terms and conditions than those set forth in the Contract. In such event, a copy of such terms shall be furnished to the Authorized User(s) and Purchasing Agent by the Contractor.

Other than where such terms are more advantageous for the Authorized User(s) than those set forth in the Contract, no alteration or modification of the terms of the Contract, including substitution of Product, shall be valid or binding against Authorized User(s) unless authorized by the Purchasing Agent or specified in the Contract Award Notification. No such alteration or modification shall be made by unilaterally affixing such terms to Product upon delivery (including, but not limited to, attachment or inclusion of standard pre-printed order forms, product literature, "shrink wrap" terms accompanying software upon delivery, or other documents) or by incorporating such terms onto order forms, purchase orders or other documents forwarded by the Contractor for payment, notwithstanding Authorized Users subsequent acceptance of Product, or that Authorized User has subsequently processed such document for approval or payment.

41. SCOPE CHANGES The Purchasing Agent reserves the right, unilaterally, to require, by written order, changes by altering, adding to or deducting from the contract specifications, such changes to be within the general scope of the contract. The Purchasing Agent may make an equitable adjustment in the contract price or delivery date if the change affects the cost or time of performance.

With respect to any specific quantity stated in the contract, the Purchasing Agent reserves the right after award to order up to 20% more or less (rounded to the next highest whole number) than the specific quantities called for in the contract. Notwithstanding the foregoing, the Purchasing Agent may purchase greater or lesser percentages of contract quantities should the Purchasing Agent and Contractor so agree.

42. ESTIMATED QUANTITY CONTRACTS Estimated quantity contracts are expressly agreed and

understood to be made for only the quantities, if any, actually ordered during the contract term. No guarantee of any estimated quantity(s) is implied or given. Unless otherwise set forth in the Bid Specifications, contracts for services and technology are completely voluntary as to use, and therefore no quantities are guaranteed.

43. BEST PRICING OFFER During the contract term, if substantially the same or a smaller quantity of a Product is sold by the Contractor outside of this contract vehicle upon the same or similar terms and conditions as that of this contract at a lower price, the price under this contract shall be immediately reduced to the lower price.

44. PURCHASE ORDERS Unless otherwise authorized in writing by the Purchasing Agent, no Products are to be delivered or furnished by Contractor until transmittal of an official Purchase Order from the Authorized User requiring the Product. Unless terminated or canceled pursuant to the authority vested in the Purchasing Agent, Purchase Orders shall be effective and binding upon the Contractor when placed in the mail or electronically transmitted prior to the termination of the contract period, addressed to the Contractor at the address set forth in the Contract for receipt of orders, or in the Contract Award Notification.

All Purchase Orders issued pursuant to contracts let by the Purchasing Agent must bear the appropriate contract number and, if necessary, required State approvals. Unless otherwise specified, all Purchase Orders against centralized contracts will be placed by Authorized Users directly with the Contractor and any discrepancy between the terms stated on the vendors order form, confirmation or acknowledgment, and the contract terms shall be resolved in favor of the terms most favorable to the Authorized User.

If, with respect to an agency specific contract, a Purchase Order is not received within two weeks after the issuance of a Contract Award Notification, it is the responsibility of the Contractor to request in writing that the appropriate Authorized User forward a Purchase Order. If, thereafter, a Purchase Order is not received within a reasonable period of time, the Contractor shall promptly notify the appropriate purchasing officer in Essex County. Failure to timely notify such officer may, in the discretion of the Purchasing Agent and without cost to the State, result in the canceling of such requirement by the Purchasing Agent with, at the Purchasing Agents discretion, a corresponding reduction in the contract quantity and price.

45. PRODUCT DELIVERY It shall be understood that with respect to contract deliveries, time is of the essence. Delivery must be made as ordered and in accordance with the terms of the contract. Unless otherwise specified in the Bid Specifications, delivery shall be made within thirty calendar days after receipt of a purchase order by the Contractor. The decision of the Purchasing Agent as to compliance with delivery terms shall be final. The burden of proof for delay in receipt of Purchase Order shall rest with the Contractor. In all instances of a potential or actual delay in delivery, the Contractor shall immediately notify the Purchasing Agent and the Authorized User, and confirm in writing the explanation of the delay, and take appropriate action to avoid any subsequent late deliveries. Any extension of the time for delivery must be requested in writing by the Contractor and approved in writing by the Purchasing Agent. Failure to meet such time schedule may be grounds for cancellation of the order or, in the Purchasing Agents discretion, the Contract.

The County must be notified twenty-four (24) hours in advance of delivery. The County reserves the right to deny acceptance of delivery if this notice is not given, at no cost to the County.

The successful bidder shall be responsible for delivery of items in good condition at point of destination, and shall file with the carrier all claims for breakage, imperfections, and other losses, which will be deducted from invoices. The Purchasing Agent will note for the benefit of successful bidder when packages are not received in good condition. Carton shall be labeled with purchase order or contract number, successful bidders name and general statement of contents. Failure to comply with this condition shall be considered sufficient reason for refusal to accept the goods.

Unless otherwise stated in the specifications, all items must be delivered into and placed at a point within the building as directed by the shipping instructions or the Purchasing Agent. The successful bidder will be required to furnish proof of delivery in every instance.

Unloading and placing of equipment and furniture is the responsibility of the successful bidder, and the County accepts no responsibility for unloading and placing of equipment. Any costs incurred due to the failure of the successful bidder to comply with this requirement will be charged to him. No help for unloading will be provided by the County, and suppliers should notify their truckers accordingly.

All deliveries shall be accompanied by delivery tickets or packing slips. Ticket shall contain the following information for each item delivered:

Contract Number and/or Purchase Order Number
Name of Article
Item Number (if applicable)
Quantity
Name of the Successful Bidder

46. SATURDAY & HOLIDAY DELIVERIES Unless otherwise specified in the Bid Specifications or by an Authorized User, deliveries will not be scheduled for Saturdays, Sundays or legal holidays observed by the State of New York except of Product for daily consumption or where an emergency exists or the delivery is a replacement or is late, in which event the convenience of the Authorized User shall govern.

47. SHIPPING / RECEIPT OF PRODUCT

(a) Packaging Tangible Product shall be securely and properly packed for shipment, storage and stocking in appropriate, clearly labeled shipping containers and according to accepted commercial practice, without extra charge for packing materials, cases or other types of containers. The container shall become and remain the property of the receiving entity unless otherwise specified in the contract documents.

(b) Shipping Charges Contractor shall be responsible for insuring that the Bill of Lading states "charges prepaid" for all shipments. Unless otherwise stated in the Bid Specifications, all deliveries shall be deemed to be FOB Destination tailgate delivery at the dock of the Authorized User. Unless otherwise agreed, items purchased at a price F.O.B. Shipping point plus transportation charges are understood to not relieve the contractor from responsibility for safe and proper delivery notwithstanding the Authorized Users payment of transportation charges.

(c) Receipt of Product The Contractor shall be solely responsible for assuring that deliveries are made to personnel authorized to accept delivery on behalf of the Authorized User. Any losses resulting from the Contractors failure to deliver Product to authorized personnel shall be borne exclusively by the Contractor.

48. TITLE AND RISK OF LOSS Notwithstanding the form of shipment, title and risk of loss shall not pass from the Contractor to the Authorized User until the Products have been received, inspected and accepted by the receiving entity. Acceptance shall occur within a reasonable time or in accordance with such other defined acceptance period as may be specified in the Bid Specifications. Mere acknowledgment by Authorized User personnel of the delivery or receipt of goods (e.g. signed bill of lading) shall not be deemed or construed as acceptance of the Products received. Any delivery of Product which is substandard or does not comply with the Contract terms, may be rejected or accepted on an adjusted price basis, as determined by the Purchasing Agent.

49. RE-WEIGHING PRODUCT Deliveries are subject to re-weighing at the point of destination by the receiving entity. If shrinkage occurs which exceeds that normally allowable in the trade, the receiving

entity shall have the option to require delivery of the difference in quantity, or to reduce the payment accordingly.

50. PRODUCT SUBSTITUTION In the event a specified manufacturers Product listed in the Contractors Bid becomes unavailable or cannot be supplied by the Contractor for any reason (except as provided for in the Force Majeure Clause below) a Product deemed by the Purchasing Agent to be the equal or better of the specified commodity or service must be substituted by the Contractor at no additional cost or expense to the Authorized User. Unless otherwise specified, any substitution of Product prior to the Purchasing Agents approval may be cause for cancellation of contract.

51. REJECTED PRODUCT When Products are rejected, they must be removed by the Contractor from the premises of the receiving entity within ten days of notification of rejection by Authorized User. Upon rejection notification, risk of loss of rejected or non-conforming Product shall remain on Contractor. Rejected items not removed by the Contractor within ten days of notification shall be regarded as abandoned by the Contractor, and the Authorized User shall have the right to dispose of the items as its own property. The Contractor shall promptly reimburse the Authorized User for any and all costs and expenses incurred in storage or effecting removal or disposition.

52. INSTALLATION Where installation is required, Bidder shall be responsible for placing and installing the equipment in the required locations. All materials used in the installation shall be of good quality and shall be free from any and all defects which would mar the appearance of the equipment or render it structurally unsound. Installation includes the furnishing of any equipment, rigging and materials required to install or replace the Product in the proper location. The Contractor shall protect the site from damage for all its work and shall repair damages or injury of any kind caused by the Contractor, its employees, officers or agents. If any alteration, dismantling or excavation, etc. is required to effect installation, the Contractor shall thereafter promptly restore the structure or site to its original condition. Work shall be performed so as to cause the least inconvenience to the Authorized User(s) and with proper consideration for the rights of other contractors or workers. The Contractor shall promptly perform its work and shall coordinate its activities with those of other contractors. The Contractor shall clean up and remove all debris and rubbish from its work as required or directed. Upon completion of the work, the building and surrounding area of work shall be left clean and in a neat, unobstructed condition, and everything in satisfactory repair and order.

53. REPAIRED OR REPLACED PRODUCT / COMPONENTS Where the Contractor is required to repair, replace or substitute Product or components under the Contract, the repaired, replaced or substituted Product shall be subject to all terms and conditions for new Product set forth in the contract, including product warranties.

54. ON-SITE STORAGE Materials, equipment or supplies may be stored at the County/s or Authorized User's site at the Contractors sole risk and only with the approval of, as the case may be, the County or the Authorized User.

55. EMPLOYEES / SUBCONTRACTORS / AGENTS All employees, subcontractors or agents performing work under the contract must be trained technicians who meet or exceed the technical and training qualifications set forth in the Bid Specifications or the Bid, whichever is greater, and must comply with all rules and requirements of the Contract. The Purchasing Agent reserves the right to conduct a security background check or otherwise approve any employee or agent furnished by Contractor and to refuse access to or require replacement of any personnel for cause, including but not limited to, technical or training qualifications, quality of work or change in security status or non-compliance with Authorized Users security or other requirements. Such approval shall not relieve the Contractor of the obligation to perform all work in compliance with the contract terms. The Purchasing Agent reserves the right to reject and/or bar from the facility for cause any employee, subcontractor, or agents of the Contractor.

56. ASSIGNMENT / SUBCONTRACTORS The Contractor shall not assign, transfer, convey, sublet, or otherwise dispose of the contract or its right, title or interest therein, or its power to execute such contract to any other person, company, firm or corporation in performance of the contract, other than the assignment of the right to receive moneys due, without the prior written consent of Essex County. Prior to an assignment of the right to receive moneys becoming effective, Contractor shall file a written notice of such assignment simultaneously with Essex County and participating Authorized User(s).

The Purchasing Agent reserves the right to reject any proposed subcontractor, assignee or supplier for bona fide business reasons, which may include, but are not limited to: that the proposed transferee is on the Department of Labors list of companies with which New York State cannot do business; the Purchasing Agent determines that the company is not qualified; unsatisfactory contract performance or service has been previously provided; or attempts were not made to solicit minority and womens business enterprises (M/WBE) bidders for the subcontract.

57. PERFORMANCE / BID BOND Essex County reserves the right to require the Bidder/Contractor to furnish without additional cost, a performance, payment or bid bond or negotiable irrevocable letter of credit or other form of security for the faithful performance of the contract, whenever the Purchasing Agent in his/her sole discretion deems such bond or security to be in Essex County's best interest. Where required, such bond or other security shall be in the form prescribed by the Purchasing Agent.

58. STOP / SUSPENSION OF WORK

(a) Stop Work Order The Purchasing Agent reserves the right to stop the work covered by this contract at any time that the successful Contractor becomes unable or incapable of performing the work or meeting any requirements or qualifications set forth in the contract. In the event of such stopping, the Purchasing Agent shall have the right to arrange for the completion of the work in such manner as it may deem advisable and if the cost thereof exceeds the amount of the bid, the successful Contractor shall be liable for any such cost on account thereof.

(b) Suspension of Work Order The Purchasing Agent, in his/her sole discretion, reserves the right to suspend any or all activities under this contract, at anytime, in the best interests of the State or Issuing Entity. In the event of such suspension, the contractor will be given a formal written notice outlining the particulars of such suspension. Examples of the reason for such suspension include, but are not limited to, a budget freeze on County spending, declaration of emergency, or other such circumstances. Upon issuance of such suspension of work, the Contractor is not to accept any purchase orders, as specified in the Suspension Order. Activity may resume at such time as the Purchasing Agent issues a formal written notice authorizing a resumption of work.

59. CANCELLATION A contract may be canceled by the Purchasing Agent, and/or an Authorized User may cancel its participation, license or service order under the contract, at the Contractors expense upon non-performance, or upon a determination that Contractor is non-responsive, or non-responsible.

60. FORCE MAJEURE The Contractor shall not be responsible for delay resulting from its failure to perform if neither the fault nor negligence of the Contractor, its officers, employees or agents contributed to such delay and the delay is due directly to acts of God, wars, acts of public enemies, strikes, fires or floods, or other similar cause beyond the control of the Contractor, or for any of the foregoing which affect subcontractors or suppliers and no alternate source of supply is available to the Contractor. In such event, Contractor shall notify the Purchasing Agent, by certified or registered mail, of the delay or potential delay and the cause(s) thereof either (a) within ten (10) calendar days after the cause which creates or will create the delay first arose if the Contractor could reasonably foresee that a delay could occur by reason thereof, or (b), if delay is not reasonably foreseeable, within five (5) calendar days after the date the Contractor first had reason to believe a delay could result. The foregoing shall constitute the Contractors sole remedy or excuse with respect to such delay. In the

event performance is suspended or delayed, in whole or in part, by reason of any of the aforesaid causes or occurrences and proper notification is given the Purchasing Agent, any performance so suspended or delayed shall be performed by the Contractor at no increased cost, promptly after such disabilities have ceased to exist unless it is determined in the sole discretion of the Purchasing Agent that the delay will significantly impair the value of the contract to the County or to Authorized Users, whereupon the Purchasing Agent may:

- (a) Accept allocated performance or deliveries from the Contractor. The Contractor, however, hereby agrees to grant preferential treatment to County Agencies with respect to Product subjected to allocation; and/or
- (b) Purchase from other sources (without recourse to and by the Contractor for the costs and expenses thereof) to replace all or part of the Products which are the subject of the delay, which purchases may be deducted from the contract quantity; or
- (c) Terminate the contract or the portion thereof which is subject to delivery delays, and thereby discharge any unexecuted portion of the contract or the relative part thereof.

61. CONTRACT BILLINGS Contractor shall provide complete and accurate billing invoices to each Authorized User in order to receive payment. Billings for Agencies must contain all information required by the County Treasurer and/or Auditor. The County Treasurer shall render payment for Agency purchases, and such payment shall be made in accordance with ordinary County procedures and practices. Payment of contract purchases made by Authorized Users other than Agencies shall be billed directly by Contractor on invoices/vouchers, together with complete and accurate supporting documentation as required by the Authorized User.

Submission of an invoice and payment thereof shall not preclude the Purchasing Agent from reimbursement or demanding a price adjustment in any case where the Product delivered is found to deviate from the terms and conditions of the bid and award documents.

62. DEFAULT - AUTHORIZED USER An Authorized Users breach shall not be deemed a breach of the centralized contract. In the event a participating Authorized User fails to make payment to the Contractor for Products delivered, accepted and properly invoiced, within 60 days of such delivery and acceptance, the Contractor may, upon 10 days advance written notice to both the Purchasing Agent and the Authorized Users purchasing official, suspend additional shipments of Product or provision of services to such entity until such time as reasonable arrangements have been made and assurances given by such entity for current and future contract payments.

Notwithstanding the foregoing, the Contractor shall, at least 10 days prior to declaring a breach of contract by any Authorized User, by certified or registered mail, notify both the Purchasing Agent and the purchasing official of the breaching Authorized User of the specific facts, circumstances and grounds upon which a breach will be declared. It is understood, however, that if the Contractors basis for declaring a breach is insufficient, the Contractors declaration of breach and failure to service an Authorized User shall constitute a breach of its contract and the County or Authorized User may thereafter utilize any remedy available at law or equity.

63. INTEREST ON LATE PAYMENTS

- (a) **County Agencies** The payment of interest on certain payments due and owed by a County agency may be made in accordance with Section 3-a of the *General Municipal Law* at the rate of three percent (3%) per annum.
- (b) **By Non-County Agencies** The terms of Article 11-A apply only to procurements by and the consequent payment obligations of the County. Neither expressly nor by any implication is the County responsible for payments on any purchases made by a Non-County Agency

Authorized User.

(c) By Contractor Should the Contractor be liable for any payments to the County hereunder, interest, late payment charges and collection fee charges will be determined and assessed pursuant to Section 18 of the *State Finance Law* to the same extent as though the contract was with the State of New York rather than the County.

64. REMEDIES FOR BREACH It is understood and agreed that all rights and remedies afforded below shall be in addition to all remedies or actions otherwise authorized or permitted by law:

(a) Cover / Substitute Performance Upon the failure of the Contractor to properly perform within the time specified, failure to provide acceptable service, to make immediate replacement of rejected Product when so requested, or upon the revocation of the Contract by the Purchasing Agent for cause, or upon repudiation of the contract by the Contractor, the Purchasing Agent may, with or without formally bidding same:

i. Purchase from other sources to replace the Product rejected, revoked, not timely delivered or repudiated; or

ii. If after making reasonable attempts, under the circumstances then existing, to timely provide acceptable service or acquire replacement product of equal or comparable quality, the Purchasing Agent is unsuccessful, the Purchasing Agent may acquire acceptable service or replacement product of lesser or greater quality.

Such purchases may, in the discretion of the Purchasing Agent, be deducted from the contract quantity.

(b) Withhold Payment In any case where a question of non-performance by Contractor arises, payment may be withheld in whole or in part at the discretion of the Purchasing Agent. Should the amount withheld be finally paid, a cash discount originally offered may be taken as if no delay in payment had occurred.

(c) Reimbursement of Costs Incurred The Contractor agrees to reimburse the County and/or Authorized User promptly for any and all additional costs and expenses incurred for acquiring acceptable services, and/or replacement Product. Should the cost of cover be less than the contract price, the Contractor shall have no claim to the difference. The Contractor covenants and agrees that in the event suit is successfully prosecuted for any default on the part of the Contractor, all costs and expenses expended or incurred by the County or Authorized User in connection therewith, including reasonable attorneys fees, shall be paid by the Contractor.

Where the Contractor fails to timely deliver pursuant to the guaranteed delivery terms of the contract, the Purchasing Agent may authorize an ordering Authorized User to rent substitute equipment temporarily. Any sums expended for such rental shall, upon demand, be reimbursed to the Authorized User promptly by the Contractor or deducted by the Authorized User from payments due or to become due the Contractor on the same or another transaction.

(d) Deduction / Credit Sums due as a result of these remedies may be deducted or offset by the County or Authorized User from payments due, or to become due, the Contractor on the same or another transaction. If no deduction or only a partial deduction is made in such fashion the Contractor shall pay to the County or Authorized User the amount of such claim or portion of the claim still outstanding, on demand. The Purchasing Agent reserves the right to determine the disposition of any rebates, settlements, restitution, liquidated damages, etc. which arise from the administration of the contract.

65. ASSIGNMENT OF CLAIM Contractor hereby assigns to the County any and all its claims for overcharges associated with this contract which may arise under the antitrust laws of the United States, 15 U.S.C. Section 1, *et seq.* and the antitrust laws of the State of New York, *General Business Law* Section 340, *et seq.*

66. TOXIC SUBSTANCES Each Contractor furnishing a toxic substance as defined by Section 875 of the *Labor Law*, shall provide such Authorized User with not less than two copies of a material safety data sheet, which sheet shall include for each such substance the information outlined in Section 876 of the *Labor Law*.

Before any chemical product is used or applied on or in any building, a copy of the product label and Material Safety Data Sheet must be provided to and approved by the user agency representative.

67. INDEPENDENT CONTRACTOR It is understood and agreed that the legal status of the Contractor, its agents, officers and employees under this Contract is that of an independent contractor, and in no manner shall they be deemed employees of the County or Authorized User, and therefore are not entitled to any of the benefits associated with such employment. The Contractor agrees, during the term of this contract, to maintain at Contractors expense those benefits to which its employees would otherwise be entitled by law, including health benefits, and all necessary insurance for its employees, including workers compensation, disability and unemployment insurance, and to provide the Authorized User with certification of such insurance upon request. The Contractor remains responsible for all applicable federal, state and local taxes, and all FICA contributions.

68. SECURITY / CONFIDENTIALITY Contractor warrants, covenants and represents that it will comply fully with all security procedures of the County and any Authorized User(s) in performance of the Contract.

Contractor further warrants, covenants and represents that any confidential information obtained by Contractor, its agents, subcontractors, officers, or employees in the course of performing its obligations, including without limitation, security procedures, business operations information, or commercial proprietary information in the possession of the County or any Authorized User hereunder or received from another third party, will not be divulged to any third parties. Contractor shall not be required to keep confidential any such confidential material which is publicly available through no fault of Contractor, independently developed by Contractor without reliance on confidential information of the County or Authorized User, or otherwise obtained under the Freedom of Information Act or other applicable New York State Laws and Regulations. This warranty shall survive termination of this Contract for a period of five (5) years. Contractor further agrees to take appropriate steps to instruct its personnel, agents, officers and any subcontractors regarding the obligations arising under this clause to insure such confidentiality.

69. COOPERATION WITH THIRD PARTIES The Contractor shall be responsible for fully cooperating with any third party agents, including but not limited to subcontractors of the Authorized User, relating to delivery of product or coordination of services.

70. CONTRACT TERM - EXTENSION In addition to any stated renewal periods in the Contract, any contract or unit portion thereof let by the Purchasing Agent may be extended by the Purchasing Agent for an additional period(s) of up to one year (cumulatively) with the written concurrence of the Contractor.

71. WARRANTIES & GUARANTEES Contractor hereby warrants and guarantees:

- (a) To fully defend, indemnify and save harmless the County, Authorized Users and their respective officers, agents and employees from suits, actions, damages and costs of every name and description arising out of the acts or omissions of Contractor, its officers, employees,

subcontractors, partners, or agents, in any performance under this contract including: i) personal injury, damage to real or personal tangible or intangible property, without limitation; ii) negligence, either active or passive, without limitation, or iii) infringement of any law or of a United States Letter Patent with respect to the Products furnished, or of any copyright, trademark, trade secret or other third party intellectual proprietary rights, without limitation, provided that the County or Authorized User shall give Contractor: (a) prompt written notice of any action, claim or threat of infringement suit, or other suit, promptness of which shall be established by Authorized User upon the furnishing of written notice and verified receipt, (b) the opportunity to take over, settle or defend such action, claim or suit at Bidders sole expense, and (c) assistance in the defense of any such action at the expense of Contractor. Where a dispute or claim arises relative to a real or anticipated infringement, the County or Authorized User may require Bidder/Contractor, at its sole expense, to submit such information and documentation, including formal patent attorney opinions, as the Purchasing Agent shall require.

(b) Contractor warrants full ownership, clear title free of all liens, or perpetual license rights to any Products transferred to Authorized User under this Contract, and Contractor shall be solely liable for any costs of acquisition associated therewith without limitation. Contractor warrants that Authorized User will have undisturbed, peaceful use of the Products, including, without limitation, software, object or source codes, custom programming or third party intellectual property rights incorporated or embedded therein, and training modules or Documentation. Contractor fully indemnifies the County and Authorized User for any loss, damages or actions arising from a breach of said warranty without limitation.

(c) To pay, at its sole expense, all applicable permits, licenses, tariffs, tolls and fees and give all notices and comply with all laws, ordinances, rules and regulations of any governmental entity in conjunction with the performance of obligations under the contract.

(d) Unless recycled or recovered materials are available in accordance with the "Recycled & Recovered Materials" clause, Product offered shall be standard new equipment, current model of regular stock product with all parts regularly used with the type of equipment offered; and no attachment or part has been substituted or applied contrary to the manufacturers recommendations and standard practice. Every Product, including any substituted or replacement unit delivered, must be guaranteed against faulty material and workmanship for a period of one year from and after the date the unit is accepted unless otherwise specified by the County or Authorized User. Notwithstanding the foregoing, when the manufacturers standard guarantee for Product or any component thereof exceeds one year, the longer guarantee period shall apply to such unit or component thereof delivered under this contract. Furthermore, the Contractor agrees to extend its warranty period with regard to any Product delivered by the cumulative periods of time, after notification, during which the Product requires servicing or replacement (down time) or is in the possession of the Contractor, its agents, officers or employees. If during the regular or extended warranty periods faults develop, the Contractor shall promptly repair or, upon demand, replace the defective unit or component part affected. All costs for labor and material and transportation incurred to repair or replace defective goods during the warranty periods shall be borne solely by the Contractor, and the County or Authorized User shall in no event be liable or responsible therefore. This warranty shall survive any termination of the contract in accordance with the warranty term.

(e) Where the provision of services requires the replacement or repair of Product, any replaced or repaired component, part or Product shall be new and shall, if available, be replaced by the original manufacturers component, part or Product. All proposed substitutes for the original manufacturers installed Product must be approved by the Authorized User before installation. The Product or part shall be equal to or of better quality than the original Product being replaced. Any Product replaced by the Contractor under the contract shall be guaranteed for one (1) year from the date of replacement and replaced at no cost to the Authorized User if found defective during that time.

(f) Prior to award and during the Contract term and any renewals thereof, Contractor must establish to the satisfaction of the Purchasing Agent that it meets or exceeds all requirements of the bid and any applicable laws, including but not limited to, permits, insurance coverage, licensing, proof of coverage for workman's compensation, and shall provide such proof as required by the Purchasing Agent. Failure to do so may constitute grounds for the County to cancel or suspend this contract, in whole or in part, or to take any other action deemed necessary by the Purchasing Agent.

The Contractor further warrants and guarantees:

i. His/Her/Its products against defective material or workmanship and to repair or replace any damages or marring occasioned in transit.

ii. To furnish adequate protection from damage for all work and repair damages of any kind for which he or his workmen are responsible, to the building or equipment, to his own work, or to the work of other successful bidders.

iii. To carry adequate insurance to protect the County from loss in case of accident, fire, theft, etc.

iv. That all deliveries will be equal to the accepted bid sample.

v. That the equipment delivered is standard, new, latest model of regular stock product or as required by the specifications; also that no attachment or part has been substituted or applied contrary to manufacturer's recommendations and standard practice. Every unit delivered must be guaranteed against faulty material and workmanship for a period of at least one year from date of delivery. If during this period such faults develop, the successful bidder agrees to replace the unit or the part affected without cost to the County. Any merchandise provided under the contract which is or becomes defective during the guarantee period shall be replaced by the successful bidder free of charge with the specific understanding that all replacements shall carry the same guarantee as the original equipment. The successful bidder shall make any such replacement immediately upon receiving notice from the County.

vi. That all manufacturers product warranties and guarantees shall be furnished to the County, and that the County's rights thereunder shall not be in any way impaired or limited.

GENERAL

72. APPLICABILITY In addition to the terms contained in **Part I (General - All Procurements)**, the terms contained in **Part II (Software & Technology Procurements)** apply to software and technology procurements.

73. DEFINITIONS - Part II

DOCUMENTATION The complete set of manuals (e.g. user, installation, instruction or diagnostic manuals) in either hard or electronic copy, necessary to enable an Authorized User to properly test, install, operate and enjoy full use of the Product in accordance with the license rights.

ENTERPRISE The business operations in the United States of a Licensee or Enterprise Participant, without regard to geographic location where such operations are performed or the entity actually performing such operations on behalf of Licensee or Enterprise Participant. For the County of New York, "business operations" shall be defined as the business operations of all Agencies, as defined in Part I.

ENTERPRISE LICENSE A contract which grants Enterprise Participants unlimited license rights to access, use and/or execute Product within the Enterprise.

ENTERPRISE PARTICIPANTS One or more Licensees, as defined in Part I, participating in an Enterprise License.

LICENSE EFFECTIVE DATE The date Product is delivered to an Authorized User. Where a License involves Licensees right to copy a previously licensed and delivered Master Copy of a Program, the license effective date for additional copies shall be deemed to be the date on which the Purchase Order is executed.

LOGICAL PARTITION A subset of the processing power within a CEC which has been divided through hardware and/or software means (i.e. *Processor Resources/System Manager [PR/SM]*) so as to limit the total processing power which is accessible by an operating system image by individual users or individual software products.

OBJECT CODE The machine executable code that can be directly executed by a computers central processing unit(s).

PHYSICAL PARTITION A subset of the processing power within a CEC which has been derived through hardware means so as to limit the total processing power accessible by an operating system image by individual users or individual Products.

SITE The location (street address) where Product will be executed.

SOURCE CODE The programming statements or instructions written and expressed in any language understandable by a human being skilled in the art which are translated by a language compiler to produce executable machine Object Code.

TERMS OF LICENSE The terms and conditions set forth in the Contract which are in effect and applicable to a Product order at the time of order placement, and only such additional terms as are consistent therewith or more advantageous to the Authorized User as are set forth on the individual Product order form executed and approved by both Authorized User and Contractor.

VIRUS Any computer code, whether or not written or conceived by Contractor, which disrupts, disables, harms, or otherwise impedes in any manner the operation of the Product, or any other associated software, firmware, hardware, or computer system (such as local area or wide-area networks), including aesthetic disruptions or distortions, but does not include security keys or other such devices installed by Product manufacturer.

TERMS AND CONDITIONS

74. SOFTWARE LICENSE GRANT *Unless otherwise set forth in the Bid Specifications or Contract, where Product is acquired on a licensed based the following shall constitute the license grant:*

(a) **License Scope** Licensee is granted a non-exclusive, perpetual license to use, execute, reproduce, display, perform, or merge the Product with other product within its business enterprise in the United States. Licensee shall have the right to use and distribute modifications or customizations of the Product to and for use by any Authorized Users otherwise licensed to use the product, provided that any modifications, however extensive, shall not diminish manufacturers proprietary title or interest. No license, right or interest in any trademark, trade name, or service mark is granted hereunder.

(b) **License Term** The license term shall commence upon the License Effective Date. Where the terms of license permit licensing on a non-perpetual basis, the license term stated in

the Contract shall be extended by the time periods allowed for testing and acceptance.

(c) Licensed Documentation Contractor hereby grants to Licensee a perpetual license right to make, reproduce (including downloading electronic copies of the Product) and distribute, either electronically or otherwise, copies of Product Documentation as necessary to enjoy full use of the Product. If commercially available, Licensee shall have the option to require the Contractor to deliver, at Contractors expense: a) One (1) hard copy and One (1) Master Electronic Copy of the Documentation in diskette or CD-ROM format; or b) hard copies of the Product Documentation by type of license in the following amounts, unless otherwise mutually agreed:

- Individual/Named User License – 1 copy per License
- Concurrent Users – 8 copies per site
- Processing Capacity – 8 copies per site

(d) Product Use Product may be accessed, used, executed, reproduced, displayed, performed by Licensee to service all Authorized Users of the machine on which Product is installed, up to the capacity measured by the applicable licensing unit stated in the terms of license (i.e. payroll size, number of employees, CPU, MIPS, MSU, concurrent user, workstation).

(e) Permitted License Transfers As Licensee's business operations may be altered, expanded or diminished, licenses granted hereunder may be transferred or combined for use at an alternative or consolidated Authorized User site not originally specified in the license, including transfers between Agencies ("permitted license transfers"). Licensee(s) do not have to obtain the approval of Contractor for permitted license transfers, but must give thirty (30) days prior written notice to Contractor of such move(s) and certify in writing that the Product is not in use at the prior site. There shall be no additional license or other transfer fees due Contractor, provided that: i) the maximum capacity of the consolidated machine is equal to the combined individual license capacity of all licenses running at the consolidated or transferred site. (e.g., named users, seats, or MIPS); and ii) that, if the maximum capacity of the consolidated machine is greater than the individual license capacity being transferred, a logical or physical partition or other means of restricting access will be maintained within the computer system so as to restrict use and access to the Product to that unit of licensed capacity solely dedicated to beneficial use for Licensee.

(f) Restricted Use By Outsourcers / Facilities Management, Service Bureaus / or Other Third Parties Outsourcers, facilities management or service bureaus retained by Licensee shall have the right to use the Product to maintain Licensee's business operations, including data processing, for the time period that they are engaged in such activities, provided that: 1) Licensee gives notice to Contractor of such party, site of intended use of the Product, and means of access; and 2) such party has executed, or agrees to execute, the Product manufacturers standard nondisclosure or restricted use agreement which executed agreement shall be accepted by the Contractor ("NonDisclosure Agreement"); and 3) if such party is engaged in the business of facility management, outsourcing, service bureau or other services, such third party will maintain a logical or physical partition within its computer system so as to restrict use and access to the program to that portion solely dedicated to beneficial use for Licensee. In no event shall Licensee assume any liability for third partys compliance with the terms of the Non-Disclosure Agreement, nor shall the Non-Disclosure Agreement create or impose any liabilities on the County or Licensee.

Any third party with whom a Licensee has a relationship for a state function or business operation, shall have the temporary right to use Product (using, for example, but not limited to, JAVA Applets), provided that such use shall be limited to the time period during which the third party is using the Product for the stated function or business activity.

(g) Archival Back-Up and Disaster Recovery Licensee may use and copy the Product and related Documentation in connection with: 1) reproducing a reasonable number of copies of the Product for archival backup and disaster recovery procedures in the event of destruction or corruption of the Product or disasters or emergencies which require Licensee to restore backup(s) or to initiate disaster recovery procedures for its platform or operating systems; 2) reproducing a reasonable number of copies of the Product and related documentation for cold site storage. "Cold Site" storage shall be defined as a restorable back-up copy of the Product not to be installed until and after the declaration by the Licensee of a disaster; 3) reproducing a back-up copy of the Product to run for a reasonable period of time in conjunction with a documented consolidation or transfer otherwise allowed under paragraph (F) above. "Disaster Recovery" shall be defined as the installation and storage of Product in ready-to-execute, back-up computer systems prior to disaster or breakdown which is not used for active production or development.

(h) Confidentiality Restrictions The Product is a trade secret and proprietary product. Licensee and its employees will keep the Product strictly confidential, and Licensee will not disclose or otherwise distribute or reproduce any Product to anyone other than as authorized under the terms of license. Licensee will not remove or destroy any proprietary markings of Contractor.

(i) Restricted Use by Licensee Except as expressly authorized by the terms of license, Licensee shall not:

- a. Copy the Product;
- b. Cause or permit reverse compilation or reverse assembly of all or any portion of the Product;
- c. Distribute, disclose, market, rent, lease or transfer to any third party any portion of the Product or the Documentation, or use the Product or Documentation in any service bureau arrangement;
- d. Disclose the results of Product performance benchmarks to any third party who is not an Authorized User without prior notice to Contractor;
- e. Export the Licensed Software in violation of any U.S. Department of Commerce export administration regulations.

75. ENTERPRISE LICENSE OPTION FOR SOFTWARE Multiple Authorized Users may license any Product offered under the Contract on behalf of their collective business operations. An Enterprise License shall incorporate the terms set forth in this Part II and the pricing set forth in the Contract, and additionally the following terms:

(a) Enterprise – Defined Any Authorized User may be an Enterprise Participant. Enterprise Participants will be enumerated in the Enterprise License, including: i) contact name, ship to and main billing address of each Enterprise Participant, ii) street address of the included End User sites of each Enterprise Participant. The originally defined Enterprise may be modified at any time thereafter, including deletion or addition of Enterprise Participants, sites ownership to" locations, provided that Contractor is given written notice and that any additional capacity required by such addition is licensed in accordance with the Enterprise License terms.

(b) Product Use Product licensed under this Enterprise Option shall be licensed with the rights set forth in this Part II, without reference to a specific designated system or Licensee, up to the maximum licensed capacity. Product may be used and freely transferable anywhere

within the defined Enterprise, including higher or lower performance machines, and Enterprise Participants will not incur an increase in license, support or other charges provided that the aggregate utilization of the Product does not exceed the aggregate Enterprise Licensed capacity.

(c) Submission of Orders, Billing and Usage Reporting An Enterprise may be established for order placement and billing as either a “single” or “multiple” point of contact, at Licensees option. Where designated as a “single”, one Enterprise Participant shall be designated as the lead agency and central point for submission of Purchase Orders, usage reporting and billing. Where designated as “multiple” point of contact, each designated Enterprise Participant shall be responsible for submission of Purchase Orders, reporting and billing with regard to its use of Enterprise Licensed Product. For either single or multiple point of contact Enterprises, a) Contractor agrees to hold each Enterprise Participant solely responsible for payment and performance; and b) Contractor shall be responsible for furnishing an annual report to each designated point of contact summarizing overall Enterprise License activity for the preceding twelve months.

(d) Shipping / Delivery Contractor shall be responsible for delivery of Master Copies of Enterprise Licensed Product and documentation to Enterprise Participants. Within either “Single” or “Multiple” Enterprise Licenses, shipping and delivery of Master Copies of Product and Documentation shall be the responsibility of Contractor to each “ship to” location specified on the Purchase Order(s). Distribution and installation of Enterprise Licensed Product to End Users at a site shall be the responsibility of the Licensee.

(e) Enterprise Operating Systems Unless otherwise specified by the parties, up to ten (10) hardware/operating system combinations for Product shall be included at no additional charge. The initial ten hardware/operating systems may be specified at any time within five (5) years of the Enterprise License effective date. Additional hardware/operating systems beyond the initial ten (10) may be specified at anytime by the Enterprise, however if additional copies of Product are required for hardware/operating systems beyond the initial ten, the cost for such systems will be as mutually agreed between the parties.

(f) Product Acceptance Each Enterprise Participant shall have a right of acceptance, as set forth above in this Part II, only for the first copy of Product for its site(s).

(g) Enterprise Fees Enterprise License Fees shall be set forth in the Contract. Notwithstanding the foregoing, the Product license fees for additional copies or units of capacity for Enterprise licensed Product shall not increase by more than six percent (6%) annually each year during the Enterprise License term. Contractor may offer additional discounts/incentives for Enterprise Participants as may be mutually agreed between the parties. Enterprise Participants shall be entitled to aggregate the volume of all Enterprise Participants for purposes of establishing any applicable discounts under the Contract, and Enterprise Licensed Volume shall be aggregated with volume of non-Enterprise Licensed Product otherwise purchased under the centralized Contract. Upon termination of the Enterprise, Enterprise Participants have the right to acquire additional capacity or users at the Enterprise License price for twelve months after the termination of the Enterprise License.

(h) Technical Support Unless otherwise mutually agreed, technical support is optional and may be elected individually by Product by each Enterprise Participant. Where an Enterprise Participant is under a current maintenance or technical support contract, such Enterprise Participant shall be entitled to credit any support paid covering any portion of the Enterprise License Term to the fees due under the Enterprise license.

Enterprise Participants shall have the right to partially or wholly de-support a subset of unused Enterprise licensed capacity upon written notice to Contractor at the end of any then -

current technical support term without penalty or charge. The capacity for a Program license which has been de-supported must remain inactive and may not be used within the Enterprise unless technical support for such capacity has been reinstated. In the event of de-support, Contractor reserves the right to reasonably determine compatibility of future releases or new programs prior to shipment.

(i) Merger of Two or More Enterprises Two or more Enterprises may be merged to form a larger Enterprise for the purpose of sharing and exchanging data at no additional license fee provided that participants give Contractor notice of such merger and that the combined capacity does not exceed the maximum capacity of the individual licenses.

(j) "Nested" Enterprises Individual Enterprise License participant(s) may license additional capacity or products for the specific use of a subset of the larger enterprise. Said participant(s) must certify in writing to Contractor that such use is only by the enumerated subset of participants.

(k) Default A default by any Enterprise Participant shall entitle the Contractor to the remedies against such participant under the Contract, but shall not be deemed a default by the remaining non-defaulting Enterprise Participants.

76. PRODUCT ACCEPTANCE Unless otherwise provided in the Bid Specifications, the County and/or Authorized User(s) shall have sixty (60) days from delivery to accept Product. Failure to provide notice of acceptance or rejection by the end of the period provided for under this clause would constitute acceptance by the County or Authorized User(s) as of the expiration of that period.

Unless otherwise provided in the Bid Specifications, The County or Authorized User shall have the option to run acceptance testing on the Product prior to acceptance, such tests and data sets to be specified by User. Where using its own data or tests, The County or Authorized User must have the tests or representative set of data available upon delivery. This demonstration will take the form of a documented installation test, capable of observation by the County or Authorized User, and shall be made part of the Contractors standard documentation. The test data shall remain accessible to the County or Authorized User after completion of the test.

In the event that the documented installation test cannot be completed successfully within sixty (60) days from delivery, and the Contractor or Product is responsible for the delay, The County or Authorized User shall have the option to cancel the order in whole or in part, or to extend the testing period for another sixty (60) day increment. The County or Authorized User shall notify Contractor of acceptance upon successful completion of the documented installation test. Such cancellation shall not give rise to any cause of action against the County or Authorized User for damages, loss of profits, expenses, or other remuneration of any kind.

Costs and liabilities associated with a failure of the Product to perform in accordance with the functionality tests or product specifications during the acceptance period shall be borne fully by Contractor to the extent that said costs or liabilities shall not have been caused by negligent or willful acts or omissions of the The County or Authorized Users agents or employees. Said costs shall be limited to fees paid to Contractor, if any, or any liability for costs incurred at the direction or recommendation of Contractor.

77. AUDIT OF LICENSED PRODUCT USAGE Contractor shall have the right to periodically audit, at its expense, use of licensed Product at any site where a copy of the Product resides provided that: i) Contractor gives Licensee or Enterprise Participants at least thirty (30) days advance notice, ii) such audit is conducted during such party's normal business hours iii) each Licensee or Enterprise Participant is entitled to designate a representative who shall be entitled to participant and simultaneously review all information obtained by the audit, and shall be entitled to copies of all reports, data or information obtained by the Contractor; and iv) if the audit shows that such party is not in

compliance such party shall be liable for the unlicensed capacity and shall be required to purchase the additional units or rights necessary to bring it into compliance.

78. OWNERSHIP / TITLE TO CUSTOM PRODUCTS OR PROGRAMMING Where contract deliverables include custom products or programming, title, rights and interests to such Product(s) shall be determined as follows:

(a) Definitions

Product For purposes of this section, the term “Product” shall have the meaning set forth in Part I of these *General Specifications*, which includes, but is not limited to: software applications or programming, programming tools, documentation (including user or training manuals), modules, interfaces, templates, and other elements such as utilities, subroutines, algorithms, formulas, source code, object code, reports, drawings, or data.

“Existing Product” is defined as any proprietary material(s) existing or developed independently and not at the expense of Licensee.

“Custom Product” is defined as any material(s), exclusive of Existing Product, created, prepared, written, compiled or developed by Contractor, or anyone acting on his behalf for The County or Authorized User pursuant to the Contract.

(b) Contractor or Third Party Manufacturers Title to Existing Product Title to Existing Product(s) does not transfer. With respect to such Existing Product(s), whether embedded in or operating in conjunction with Custom Product, Contractor warrants: a) all right, title and interest in Contractor Existing Product(s); or b) all license rights, title and interest in third party Existing Product(s), which include the right to grant to The County or Authorized User an irrevocable, non-exclusive, worldwide, paid-up license to use, execute, reproduce, display, perform, and distribute Existing Product(s). Contractor hereby grants a irrevocable, non-exclusive, worldwide, paid-up license to use, execute, reproduce, display, perform, and distribute Existing Product(s) embedded in or transferred for use in conjunction with Custom Product(s). The Licensee agrees to reproduce the copyright notice and any other legend of ownership on any copies made under the license granted under this paragraph prior to distribution or use.

(c) Title to Custom Product Title to Custom Product(s), excluding Existing Product, shall be deemed the sole and exclusive property of the County or Authorized User, who shall have all right, title and interest (including ownership and copyrights). For the purposes of the federal copyright law, execution of this contract shall constitute an assignment of all right, title and interest in the Custom Product(s) by Contractor to the County or Authorized User. The County or Authorized User, in its sole discretion, reserves the right to sell Custom Product or to license them on an exclusive or non-exclusive basis to Contractor or other Third Parties. Contractor hereby agrees to take all necessary and appropriate steps to ensure that Custom Product is protected against unauthorized use, execution, reproduction, display, performance, or distribution by or through Contractor, its partners or agents. Notwithstanding this reservation of title, Contractor shall not be precluded from using the related or underlying general knowledge, skills and experience developed in the course of providing the Custom Product in the course of Contractor’s business.

(d) Acquisitions Funded By Tax Exempt Financing In addition to the foregoing rights under a, b and c, the sale or licensing of Custom Product or rights therein shall not occur until such Product or rights are or become useable, and shall be at fair market value which shall be determined at the time of sale or licensing. Any such transfer shall be pursuant to a separate written agreement. If the Contract deliverables are to be funded through tax exempt financing, the County or Authorized User may assign to a Trustee or other entity for security purposes County or Authorized Users ownership and license rights in Custom and Existing Products. Contractor will cooperate with the County or Authorized User to execute such other documents as may be appropriate to achieve the objectives of

this paragraph.

(e) Other Acquisitions (Not Funded by Tax Exempt Financing) In addition to the rights set forth above (paragraphs “a”, “b” and “c”), the County or Authorized User reserves the right to transfer any or all rights to Custom Materials on an exclusive or non-exclusive basis. Where such transfer (sale or licensing) is provided in the Bid Specifications, Contractor shall include a purchase price for such rights in its bid. Such price shall be offered as a deduction from Contractor’s overall Bid or Project Bid price, and shall be weighted as set forth in the bid evaluation criteria, if any. Such rights shall transfer to the successful Bidder/Contractor upon successful completion and acceptance by the County or Authorized User of all contract deliverables. Contractor will cooperate with the County or Authorized User to execute such other documents as may be appropriate to achieve the objectives of this paragraph.

79. PROOF OF LICENSE The Contractor must provide to each Licensee who places a Product order either: a) the Product manufacturer’s certified License Confirmation Certificates in the name of each such Licensee; or b) a written confirmation from the Product manufacturer accepting Contractors Product invoice as proof of license. Bidder or Contractor shall submit a sample manufacturers certificate, or alternatively such written confirmation from the manufacturer, with the Bid or Contract. Such certificates must be in a form acceptable to the Licensee.

80. PRODUCT VERSION Product orders shall be deemed to reference Manufacturers most recently released model or version of the Product at time of delivery, unless an earlier model or version is specifically requested in writing by the County or Authorized User and Contractor is willing to provide such version.

81. MIGRATION TO CENTRALIZED CONTRACT The County or Authorized User may obtain additional Product authorized under this contract, (e.g., licensed capacity upgrades, new releases, documentation, maintenance, consulting or training) whether or not Product was initially obtained independently of this contract. The County or Authorized Users election to obtain additional Product shall not operate to diminish, alter or extinguish rights previously granted.

82. NOTICE OF PRODUCT DISCONTINUANCE In the event that a Product manufacturer proposes to discontinue maintenance or support for Product, Contractor shall (1) notify the County and each Authorized User in writing of the intended discontinuance, and (2) continue to provide maintenance and support for the greater of: a) the best terms offered by Contractor to any other customer, or b) not less than eighteen (18) months from the date of notice, and (3) at The County or Authorized Users option, either a) provided that the County or Authorized User is under maintenance, provide the County or Authorized User with either a Product replacement with equivalent functionality at no additional charge, or b) provide County or Authorized User with the source code for Licensed Product at no additional charge to enable it to continue use and maintenance of the Product.

83. REINSTATEMENT OF MAINTENANCE The County or Authorized User shall not be required to purchase maintenance for use of Product, and may discontinue maintenance at the end of any current maintenance term upon written notice to Contractor. In the event that The County or Authorized User discontinues maintenance of licensed Product, it may, at any time thereafter, reinstate maintenance for Product without any additional penalties or other charges, by paying Contractor at rates which would have been due under the contract for the period of time that such maintenance had lapsed, or for twelve months, whichever is less.

84. NO HARDSTOP / PASSIVE LICENSE MONITORING Contractor hereby represents, warrants and covenants that the Product and all Upgrades do not and will not contain any computer code that would disable the Product or Upgrades or impair in any way its operation based on the elapsing of a period of time, exceeding an authorized number of copies, advancement to a particular date or other numeral, or other similar self-destruct mechanisms (sometimes referred to as “time bombs”, “time locks”, or “drop dead” devices) or that would permit Contractor to access the Product to cause such disablement or

impairment (sometimes referred to as a “trap door” device). Contractor agrees that in the event of a breach or alleged breach of this provision that The County or Authorized User shall not have an adequate remedy at law, including monetary damages, and that The County or Authorized User shall consequently be entitled to seek a temporary restraining order, injunction, or other form of equitable relief against the continuance of such breach, in addition to any and all remedies to which The County or Authorized User shall be entitled.

85. ADDITIONAL WARRANTIES / GUARANTEES Where Contractor or Product manufacturer offers additional or more advantageous warranties than set forth herein, Contractor shall offer or pass through any additional or more advantageous warranties to The County or Authorized Users. In addition to the ‘Warranties/Guarantees’ set forth in Part I, Contractor makes the following warranties.

(a) Product Performance Warranty Contractor represents and warrants that the Products delivered pursuant to this contract conform to the manufacturers specifications, performance standards, and documentation and that the documentation fully describes the proper procedure for using the Products in an efficient manner. Contractor does not warrant that software is error-free.

In the event that Contractor does not remedy a substantial breach of this warranty within the cure period, Licensee shall also have the right to terminate any payments due Contractor, with a refund of the any fees prospectively paid from the date of breach.

(b) Year 2000 Warranty For all procurements of Product, Contractor must furnish a warranty statement in accordance with the NYS Standard Year 2000 Warranty Compliance Statement set forth in Part I at the time of bid for agency specific contracts or product order for centralized contracts.

(c) Virus Warranty Contractor represents and warrants that Licensed Software contains no known viruses. Bidder is not responsible for viruses introduced at Licensees site. For purposes of this provision, “Virus” shall have the meaning set forth in Part II, “Definitions”.

A breach of any of the foregoing shall be deemed a material breach of the Contract or any License granted thereunder. The defaulting party shall be given written notice of a warranty breach under this section and shall have a thirty (30) day period to cure such breach.

86. INDEMINIFICATION THE WARRANTIES SET FORTH IN THESE GENERAL SPECIFICATIONS (PARTS I and II) ARE IN LIEU OF ALL OTHER WARRANTIES, EXPRESS OR IMPLIED, INCLUDING BUT NOT LIMITED TO, THE IMPLIED WARRANTIES OF MERCHANTABILITY AND FITNESS FOR A PARTICULAR PURPOSE.

Contractor shall defend, indemnify and save harmless the County and Authorized Users from suits, actions, claims, damages and costs arising under or connected to Contractors actions, and except where express loss liabilities set forth elsewhere in the Contract provide for a higher loss limitation liability than as set forth in this paragraph, or where such express provisions impose Contractor liability on “without limitation”, the total liability of Contractor for such claim(s), regardless of the nature and basis for the claim, shall not exceed two (2) times the fees paid for the applicable Product. For any suit, action, claim, damages or costs arising under or are connected to personal injury or property damage, or breach of the title, patent and copyright warranties, Contractor shall be fully liable without limitation.

The County or Authorized User may retain such moneys from the amount due Contractor as may be necessary to satisfy any claim for damages, costs and the like asserted by or against the County or Authorized User, provided however, that Contractor shall not indemnify each such entity to the extent that any claim, loss or damages arising hereunder is caused by the negligence act or failure to act of said entity.

87. SOURCE CODE ESCROW FOR LICENSED PRODUCTS If source code or source code escrow is offered by either Contractor or Product manufacturer/developer to any other commercial customers, Contractor either: i) will provide Licensee with the Source Code for the Product; or ii) place the Source Code in a third party escrow arrangement with a designated escrow agent who shall be named and identified to the County, and who shall be directed to release the deposited Source Code in accordance with a standard escrow agreement acceptable to the County, or iii) will certify to the County that the Product manufacturer/developer has named the County, and the Licensee, as a named beneficiary of an established escrow arrangement with its designated escrow agent who shall be named and identified to the County and Licensee, and who shall be directed to release the deposited Source Code in accordance with the terms of escrow. Source Code, as well as any corrections or enhancements to such source code, shall be updated for each new release of the Product in the same manner as provided above. Contractor shall identify the escrow agent upon commencement of the contract term and shall certify annually that the escrow remains in effect in compliance with the terms of this paragraph.

The County may release the Source Code to Licensees under this Contract who have licensed Product or obtained services, who may use such copy of the Source Code to maintain the Product.



Andrew M. Cuomo, Governor

Roberta Reardon, Commissioner

Essex County
Donna Thompson, Sr Purchasing Clerk
7551 Court St.
Elizabethtown NY 12932

Schedule Year 2018 through 2019
Date Requested 12/13/2018
PRC# 2018014505

Location County Complex
Project ID#
Project Type Replace exterior metal stair

PREVAILING WAGE SCHEDULE FOR ARTICLE 8 PUBLIC WORK PROJECT

Attached is the current schedule(s) of the prevailing wage rates and prevailing hourly supplements for the project referenced above. A unique Prevailing Wage Case Number (PRC#) has been assigned to the schedule(s) for your project.

The schedule is effective from July 2018 through June 2019. All updates, corrections, posted on the 1st business day of each month, and future copies of the annual determination are available on the Department's website www.labor.state.ny.us. Updated PDF copies of your schedule can be accessed by entering your assigned PRC# at the proper location on the website.

It is the responsibility of the contracting agency or its agent to annex and make part, the attached schedule, to the specifications for this project, when it is advertised for bids and /or to forward said schedules to the successful bidder(s), immediately upon receipt, in order to insure the proper payment of wages.

Please refer to the "General Provisions of Laws Covering Workers on Public Work Contracts" provided with this schedule, for the specific details relating to other responsibilities of the Department of Jurisdiction.

Upon completion or cancellation of this project, enter the required information and mail **OR** fax this form to the office shown at the bottom of this notice, **OR** fill out the electronic version via the NYSDOL website.

NOTICE OF COMPLETION / CANCELLATION OF PROJECT

Date Completed: _____ Date Cancelled: _____

Name & Title of Representative: _____

Phone: (518) 457-5589 Fax: (518) 485-1870
W. Averell Harriman State Office Campus, Bldg. 12, Room 130, Albany, NY 12240

General Provisions of Laws Covering Workers on Article 8 Public Work Contracts

Introduction

The Labor Law requires public work contractors and subcontractors to pay laborers, workers, or mechanics employed in the performance of a public work contract not less than the prevailing rate of wage and supplements (fringe benefits) in the locality where the work is performed.

Responsibilities of the Department of Jurisdiction

A Department of Jurisdiction (Contracting Agency) includes a state department, agency, board or commission; a county, city, town or village; a school district, board of education or board of cooperative educational services; a sewer, water, fire, improvement and other district corporation; a public benefit corporation; and a public authority awarding a public work contract.

The Department of Jurisdiction (Contracting Agency) awarding a public work contract MUST obtain a Prevailing Rate Schedule listing the hourly rates of wages and supplements due the workers to be employed on a public work project. This schedule may be obtained by completing and forwarding a "Request for wage and Supplement Information" form (PW 39) to the Bureau of Public Work. The Prevailing Rate Schedule MUST be included in the specifications for the contract to be awarded and is deemed part of the public work contract.

Upon the awarding of the contract, the law requires that the Department of Jurisdiction (Contracting Agency) furnish the following information to the Bureau: the name and address of the contractor, the date the contract was let and the approximate dollar value of the contract. To facilitate compliance with this provision of the Labor Law, a copy of the Department's "Notice of Contract Award" form (PW 16) is provided with the original Prevailing Rate Schedule.

The Department of Jurisdiction (Contracting Agency) is required to notify the Bureau of the completion or cancellation of any public work project. The Department's PW 200 form is provided for that purpose.

Both the PW 16 and PW 200 forms are available for completion [online](#).

Hours

No laborer, worker, or mechanic in the employ of a contractor or subcontractor engaged in the performance of any public work project shall be permitted to work more than eight hours in any day or more than five days in any week, except in cases of extraordinary emergency. The contractor and the Department of Jurisdiction (Contracting Agency) may apply to the Bureau of Public Work for a dispensation permitting workers to work additional hours or days per week on a particular public work project. There are very few exceptions to this rule. Complete information regarding these exceptions is available on the "[4 Day / 10 Hour Work Schedule](#)" form (PW 30.1).

Wages and Supplements

The wages and supplements to be paid and/or provided to laborers, workers, and mechanics employed on a public work project shall be not less than those listed in the current Prevailing Rate Schedule for the locality where the work is performed. If a prime contractor on a public work project has not been provided with a Prevailing Rate Schedule, the contractor must notify the Department of Jurisdiction (Contracting Agency) who in turn must request an original Prevailing Rate Schedule from the Bureau of Public Work. Requests may be submitted by: mail to NYSDOL, Bureau of Public Work, State Office Bldg. Campus, Bldg. 12, Rm. 130, Albany, NY 12240; Fax to Bureau of Public Work (518) 485-1870; or electronically at the NYSDOL website www.labor.ny.gov.

Upon receiving the original schedule, the Department of Jurisdiction (Contracting Agency) is REQUIRED to provide complete copies to all prime contractors who in turn MUST, by law, provide copies of all applicable county schedules to each subcontractor and obtain from each subcontractor, an affidavit certifying such schedules were received. If the original schedule expired, the contractor may obtain a copy of the new annual determination from the NYSDOL website www.labor.ny.gov.

The Commissioner of Labor makes an annual determination of the prevailing rates. This determination is in effect from July 1st through June 30th of the following year. The annual determination is available on the NYSDOL website www.labor.ny.gov.

Payrolls and Payroll Records

Contractors and subcontractors are required to establish, maintain, and preserve for not less than six (6) years, contemporaneous, true, and accurate payroll records. Payrolls must show the following information for each person employed on a public work project: Name, Address, Last 4 Digits of Social Security Number, Classification(s) in which the worker was employed, Hourly wage rate(s) paid, Supplements paid or provided, and Daily and weekly number of hours worked in each classification.

The filing of payrolls to the Department of Jurisdiction is a condition of payment. Every contractor and subcontractor shall submit to the Department of Jurisdiction (Contracting Agency), within thirty (30) days after issuance of its first payroll and every thirty (30) days thereafter, a transcript of the original payrolls, subscribed and affirmed as true under penalty of perjury. The original payrolls or transcripts must be maintained for a period of at least (5) years, by the Department of Jurisdiction (Contracting Agency), from the project's date of completion. The Department of Jurisdiction (Contracting Agency) shall collect, review for facial validity, and maintain such payrolls.

In addition, the Commissioner of Labor may require contractors to furnish, with ten (10) days of a request, payroll records sworn to as their validity and accuracy for public work and private work. Payroll records include, but are not limited to time cards, work description sheets, proof that supplements were provided, cancelled payroll checks and payrolls. Failure to provide the requested information within the allotted ten (10) days will result in the withholding of up to 25% of the contract, not to exceed \$100,000.00. If the contractor or subcontractor does not maintain a place of business in New York State and the amount of the contract exceeds \$25,000.00, payroll records and certifications must be kept on the project worksite.

The prime contractor is responsible for any underpayments of prevailing wages or supplements by any subcontractor.

All contractors or their subcontractors shall provide to their subcontractors a copy of the Prevailing Rate Schedule specified in the public work contract as well as any subsequently issued schedules. A failure to provide these schedules by a contractor or subcontractor is a violation of Article 8, Section 220-a of the Labor Law.

All subcontractors engaged by a public work project contractor or its subcontractor, upon receipt of the original schedule and any subsequently issued schedules, shall provide to such contractor a verified statement attesting that the subcontractor has received the Prevailing Rate Schedule and will pay or provide the applicable rates of wages and supplements specified therein. (See NYS Labor Laws, Article 8 . Section 220-a).

Determination of Prevailing Wage and Supplement Rate Updates Applicable to All Counties

The wages and supplements contained in the annual determination become effective July 1st whether or not the new determination has been received by a given contractor. Care should be taken to review the rates for obvious errors. Any corrections should be brought to the Department's attention immediately. It is the responsibility of the public work contractor to use the proper rates. If there is a question on the proper classification to be used, please call the district office located nearest the project. Any errors in the annual determination will be corrected and posted to the NYSDOL website on the first business day of each month. Contractors are responsible for paying these updated rates as well, retroactive to July 1st.

When you review the schedule for a particular occupation, your attention should be directed to the dates above the column of rates. These are the dates for which a given set of rates is effective. To the extent possible, the Department posts rates in its possession that cover periods of time beyond the July 1st to June 30th time frame covered by a particular annual determination. Rates that extend beyond that instant time period are informational ONLY and may be updated in future annual determinations that actually cover the then appropriate July 1st to June 30th time period.

Withholding of Payments

When a complaint is filed with the Commissioner of Labor alleging the failure of a contractor or subcontractor to pay or provide the prevailing wages or supplements, or when the Commissioner of Labor believes that unpaid wages or supplements may be due, payments on the public work contract shall be withheld from the prime contractor in a sufficient amount to satisfy the alleged unpaid wages and supplements, including interest and civil penalty, pending a final determination.

When the Bureau of Public Work finds that a contractor or subcontractor on a public work project failed to pay or provide the requisite prevailing wages or supplements, the Bureau is authorized by Sections 220-b and 235.2 of the Labor Law to so notify the financial officer of the Department of Jurisdiction (Contracting Agency) that awarded the public work contract. Such officer MUST then withhold or cause to be withheld from any payment due the prime contractor on account of such contract the amount indicated by the Bureau as sufficient to satisfy the unpaid wages and supplements, including interest and any civil penalty that may be assessed by the Commissioner of Labor. The withholding continues until there is a final determination of the underpayment by the Commissioner of Labor or by the court in the event a legal proceeding is instituted for review of the determination of the Commissioner of Labor.

The Department of Jurisdiction (Contracting Agency) shall comply with this order of the Commissioner of Labor or of the court with respect to the release of the funds so withheld.

Summary of Notice Posting Requirements

The current Prevailing Rate Schedule must be posted in a prominent and accessible place on the site of the public work project. The prevailing wage schedule must be encased in, or constructed of, materials capable of withstanding adverse weather conditions and be titled "PREVAILING RATE OF WAGES" in letters no smaller than two (2) inches by two (2) inches.

The "[Public Work Project](#)" notice must be posted at the beginning of the performance of every public work contract, on each job site.

Every employer providing workers. compensation insurance and disability benefits must post notices of such coverage in the format prescribed by the Workers. Compensation Board in a conspicuous place on the jobsite.

Every employer subject to the NYS Human Rights Law must conspicuously post at its offices, places of employment, or employment training centers, notices furnished by the State Division of Human Rights.

Employers liable for contributions under the Unemployment Insurance Law must conspicuously post on the jobsite notices furnished by the NYS Department of Labor.

Apprentices

Employees cannot be paid apprentice rates unless they are individually registered in a program registered with the NYS Commissioner of Labor. The allowable ratio of apprentices to journeyworkers in any craft classification can be no greater than the statewide building trade ratios promulgated by the Department of Labor and included with the Prevailing Rate Schedule. An employee listed on a payroll as an apprentice who is not registered as above, must be paid the prevailing journeyworker's wage rate for the classification of work the employee is actually performing.

NYSDOL Labor Law, Article 8, Section 220-3, require that only apprentices individually registered with the NYS Department of Labor may be paid apprenticeship rates on a public work project. No other Federal or State Agency of office registers apprentices in New York State.

Persons wishing to verify the apprentice registration of any person must do so in writing by mail, to the NYSDOL Office of Employability Development / Apprenticeship Training, State Office Bldg. Campus, Bldg. 12, Albany, NY 12240 or by Fax to NYSDOL Apprenticeship Training (518) 457-7154. All requests for verification must include the name and social security number of the person for whom the information is requested.

The only conclusive proof of individual apprentice registration is written verification from the NYSDOL Apprenticeship Training Albany Central office. Neither Federal nor State Apprenticeship Training offices outside of Albany can provide conclusive registration information.

It should be noted that the existence of a registered apprenticeship program is not conclusive proof that any person is registered in that program. Furthermore, the existence or possession of wallet cards, identification cards, or copies of state forms is not conclusive proof of the registration of any person as an apprentice.

Interest and Penalties

In the event that an underpayment of wages and/or supplements is found:

- Interest shall be assessed at the rate then in effect as prescribed by the Superintendent of Banks pursuant to section 14-a of the Banking Law, per annum from the date of underpayment to the date restitution is made.
- A Civil Penalty may also be assessed, not to exceed 25% of the total of wages, supplements, and interest due.

Debarment

Any contractor or subcontractor and/or its successor shall be ineligible to submit a bid on or be awarded any public work contract or subcontract with any state, municipal corporation or public body for a period of five (5) years when:

- Two (2) willful determinations have been rendered against that contractor or subcontractor and/or its successor within any consecutive six (6) year period.
- There is any willful determination that involves the falsification of payroll records or the kickback of wages or supplements.

Criminal Sanctions

Willful violations of the Prevailing Wage Law (Article 8 of the Labor Law) may be a felony punishable by fine or imprisonment of up to 15 years, or both.

Discrimination

No employee or applicant for employment may be discriminated against on account of age, race, creed, color, national origin, sex, disability or marital status.

No contractor, subcontractor nor any person acting on its behalf, shall by reason of race, creed, color, disability, sex or national origin discriminate against any citizen of the State of New York who is qualified and available to perform the work to which the employment relates (NYS Labor Law, Article 8, Section 220-e(a)).

No contractor, subcontractor, nor any person acting on its behalf, shall in any manner, discriminate against or intimidate any employee on account of race, creed, color, disability, sex, or national origin (NYS Labor Law, Article 8, Section 220-e(b)).

The Human Rights Law also prohibits discrimination in employment because of age, marital status, or religion.

There may be deducted from the amount payable to the contractor under the contract a penalty of \$50.00 for each calendar day during which such person was discriminated against or intimidated in violation of the provision of the contract (NYS Labor Law, Article 8, Section 220-e(c)).

The contract may be cancelled or terminated by the State or municipality. All monies due or to become due thereunder may be forfeited for a second or any subsequent violation of the terms or conditions of the anti-discrimination sections of the contract (NYS Labor Law, Article 8, Section 220-e(d)).

Every employer subject to the New York State Human Rights Law must conspicuously post at its offices, places of employment, or employment training centers notices furnished by the State Division of Human Rights.

Workers' Compensation

In accordance with Section 142 of the State Finance Law, the contractor shall maintain coverage during the life of the contract for the benefit of such employees as required by the provisions of the New York State Workers' Compensation Law.

A contractor who is awarded a public work contract must provide proof of workers' compensation coverage prior to being allowed to begin work.

The insurance policy must be issued by a company authorized to provide workers' compensation coverage in New York State. Proof of coverage must be on form C-105.2 (Certificate of Workers' Compensation Insurance) and must name this agency as a certificate holder.

If New York State coverage is added to an existing out-of-state policy, it can only be added to a policy from a company authorized to write workers' compensation coverage in this state. The coverage must be listed under item 3A of the information page.

The contractor must maintain proof that subcontractors doing work covered under this contract secured and maintained a workers' compensation policy for all employees working in New York State.

Every employer providing worker's compensation insurance and disability benefits must post notices of such coverage in the format prescribed by the Workers' Compensation Board in a conspicuous place on the jobsite.

Unemployment Insurance

Employers liable for contributions under the Unemployment Insurance Law must conspicuously post on the jobsite notices furnished by the New York State Department of Labor.



Andrew M. Cuomo, Governor

Roberta Reardon, Commissioner

Essex County
Donna Thompson, Sr Purchasing Clerk
7551 Court St.
Elizabethtown NY 12932

Schedule Year 2018 through 2019
Date Requested 12/13/2018
PRC# 2018014505

Location County Complex
Project ID#
Project Type Replace exterior metal stair

Notice of Contract Award

New York State Labor Law, Article 8, Section 220.3a requires that certain information regarding the awarding of public work contracts, be furnished to the Commissioner of Labor. One "Notice of Contract Award" (PW 16, which may be photocopied), **MUST** be completed for **EACH** prime contractor on the above referenced project.

Upon notifying the successful bidder(s) of this contract, enter the required information and mail **OR** fax this form to the office shown at the bottom of this notice, **OR** fill out the electronic version via the NYSDOL website.

Contractor Information

All information must be supplied

Federal Employer Identification Number: _____		
Name: _____		
Address: _____ _____		
City: _____	State: _____	Zip: _____
Amount of Contract: \$ _____	Contract Type:	
Approximate Starting Date: ____/____/____	<input type="checkbox"/> (01) General Construction	
Approximate Completion Date: ____/____/____	<input type="checkbox"/> (02) Heating/Ventilation	
	<input type="checkbox"/> (03) Electrical	
	<input type="checkbox"/> (04) Plumbing	
	<input type="checkbox"/> (05) Other : _____	

Phone: (518) 457-5589 Fax: (518) 485-1870
W. Averell Harriman State Office Campus, Bldg. 12, Room 130, Albany, NY 12240

IMPORTANT NOTICE

FOR

CONTRACTORS & CONTRACTING AGENCIES

Social Security Numbers on Certified Payrolls

The Department of Labor is cognizant of the concerns of the potential for misuse or inadvertent disclosure of social security numbers. Identity theft is a growing problem and we are sympathetic to contractors' concerns with regard to inclusion of this information on payrolls if another identifier will suffice.

For these reasons, *the substitution of the use of the last four digits of the social security number on certified payrolls submitted to contracting agencies on public work projects is now acceptable to the Department of Labor.*

NOTE: This change does not affect the Department's ability to request and receive the entire social security number from employers during the course of its public work / prevailing wage investigations.

**To all State Departments, Agency Heads and Public Benefit Corporations
IMPORTANT NOTICE REGARDING PUBLIC WORK ENFORCEMENT FUND**

Budget Policy & Reporting Manual

B-610

Public Work Enforcement Fund

effective date December 7, 2005

1. Purpose and Scope:

This Item describes the Public Work Enforcement Fund (the Fund, PWEF) and its relevance to State agencies and public benefit corporations engaged in construction or reconstruction contracts, maintenance and repair, and announces the recently-enacted increase to the percentage of the dollar value of such contracts that must be deposited into the Fund. This item also describes the roles of the following entities with respect to the Fund:

- New York State Department of Labor (DOL),
- The Office of the State of Comptroller (OSC), and
- State agencies and public benefit corporations.

2. Background and Statutory References:

DOL uses the Fund to enforce the State's Labor Law as it relates to contracts for construction or reconstruction, maintenance and repair, as defined in subdivision two of Section 220 of the Labor Law. State agencies and public benefit corporations participating in such contracts are required to make payments to the Fund.

Chapter 511 of the Laws of 1995 (as amended by Chapter 513 of the Laws of 1997, Chapter 655 of the Laws of 1999, Chapter 376 of the Laws of 2003 and Chapter 407 of the Laws of 2005) established the Fund.

3. Procedures and Agency Responsibilities:

The Fund is supported by transfers and deposits based on the value of contracts for construction and reconstruction, maintenance and repair, as defined in subdivision two of Section 220 of the Labor Law, into which all State agencies and public benefit corporations enter.

Chapter 407 of the Laws of 2005 increased the amount required to be provided to this fund to .10 of one-percent of the total cost of each such contract, to be calculated at the time agencies or public benefit corporations enter into a new contract or if a contract is amended. The provisions of this bill became effective August 2, 2005.

**To all State Departments, Agency Heads and Public Benefit Corporations
IMPORTANT NOTICE REGARDING PUBLIC WORK ENFORCEMENT FUND**

OSC will report to DOL on all construction-related ("D") contracts approved during the month, including contract amendments, and then DOL will bill agencies the appropriate assessment monthly. An agency may then make a determination if any of the billed contracts are exempt and so note on the bill submitted back to DOL. For any instance where an agency is unsure if a contract is or is not exempt, they can call the Bureau of Public Work at the number noted below for a determination. Payment by check or journal voucher is due to DOL within thirty days from the date of the billing. DOL will verify the amounts and forward them to OSC for processing.

For those contracts which are not approved or administered by the Comptroller, monthly reports and payments for deposit into the Public Work Enforcement Fund must be provided to the Administrative Finance Bureau at the DOL within 30 days of the end of each month or on a payment schedule mutually agreed upon with DOL.

Reports should contain the following information:

- Name and billing address of State agency or public benefit corporation;
- State agency or public benefit corporation contact and phone number;
- Name and address of contractor receiving the award;
- Contract number and effective dates;
- Contract amount and PWEF assessment charge (if contract amount has been amended, reflect increase or decrease to original contract and the adjustment in the PWEF charge); and
- Brief description of the work to be performed under each contract.

Checks and Journal Vouchers, payable to the "New York State Department of Labor" should be sent to:

Department of Labor
Administrative Finance Bureau-PWEF Unit
Building 12, Room 464
State Office Campus
Albany, NY 12240

Any questions regarding billing should be directed to NYSDOL's Administrative Finance Bureau-PWEF Unit at (518) 457-3624 and any questions regarding Public Work Contracts should be directed to the Bureau of Public Work at (518) 457-5589.

Construction Industry Fair Play Act

Required Posting For Labor Law Article 25-B § 861-d

Construction industry employers must post the "Construction Industry Fair Play Act" notice in a prominent and accessible place on the job site.

Failure to post the notice can result in penalties of up to \$1,500 for a first offense and up to \$5,000 for a second offense.

The posting is included as part of this wage schedule. Additional copies may be obtained from the NYS DOL website, www.labor.ny.gov.

If you have any questions concerning the Fair Play Act, please call the State Labor Department toll-free at 1-866-435-1499 or email us at: dol.misclassified@labor.state.ny.us .

WORKER NOTIFICATION

(Labor Law §220, paragraph a of subdivision 3-a)

Effective February 24, 2008

This provision is an addition to the existing prevailing wage rate law, Labor Law §220, paragraph a of subdivision 3-a. It requires contractors and subcontractors to provide written notice to all laborers, workers or mechanics of the *prevailing wage rate* for their particular job classification *on each pay stub**. It also requires contractors and subcontractors to *post a notice* at the beginning of the performance of every public work contract *on each job site* that includes the telephone number and address for the Department of Labor and a statement informing laborers, workers or mechanics of their right to contact the Department of Labor if he/she is not receiving the proper prevailing rate of wages and/or supplements for his/her particular job classification. The required notification will be provided with each wage schedule, may be downloaded from our website www.labor.state.ny.us or made available upon request by contacting the Bureau of Public Work at 518-457-5589.

* In the event that the required information will not fit on the pay stub, an accompanying sheet or attachment of the information will suffice.

Attention Employees

THIS IS A: **PUBLIC WORK PROJECT**

If you are employed on this project as a **worker, laborer, or mechanic** you are entitled to receive the **prevailing wage and supplements rate** for the classification at which you are working.

Chapter 629 of the Labor Laws of 2007:

These wages are set by law and must be posted at the work site. They can also be found at:
www.labor.ny.gov

If you feel that you have not received proper wages or benefits, please call our nearest office.*

Albany	(518) 457-2744	Patchogue	(631) 687-4882
Binghamton	(607) 721-8005	Rochester	(585) 258-4505
Buffalo	(716) 847-7159	Syracuse	(315) 428-4056
Garden City	(516) 228-3915	Utica	(315) 793-2314
New York City	(212) 932-2419	White Plains	(914) 997-9507
Newburgh	(845) 568-5156		

* For New York City government agency construction projects, please contact the Office of the NYC Comptroller at (212) 669-4443, or www.comptroller.nyc.gov – click on Bureau of Labor Law.

Contractor Name: _____

Project Location: _____

OSHA 10-hour Construction Safety and Health Course – S1537-A

Effective July 18, 2008

This provision is an addition to the existing prevailing wage rate law, Labor Law §220, section 220-h. It requires that on all public work projects of at least \$250,000.00, all laborers, workers and mechanics working on the site, be certified as having successfully completed the OSHA 10-hour construction safety and health course. It further requires that the advertised bids and contracts for every public work contract of at least \$250,000.00, contain a provision of this requirement.

NOTE: The OSHA 10 Legislation only applies to workers on a public work project that are required, under Article 8, to receive the prevailing wage.

Where to find OSHA 10-hour Construction Course

1. NYS Department of Labor website for scheduled outreach training at:

www.labor.state.ny.us/workerprotection/safetyhealth/DOSH_ONSITE_CONSULTATION.shtm

2. OSHA Training Institute Education Centers:

Rochester Institute of Technology OSHA Education Center

Rochester, NY

Donna Winter

Fax (585) 475-6292

e-mail: dlwtpo@rit.edu

(866) 385-7470 Ext. 2919

www.rit.edu/~outreach/course.php3?CourseID=54

Atlantic OSHA Training Center

UMDNJ – School of Public Health

Piscataway, NJ

Janet Crooks

Fax (732) 235-9460

e-mail: crooksje@umdnj.edu

(732) 235-9455

<https://ophp.umdnj.edu/wconnect/ShowSchedule.awp?~~GROUP~AOTCON~10~>

Atlantic OSHA Training Center

University at Buffalo

Buffalo, New York

Joe Syracuse

Fax (716) 829-2806

e-mail: mailto:japs@buffalo.edu

(716) 829-2125

http://www.smbs.buffalo.edu/CENTERS/trc/schedule_OSHA.php

Keene State College

Manchester, NH

Leslie Singleton

e-mail: lsingletin@keene.edu

(800) 449-6742

www.keene.edu/courses/print/courses_osh.cfm

3. List of trainers and training schedules for OSHA outreach training at:

www.OutreachTrainers.org

Requirements for OSHA 10 Compliance

Chapter 282 of the Laws of 2007, codified as Labor Law 220-h took effect on July 18, 2008. The statute provides as follows:

The advertised specifications for every contract for public work of \$250,000.00 or more must contain a provision requiring that every worker employed in the performance of a public work contract shall be certified as having completed an OSHA 10 safety training course. The clear intent of this provision is to require that all employees of public work contractors, required to be paid prevailing rates, receive such training “prior to the performing any work on the project.”

The Bureau will enforce the statute as follows:

All contractors and sub contractors must attach a copy of proof of completion of the OSHA 10 course to the first certified payroll submitted to the contracting agency and on each succeeding payroll where any new or additional employee is first listed.

Proof of completion may include but is not limited to:

- Copies of bona fide course completion card (*Note: Completion cards do not have an expiration date.*)
- Training roster, attendance record of other documentation from the certified trainer pending the issuance of the card.
- Other valid proof

**A certification by the employer attesting that all employees have completed such a course is not sufficient proof that the course has been completed.

Any questions regarding this statute may be directed to the New York State Department of Labor, Bureau of Public Work at 518-485-5696.

WICKS Reform 2008

(For all contracts advertised or solicited for bid on or after 7/1/08)

- Raises the threshold for public work projects subject to the Wicks Law requiring separate specifications and bidding for the plumbing, heating and electrical work. The total project's threshold would increase from \$50,000 to: \$3 million in Bronx, Kings, New York, Queens and Richmond counties; \$1.5 million in Nassau, Suffolk and Westchester counties; and \$500,000 in all other counties.
- For projects below the monetary threshold, bidders must submit a sealed list naming each subcontractor for the plumbing, HVAC and electrical work and the amount to be paid to each. The list may not be changed unless the public owner finds a legitimate construction need, including a change in specifications or costs or use of a Project Labor Agreement (PLA), and must be open to public inspection.
- Allows the state and local agencies and authorities to waive the Wicks Law and use a PLA if it will provide the best work at the lowest possible price. If a PLA is used, all contractors shall participate in apprentice training programs in the trades of work it employs that have been approved by the Department of Labor (DOL) for not less than three years. They shall also have at least one graduate in the last three years and use affirmative efforts to retain minority apprentices. PLA's would be exempt from Wicks, but deemed to be public work subject to prevailing wage enforcement.
- The Commissioner of Labor shall have the power to enforce separate specification requirements on projects, and may issue stop-bid orders against public owners for non-compliance.
- Other new monetary thresholds, and similar sealed bidding for non-Wicks projects, would apply to certain public authorities including municipal housing authorities, NYC Construction Fund, Yonkers Educational Construction Fund, NYC Municipal Water Finance Authority, Buffalo Municipal Water Finance Authority, Westchester County Health Care Association, Nassau County Health Care Corp., Clifton-Fine Health Care Corp., Erie County Medical Center Corp., NYC Solid Waste Management Facilities, and the Dormitory Authority.
- Reduces from 15 to 7 days the period in which contractors must pay subcontractors.

IMPORTANT INFORMATION

**Regarding Use of Form PW30.1
(Previously 30R)**

“Employer Registration for Use of 4 Day / 10 Hour Work Schedule”

To use the ‘4 Day / 10 Hour Work Schedule’:

There **MUST** be a *Dispensation of Hours (PW30)* in place on the project

AND

You **MUST** register your intent to work 4 / 10 hour days, by completing the PW30.1 Form.

REMEMBER...

The ‘4 Day / 10 Hour Work Schedule’ applies **ONLY** to Job Classifications and Counties listed on the PW30.1 Form.

Do not write in any additional Classifications or Counties.

(Please note : For each Job Classification check the individual wage schedule for specific details regarding their 4/10 hour day posting.)

Instructions for Completing Form PW30.1

(Previously 30R)

“Employer Registration for Use of 4 Day / 10 Hour Work Schedule”

Before completing Form PW30.1 check to be sure ...

- There is a *Dispensation of Hours* in place on the project.
- The 4 Day / 10 Hour Work Schedule applies to the Job Classifications you will be using.
- The 4 Day / 10 Hour Work Schedule applies to the County / Counties where the work will take place.

Instructions (Type or Print legibly):

Contractor Information:

- Enter the Legal Name of the business, FEIN, Street Address, City, State, Zip Code; the Company’s Phone and Fax numbers; and the Company’s email address (if applicable)
- Enter the Name of a Contact Person for the Company along with their Phone and Fax numbers, and the personal email address (if applicable)

Project Information:

- Enter the Prevailing Rate Case number (PRC#) assigned to this project
- Enter the Project Name / Type (i.e. Smithtown CSD – Replacement of HS Roof)
- Enter the Exact Location of Project (i.e. Smithtown HS, 143 County Route #2, Smithtown, NY; Bldgs. 1 & 2)
- If you are a Subcontractor, enter the name of the Prime Contractor for which you work
- On the Checklist of Job Classifications -
 - Go to pages 2 and 3 of the form
 - Place a checkmark in the box to the right of the Job Classification you are choosing
 - Mark all Job Classifications that apply

****Do not write in any additional Classifications or Counties.****

Requestor Information:

- Enter the name of the person submitting the registration, their title with the company , and the date the registration is filled out

Return Completed Form:

- **Mail** the completed PW30.1 form to: NYSDOL Bureau of Public Work, SOBC – Bldg.12 – Rm.130, Albany, NY 12240 **-OR-**
- **Fax** the completed PW30.1 form to: NYSDOL Bureau of Public Work at (518)485-1870



Bureau of Public Work Harriman
State Office Campus
Building 12, Room 130
Albany, New York 12240
Phone: (518) 457-5589 | Fax: (518) 485-1870
www.labor.ny.gov

Employer Registration for Use of 4 Day / 10 Hour Work Schedule

Before completing this form, make sure that:

- There is a Dispensation of Hours in place on the project.
The 4 Day / 10 Hour Work Schedule applies to the Job Classifications you will be using.
The 4 Day / 10 Hour Work Schedule applies to the County / Counties where the work will take place.

Please type or print the requested information and then mail or fax to the address above.

Contractor Information

Company Name: FEIN:
Address:
City: State: Zip Code:
Phone No: Fax No: Email:
Contact Person:
Phone No: Fax No: Email:

Project Information

Project PRC#: Project Name/Type:
Exact Location of Project: County:
(If you are Subcontractor)
Prime Contractor Name:

Job Classification(s) to Work 4/10 Schedule: (Choose all that apply on Job Classification Checklist - Pages 3-8)
*** Do not write in any additional Classifications or Counties***

Requestor Information

Name:
Title: Date:

Please use the list below with the number assigned to each county as a reference to the corresponding numbers listed in the following pages under **Entire Counties & Partial Counties**.

- | | | | |
|-----|-----------------------------|-----|---------------------------------|
| 1. | Albany County | 33. | Oneida County |
| 2. | Allegany County | 34. | Onondaga County |
| 3. | Bronx County | 35. | Ontario County |
| 4. | Broome County | 36. | Orange County |
| 5. | Cattaraugus County | 37. | Orleans County |
| 6. | Cayuga County | 38. | Oswego County |
| 7. | Chautauqua County | 39. | Otsego County |
| 8. | Chemung County | 40. | Putnam County |
| 9. | Chenango County | 41. | Queens County |
| 10. | Clinton County | 42. | Rensselaer County |
| 11. | Columbia County | 43. | Richmond County (Staten Island) |
| 12. | Cortland County | 44. | Rockland County |
| 13. | Delaware County | 45. | Saint Lawrence County |
| 14. | Dutchess County | 46. | Saratoga County |
| 15. | Erie County | 47. | Schenectady County |
| 16. | Essex County | 48. | Schoharie County |
| 17. | Franklin County | 49. | Schuyler County |
| 18. | Fulton County | 50. | Seneca County |
| 19. | Genesee County | 51. | Steuben County |
| 20. | Greene County | 52. | Suffolk County |
| 21. | Hamilton County | 53. | Sullivan County |
| 22. | Herkimer County | 54. | Tioga County |
| 23. | Jefferson County | 55. | Tompkins County |
| 24. | Kings County (Brooklyn) | 56. | Ulster County |
| 25. | Lewis County | 57. | Warren County |
| 26. | Livingston County | 58. | Washington County |
| 27. | Madison County | 59. | Wayne County |
| 28. | Monroe County | 60. | Westchester County |
| 29. | Montgomery County | 61. | Wyoming County |
| 30. | Nassau County | 62. | Yates County |
| 31. | New York County (Manhattan) | | |
| 32. | Niagara County | | |

Job Classification Checklist

(Place a checkmark by all classifications that will be using the 4/10 schedule)

**** Do not write in any additional Classifications or Counties****

Job Classification	Tag #	Entire Counties	Partial Counties	Check Box
Carpenter – Building	276B-All	7	2, 5	
Carpenter – Building	276B-Cat	15	5	
Carpenter – Building	276-B-LIV	26, 28, 35, 59	61	
Carpenter – Building	276B-Gen	19, 32, 37	61	
Carpenter – Heavy & Highway	276HH-All	2, 5, 7		
Carpenter – Heavy & Highway	276HH-Erie	15		
Carpenter – Heavy & Highway	276HH- Gen	19, 32, 37, 61		
Carpenter – Heavy & Highway	276HH-Liv	26, 28, 35, 59		
Carpenter – Residential	276R-All	7	2, 5	
Carpenter – Building	277B-Bro	4, 54		
Carpenter – Building	277B-CAY	6, 50, 62		
Carpenter – Building	277B-CS	8, 12, 49, 51, 55	2	
Carpenter – Building	277 JLS	23, 25, 45		
Carpenter – Building	277 omh	22, 27, 33		
Carpenter – Building	277 On	34		
Carpenter – Building	277 Os	38		
Carpenter – Building	277CDO Bldg	9, 13, 39		
Carpenter – Heavy & Highway	277CDO HH	9, 13, 39		
Carpenter – Heavy & Highway	277HH-BRO	4, 6, 8, 12, ,22, 23, 25, 27, 33, 34, 38, 45, 49, 50, 51, 54, 55, 62		
Carpenter – Building	291B-Alb	1, 18, 20, 29, 42, 47, 48		
Carpenter – Building	291B-Cli	10, 16, 17		
Carpenter – Building	291B-Ham	21, 57, 58		
Carpenter – Building	291B-Sar	46		
Carpenter – Heavy & Highway	291HH-Alb	1, 10, 16, 17,18, 20, 21, 29, 42, 46, 47, 48, 57, 58		
Electrician	25m	30, 52		
Electrician – Teledata Cable Splicer	43	12, 22, 27, 33, 38	6, 9, 34, 39, 55, 59	

Job Classification Checklist

(Place a checkmark by all classifications that will be using the 4/10 schedule)

**** Do not write in any additional Classifications or Counties****

Job Classification	Tag #	Entire Counties	Partial Counties	Check Box
Electrician	86	26, 28	19, 35, 37, 59, 61	
Electrician	840 Teledata and 840 Z1	62	6, 34, 35, 50, 59	
Electrician	910	10, 16, 17, 23, 25, 45		
Electrical Lineman	1049Line/Gas	30, 41, 52		
Electrical Lineman	1249a	1, 2, 4, 5, 6, 7, 8, 9, 10, 11, 12, 13, 14, 15, 16, 17, 18, 19, 20, 21, 22, 23, 25, 26, 27, 28, 29, 32, 33, 34, 35, 36, 37, 38, 39, 40, 42, 44, 46, 47, 48, 49, 50, 45, 51, 53, 54, 55, 56, 57, 58, 59, 61, 62		
Electrical Lineman	1249a West	60		
Electrical Lineman	1249a-LT	1, 2, 4, 5, 6, 7, 8, 9, 10, 12, 13, 15, 16, 17, 18, 19, 20, 21, 22, 23, 25, 26, 27, 28, 29, 32, 33, 34, 35, 37, 38, 39, 42, 46, 47, 48, 49, 50, 45, 51, 53, 54, 55, 57, 58, 59, 61, 62		
Electrical Lineman	1249aREG8LT	11, 14, 36, 40, 44, 56		
Electrical Lineman	1249aWestLT	60		
Elevator Constructor	138	11, 14, 20, 36, 40, 53, 56	13, 44, 60	
Elevator Constructor	14	2, 5, 7, 15, 19, 32, 37, 61		
Elevator Constructor	27	8, 26, 28, 35, 49, 50, 51, 59, 62		
Elevator Constructor	35	1, 10, 16, 18, 21, 22, 29, 39, 42, 46, 47, 48, 57, 58		
Elevator Constructor	62.1	4, 6, 9, 12, 23, 25, 27, 33, 34, 38, 45, 54, 55	13	
Glazier	201	1, 10, 11, 16, 17, 18, 20, 21, 29, 42, 46, 47, 48, 57, 58		
Glazier	660r	2, 5, 7, 15, 19, 32, 37, 61		
Glazier	660	2, 5, 7, 15, 19, 32, 37, 61		
Glazier	677.1	23, 25, 26, 28, 35, 45, 50, 59, 62		
Glazier	677Z-2	6, 12, 22, 27, 33, 34, 38		
Glazier	677z3	4, 8, 9, 13, 39, 49, 51, 54, 55		
Glazier	677r.2	6, 12, 22, 27, 33, 34, 38		
Insulator – Heat & Frost	30-Syracuse	4, 6, 8, 9, 12, 22, 23, 25, 27, 33, 34, 38, 39, 49, 50, 45, 54, 55		
Laborer – Building	621b	2, 7	5	
Laborer – Building	633 bON	34		

Job Classification Checklist

(Place a checkmark by all classifications that will be using the 4/10 schedule)

*** Do not write in any additional Classifications or Counties***

Job Classification	Tag #	Entire Counties	Partial Counties	Check Box
Laborer – Building	633b Cay	6		
Laborer – Building	633bOS	38		
Laborer – Building	785(7)	4	9, 13, 54	
Laborer – Building	785B-CS	8, 51	49	
Laborer – Building	7-785b	12, 55	49, 54	
Laborers – Heavy & Highway	157h/h	47	18, 29, 46	
Laborers – Heavy & Highway	190 h/h	1, 42, 58	11, 20, 46	
Laborers – Heavy & Highway	35/2h	21, 22, 27, 33	18, 29	
Laborer – Residential	621r	2, 7	5	
Laborers – Tunnel	157	47	18, 29, 46	
Laborers – Tunnel	35T	21, 22, 27, 33	18, 29	
Laborers – Tunnel	190	1, 42, 58	11, 20, 46	
Mason – Building	2TS.1	1, 10, 11, 16, 17, 18, 20, 21, 29, 42, 46, 47, 48, 57, 58		
Mason – Building	2TS.2	22, 23, 25, 33, 45	27	
Mason – Building	2TS.3	6, 34, 38	27	
Mason – Building	2b-on	34		
Mason – Building	2b.1	1, 11, 18, 20, 21, 29, 42, 46, 47, 48, 58	57	
Mason – Building	2b.2	22, 33	25	
Mason – Building	2b.3	6, 34	27	
Mason – Building	2b.4	38		
Mason – Building	2b.5	23	25	
Mason – Building	2b.6	45		
Mason – Building	2b.8	10, 16, 17	57	
Mason – Building	3b-Co-Z2	8, 49, 51	2	
Mason – Building	3B-Z1	19, 26, 28, 35, 50, 59, 61, 62		
Mason – Building – Residential	3B-Z1R	19, 26, 28, 35, 50, 59, 61, 62		
Mason – Building	3B-Bing-Z2	4, 9, 13, 39, 54		
Mason – Building	3B-lth-Z2	12, 55		

Job Classification Checklist

(Place a checkmark by all classifications that will be using the 4/10 schedule)

**** Do not write in any additional Classifications or Counties****

Job Classification	Tag #	Entire Counties	Partial Counties	Check Box
Mason – Building	3B-Jam-Z2	7	2, 5	
Mason – Building – Residential	3B-Jam-Z2R	2, 4, 8, 7, 9, 12, 39, 13, 49, 51, 54, 55	5	
Mason – Building	3B-Z3	15, 32	5	
Mason – Building	3B-Z3.Orleans	37		
Mason – Residential	3B-Z3R	15, 32	5	
Mason – Residential	3B-z3R.Orleans	37		
Mason - Heavy & Highway	3h	2, 4, 8, 7, 9, 12, 13, 19, 26, 28, 35, 37, 39, 49, 50, 51, 54, 55, 59, 61, 62	5, 15, 32	
Mason – Tile Finisher	3TF-Z1	19, 26, 28, 35, 50, 59, 61, 62		
Mason – Tile Finisher	3TF-Z2	2, 4, 8, 7, 9, 12, 13, 39, 49, 51, 54, 55	5	
Mason – Tile Finisher	3TF-Z3	15, 32, 37	5	
Mason – Tile Finisher	3TF-Z1R	19, 26, 28, 35, 50, 59, 61, 62		
Mason – Tile Finisher	3TF-Z2R	2, 4, 7, 9, 12, 13, 39, 49, 51, 54, 55	5	
Mason – Tile Finisher	3TF-Z3R	15, 32, 37	5	
Mason – Tile Setter	3TS-Z1	19, 26, 28, 35, 50, 59, 61, 62		
Mason – Tile Setter Residential	3TS-Z1R	19, 26, 28, 35, 50, 59, 61, 62		
Mason – Tile Setter	3TS-Z2	2, 4, 7, 8, 9, 12, 13, 39, 49, 51, 54, 55	5	
Mason – Tile Setter Residential	3TS-Z2R	2, 4, 7, 8, 9, 12, 13, 39, 49, 51, 54, 55	5	
Mason – Tile Setter	3TS-Z3	15, 32, 37	5	
Mason – Tile Setter Residential	3TS-Z3R	15, 32, 37	5	
Mason – Building/Heavy & Highway	780	3, 24, 30, 31, 41, 43, 52		
Operating Engineer - Heavy & Highway	137H/H	40, 60	14	
Operating Engineer – Heavy & Highway	158-832H	2, 8, 26, 28, 35, 49, 51, 59, 62	19	
Operating Engineer – Heavy & Highway	158-H/H	1, 4, 9, 10, 11, 14, 16, 17, 18, 20, 21, 22, 29, 39, 42, 46, 47, 48, 54, 57, 58		
Operating Engineer – Heavy & Highway	158-545h	6, 12, 23, 25, 27, 33, 38, 45, 50, 55		
Painter	1456-LS	1, 3, 10, 11, 14, 16, 17, 18, 20, 21, 24, 29, 30, 31, 36, 40, 41, 42, 43, 44, 46, 47, 48, 52, 53, 56, 57, 58, 60		
Painter	150	28, 59, 62	26, 35	

Job Classification Checklist

(Place a checkmark by all classifications that will be using the 4/10 schedule)

**** Do not write in any additional Classifications or Counties****

Job Classification	Tag #	Entire Counties	Partial Counties	Check Box
Painter	178 B	4, 9, 54		
Painter	178 E	8, 49	51	
Painter	178 I	12, 55		
Painter	178 O	13, 39		
Painter	31	6, 22, 27, 33, 34, 50	25, 35, 38	
Painter	38.O		38	
Painter	38.W	23, 45	25	
Painter	4- Buf,Nia,Olean	2, 15, 19, 32, 37, 61	5, 7, 26, 51	
Painter	4-Jamestown		5, 7	
Sheetmetal Worker	46	26, 28, 35, 50, 59, 62		
Sheetmetal Worker	46r	26, 28, 35, 50, 59, 62		
Teamsters – Heavy & Highway	294h/h	1, 11, 18, 20, 29, 42, 46, 47, 48, 58	57	
Teamsters – Heavy & Highway	317bhh	6, 12, 50, 51, 55, 62	2	
Teamsters - Building/Heavy & Highway	456	40, 60		

Introduction to the Prevailing Rate Schedule

Information About Prevailing Rate Schedule

This information is provided to assist you in the interpretation of particular requirements for each classification of worker contained in the attached Schedule of Prevailing Rates.

Classification

It is the duty of the Commissioner of Labor to make the proper classification of workers taking into account whether the work is heavy and highway, building, sewer and water, tunnel work, or residential, and to make a determination of wages and supplements to be paid or provided. It is the responsibility of the public work contractor to use the proper rate. If there is a question on the proper classification to be used, please call the district office located nearest the project. District office locations and phone numbers are listed below.

Prevailing Wage Schedules are issued separately for "General Construction Projects" and "Residential Construction Projects" on a county-by-county basis.

General Construction Rates apply to projects such as: Buildings, Heavy & Highway, and Tunnel and Water & Sewer rates.

Residential Construction Rates generally apply to construction, reconstruction, repair, alteration, or demolition of one family, two family, row housing, or rental type units intended for residential use.

Some rates listed in the Residential Construction Rate Schedule have a very limited applicability listed along with the rate. Rates for occupations or locations not shown on the residential schedule must be obtained from the General Construction Rate Schedule. Please contact the local Bureau of Public Work office before using Residential Rate Schedules, to ensure that the project meets the required criteria.

Payrolls and Payroll Records

Contractors and subcontractors are required to establish, maintain, and preserve for not less than six (6) years, contemporaneous, true, and accurate payroll records.

Every contractor and subcontractor shall submit to the Department of Jurisdiction (Contracting Agency), within thirty (30) days after issuance of its first payroll and every thirty (30) days thereafter, a transcript of the original payrolls, subscribed and affirmed as true under penalty of perjury.

Paid Holidays

Paid Holidays are days for which an eligible employee receives a regular day's pay, but is not required to perform work. If an employee works on a day listed as a paid holiday, this remuneration is in addition to payment of the required prevailing rate for the work actually performed.

Overtime

At a minimum, all work performed on a public work project in excess of eight hours in any one day or more than five days in any workweek is overtime. However, the specific overtime requirements for each trade or occupation on a public work project may differ. Specific overtime requirements for each trade or occupation are contained in the prevailing rate schedules.

Overtime holiday pay is the premium pay that is required for work performed on specified holidays. It is only required where the employee actually performs work on such holidays.

The applicable holidays are listed under HOLIDAYS: OVERTIME. The required rate of pay for these covered holidays can be found in the OVERTIME PAY section listings for each classification.

Supplemental Benefits

Particular attention should be given to the supplemental benefit requirements. Although in most cases the payment or provision of supplements is straight time for all hours worked, some classifications require the payment or provision of supplements, or a portion of the supplements, to be paid or provided at a premium rate for premium hours worked. Supplements may also be required to be paid or provided on paid holidays, regardless of whether the day is worked. The Overtime Codes and Notes listed on the particular wage classification will indicate these conditions as required.

Effective Dates

When you review the schedule for a particular occupation, your attention should be directed to the dates above the column of rates. These are the dates for which a given set of rates is effective. The rate listed is valid until the next effective rate change or until the new annual determination which takes effect on July 1 of each year. All contractors and subcontractors are required to pay the current prevailing rates of wages and supplements. If you have any questions please contact the Bureau of Public Work or visit the New York State Department of Labor website (www.labor.state.ny.us) for current wage rate information.

Apprentice Training Ratios

The following are the allowable ratios of registered Apprentices to Journey-workers.

For example, the ratio 1:1,1:3 indicates the allowable initial ratio is one Apprentice to one Journeyworker. The Journeyworker must be in place on the project before an Apprentice is allowed. Then three additional Journeyworkers are needed before a second Apprentice is allowed. The last ratio repeats indefinitely. Therefore, three more Journeyworkers must be present before a third Apprentice can be hired, and so on.

Please call Apprentice Training Central Office at (518) 457-6820 if you have any questions.

Title (Trade)	Ratio
Boilermaker (Construction)	1:1,1:4
Boilermaker (Shop)	1:1,1:3
Carpenter (Bldg.,H&H, Pile Driver/Dockbuilder)	1:1,1:4
Carpenter (Residential)	1:1,1:3
Electrical (Outside) Lineman	1:1,1:2
Electrician (Inside)	1:1,1:3
Elevator/Escalator Construction & Modernizer	1:1,1:2
Glazier	1:1,1:3
Insulation & Asbestos Worker	1:1,1:3
Iron Worker	1:1,1:4
Laborer	1:1,1:3
Mason	1:1,1:4
Millwright	1:1,1:4
Op Engineer	1:1,1:5
Painter	1:1,1:3
Plumber & Steamfitter	1:1,1:3
Rofer	1:1,1:2
Sheet Metal Worker	1:1,1:3
Sprinkler Fitter	1:1,1:2

If you have any questions concerning the attached schedule or would like additional information, please contact the nearest BUREAU of PUBLIC WORK District Office or write to:

New York State Department of Labor
Bureau of Public Work
State Office Campus, Bldg. 12
Albany, NY 12240

District Office Locations:	Telephone #	FAX #
Bureau of Public Work - Albany	518-457-2744	518-485-0240
Bureau of Public Work - Binghamton	607-721-8005	607-721-8004
Bureau of Public Work - Buffalo	716-847-7159	716-847-7650
Bureau of Public Work - Garden City	516-228-3915	516-794-3518
Bureau of Public Work - Newburgh	845-568-5287	845-568-5332
Bureau of Public Work - New York City	212-932-2419	212-775-3579
Bureau of Public Work - Patchogue	631-687-4882	631-687-4902
Bureau of Public Work - Rochester	585-258-4505	585-258-4708
Bureau of Public Work - Syracuse	315-428-4056	315-428-4671
Bureau of Public Work - Utica	315-793-2314	315-793-2514
Bureau of Public Work - White Plains	914-997-9507	914-997-9523
Bureau of Public Work - Central Office	518-457-5589	518-485-1870

Essex County General Construction

Boilermaker **12/01/2018**

JOB DESCRIPTION Boilermaker **DISTRICT 1**

ENTIRE COUNTIES

Albany, Broome, Chenango, Columbia, Delaware, Essex, Fulton, Greene, Hamilton, Herkimer, Montgomery, Otsego, Rensselaer, Saratoga, Schenectady, Schoharie, Tioga, Warren, Washington

WAGES

Per hour	07/01/2018	01/01/2019	01/01/2020
Boilermaker	\$ 35.99	+1.30	+1.30

SUPPLEMENTAL BENEFITS

Per hour	
Journeymen	\$ 24.25 + 1.24*

* This portion of the benefit is NOT subject to the SAME PREMIUM as shown for overtime.

OVERTIME PAY

See (B, E, Q, V) on OVERTIME PAGE

HOLIDAY

Paid: See (1) on HOLIDAY PAGE
 Overtime: See (5, 6, 15, 25) on HOLIDAY PAGE

Note: When a holiday falls on Sunday, the day observed by the State or Nation shall be observed, and when Christmas Day and New Year's fall on Saturday, Friday will be observed as the holiday.

REGISTERED APPRENTICES

Wages per hour
 (1/2) year terms at the following percentage of Journeyman's wage.

1st	2nd	3rd	4th	5th	6th	7th	8th
65%	65%	70%	75%	80%	85%	90%	95%

Supplemental Benefits per hour

1st	2nd	3rd	4th	5th	6th	7th	8th
18.24*	18.24*	19.11*	19.97*	20.82	21.67*	22.54*	23.40*
+1.24	+1.24	+1.24	+1.24	+1.24	+1.24	+1.24	+1.24

* This portion of the benefit is subject to the SAME PREMIUM as shown for overtime.

1-197

Carpenter - Building **12/01/2018**

JOB DESCRIPTION Carpenter - Building **DISTRICT 2**

ENTIRE COUNTIES

Clinton, Essex, Franklin

WAGES

Per hour:	07/01/2018	07/01/2019	07/01/2020
		Additional	Additional
Carpenter	\$ 27.17	\$ 1.00	\$ 1.00
Floor Coverer	27.17	1.00	1.00
Carpet Layer	27.17	1.00	1.00
Dry-Wall	27.17	1.00	1.00
Lather	27.17	1.00	1.00
Diver-Wet Day	61.25	0.00	0.00
Diver-Dry Day	28.17	1.00	1.00
Diver Tender	28.17	1.00	1.00

NOTE ADDITIONAL AMOUNTS PAID FOR THE FOLLOWING WORK LISTED BELOW (not subject to overtime premiums):

- Pile Drivers shall receive \$0.25 per hour over the journeyman's rate of pay when performing piledriving work.
- Certified welders shall receive \$1.00 per hour over the journeyman's rate of pay when the employee is required to be certified and performs DOT or ABS specified welding work

- When an employee performs work within a contaminated area on a State and/or Federally designated hazardous waste site, and where relevant State and/or Federal regulations require employees to be furnished and use or wear required forms of personal protection, then the employee shall receive his regular hourly rate plus \$1.50 per hour.
- Depth pay for Divers based upon deepest depth on the day of the dive:
 - 0' to 80' no additional fee
 - 81' to 100' additional \$.50 per foot
 - 101' to 150' additional \$0.75 per foot
 - 151" and deeper additional \$1.25 per foot
- Penetration pay for Divers based upon deepest penetration on the day of the dive:
 - 0' to 50' no additional fee
 - 51' to 100' additional \$.75 per foot
 - 101' and deeper additional \$1.00 per foot

Four (4), ten (10) hour days may be worked at straight time during a week, Monday thru Thursday. Friday may be used as a make-up day.

NOTE - In order to use the "4 Day/10 Hour Work schedule", as your normal schedule, you must submit an "Employer Registration for Use of 4 Day/10 Hour Work Schedule," form PW30.1; and there must be a dispensation of hours in place on the project. If the PW30.1 is not submitted you may be liable for overtime payments for work over 8 hours per day.

SUPPLEMENTAL BENEFITS

Per hour:

Journeyman \$ 19.89

OVERTIME PAY

See (B, E, *E2, Q) on OVERTIME PAGE

* Note - Saturday is payable at straight time if the employee misses work, except where a doctor's or hospital verification of illness is produced Monday through Friday when work was available to the employee.

HOLIDAY

Paid: See (1) on HOLIDAY PAGE

Overtime: See (5, 6) on HOLIDAY PAGE

Note: Any holiday which occurs on Sunday shall be observed the following Monday. If Christmas falls on a Saturday, it shall be observed on the prior Friday.

REGISTERED APPRENTICES

Wages per hour

FOR APPRENTICES INDENTURED PRIOR TO JANUARY 1, 2016

One year terms at the following percentage of Journeyman's base wage.

1st	2nd	3rd	4th
50%	60%	70%	80%

Supplemental Benefits per hour:

1st year term	\$ 11.06
2nd year term	11.06
3rd year term	13.66
4th year term	13.66

FOR APPRENTICES INDENTURED AFTER JANUARY 1, 2016

1,300 hour terms at the following percentage of Journeyman's base wage.

1st	2nd	3rd	4th	5th
50%	60%	65%	70%	80%

Supplemental Benefits per hour:

1st term	\$ 11.06
2nd term	11.06
3rd term	13.66
4th term	13.66
5th term	13.66

ADDITIONAL AMOUNTS PAID TO APPRENTICES FOR SPECIFIC TYPES OF WORK PERFORMED (not subject to overtime premiums):

- Pile Driving apprentices shall receive \$0.25 per hour when performing piledriving work.
- Certified welders shall receive \$1.00 per hour over the apprentices rate of pay when the apprentice is required to be certified and performs DOT or ABS specified welding work
- When an apprentice performs work within a contaminated area on a State and/or Federally designated hazardous waste site, and where relevant State and/or Federal regulations require the apprentice to be furnished and use or wear required forms of personal protection, then the apprentice shall receive his regular hourly rate plus \$1.50 per hour.

2-291B-Cli

Carpenter - Building / Heavy&Highway

12/01/2018

JOB DESCRIPTION Carpenter - Building / Heavy&Highway

DISTRICT 2

ENTIRE COUNTIES

Albany, Allegany, Broome, Cattaraugus, Cayuga, Chautauqua, Chemung, Chenango, Clinton, Columbia, Cortland, Delaware, Erie, Essex, Franklin, Fulton, Genesee, Greene, Hamilton, Herkimer, Jefferson, Lewis, Livingston, Madison, Monroe, Montgomery, Niagara, Oneida, Onondaga, Ontario, Orleans, Oswego, Otsego, Rensselaer, Saratoga, Schenectady, Schoharie, Schuyler, Seneca, St. Lawrence, Steuben, Sullivan, Tioga, Tompkins, Ulster, Warren, Washington, Wayne, Wyoming, Yates

PARTIAL COUNTIES

Orange: The area lying on Northern side of Orange County demarcated by a line drawn from the Bear Mountain Bridge continuing east to the Bear Mountain Circle, continue North on 9W to the town of Cornwall where County Road 107 (also known as Quaker Rd) crosses under 9W, then east on County Road 107 to Route 32, then north on Route 32 to Orrs Mills Rd, then west on Orrs Mills Rd to Route 94, continue west and south on Route 94 to the Town of Chester, to the intersection of Kings Highway, continue south on Kings Highway to Bellvale Rd, west on Bellvale Rd to Bellvale Lakes Rd, then south on Bellvale Lakes Rd to Kain Rd, southeast on Kain Rd to Route 17A, then north and southeast along Route 17A to Route 210, then follow Route 210 to NJ Border.

WAGES

Wages per hour: 07/01/2018

Carpenter - ONLY for
Artificial Turf/Synthetic
Sport Surface

\$ 30.40

Note - Does not include the operation of equipment. Please see Operating Engineers rates.

SUPPLEMENTAL BENEFITS

Per hour:

Journeyman \$ 22.43

OVERTIME PAY

See (B, E, Q, X) on OVERTIME PAGE

HOLIDAY

Paid: See (2, 17) on HOLIDAY PAGE
Overtime: See (5, 6, 16) on HOLIDAY PAGE

Notes:

When a holiday falls upon a Saturday, it shall be observed on the preceding Friday. When a holiday falls upon a Sunday, it shall be observed on the following Monday.

An employee taking an unexcused day off the regularly scheduled day before or after a paid Holiday shall not receive Holiday pay.

REGISTERED APPRENTICES

Wages per hour:

One year terms at the following percentage of Journeyman's wage:

1st	2nd	3rd	4th
50%	60%	70%	80%

Supplemental Benefits per hour:

1st year term	\$ 11.15
2nd year term	11.15
3rd year term	13.75
4th year term	13.75

2-42AtSS

Carpenter - Heavy&Highway

12/01/2018

JOB DESCRIPTION Carpenter - Heavy&Highway

DISTRICT 2

ENTIRE COUNTIES

Albany, Clinton, Essex, Franklin, Fulton, Greene, Hamilton, Montgomery, Rensselaer, Saratoga, Schenectady, Schoharie, Warren, Washington

WAGES

Per hour 07/01/2018

Carpenter	\$ 31.48
Piledriver	31.48
Diver-Wet Day	56.48
Diver-Dry Day	32.48
Diver-Tender	32.48

NOTE ADDITIONAL AMOUNTS PAID FOR THE FOLLOWING WORK LISTED BELOW (not subject to overtime premiums):

- When Heavy & Highway Millwright work is performed, the employee will receive an additional \$1.50 per hour for all hours worked (Rate effective till 4/30/19, on 5/1/19 refer to Millwright rate schedule for Heavy & Highway work).
- When project owner mandates a single irregular work shift, the employee will receive an additional \$2.00 per hour. A single irregular work shift can start any time from 5:00 p.m. to 1:00 a.m.
- State or Federal designated hazardous site, requiring protective gear shall be an additional \$2.00 per hour.
- Certified welders when required to perform welding work will receive an additional \$1.50 per hour.

ADDITIONAL NOTES PERTAINING TO DIVERS/TENDERS:

- Divers and Tenders shall receive one and one half (1 1/2) times their regular diver and tender rate of pay for Effluent and Slurry diving.
- Divers and tenders being paid at the specified rate for Effluent and Slurry diving shall have all overtime rates based on the specified rate plus the appropriate overtime rates (one and one half or two times the specified rate for Slurry and Effluent divers and tenders).
- The pilot of an ADS or submersible will receive one and one-half (1 1/2) times the Diver-Wet Day Rate for time submerged.
- Depth pay for Divers based upon deepest depth on the day of the dive:
 - 0' to 50' no additional fee
 - 51'to 100' additional \$.50 per foot
 - 101'to 150' additional \$0.75 per foot
 - 151'and deeper additional \$1.25 per foot
- Penetration pay for Divers based upon deepest penetration on the day of the dive:
 - 0' to 50' no additional fee
 - 51' to 100' additional \$.75 per foot
 - 101' and deeper additional \$1.00 per foot
- Diver rates applies to all hours worked on dive day.

Four (4), ten (10) hour days may be worked at straight time during a week, Monday thru Friday, provided the project duration is more than forty (40) hours.

NOTE - In order to use the '4 Day/10 Hour Work schedule', as your normal schedule, you must submit an 'Employer Registration for Use of 4 Day/10 Hour Work Schedule,' form PW30.1; and there must be a dispensation of hours in place on the project. If the PW30.1 is not submitted you may be liable for overtime payments for work over 8 hours per day.

SUPPLEMENTAL BENEFITS

Per hour:

Journeyman \$ 21.35

OVERTIME PAY

See (B, E, Q, X) on OVERTIME PAGE

HOLIDAY

Paid: See (2, 17) on HOLIDAY PAGE

Overtime: See (5, 6) on HOLIDAY PAGE

In the event a Holiday falls on a Saturday, the Friday before will be observed as a Holiday. If a Holiday falls on a Sunday, then Monday will be observed as a Holiday.

REGISTERED APPRENTICES

Wages per hour

FOR APPRENTICES INDENTURED PRIOR TO JANUARY 1, 2016

One year terms at the following percentage of Journeyman's base wage

1st	2nd	3rd	4th
50%	60%	70%	80%

Supplemental Benefits per hour:

1st year term	\$ 11.02
2nd year term	11.02
3rd year term	13.62
4th year term	13.62

FOR APPRENTICES INDENTURED AFTER JANUARY 1, 2016

1,300 hour terms at the following percentage of Journeyman's base wage

1st	2nd	3rd	4th	5th
50%	60%	65%	70%	80%

Supplemental Benefits per hour:

1st term	\$ 11.02
2nd term	11.02
3rd term	13.62
4th term	13.62
5th term	13.62

NOTE ADDITIONAL AMOUNTS PAID TO APPRENTICES FOR THE FOLLOWING WORK LISTED BELOW (not subject to overtime premiums):

- When Heavy & Highway Millwright work is performed, the employee will receive an additional \$1.50 per hour for all hours worked (Rate effective till 4/30/19, on 5/1/19 refer to Millwright rate schedule for Heavy & Highway work).
- When project owner mandates a single irregular work shift, the employee will receive an additional \$2.00 per hour. A single irregular work shift can start any time from 5:00 p.m. to 1:00 a.m.
- State or Federal designated hazardous site, requiring protective gear shall be an additional \$2.00 per hour.
- Certified welders when required to perform welding work will receive an additional \$1.50 per hour.

2-291HH-Alb

Electrician

12/01/2018

JOB DESCRIPTION Electrician

DISTRICT 6

ENTIRE COUNTIES

Clinton, Essex, Franklin, Jefferson, Lewis, St. Lawrence

WAGES

Per hour:	07/01/2018	04/01/2019 Additional	04/01/2020 Additional	04/01/2021 Additional
Electrician	\$ 34.50	\$ 1.50	\$ 1.55	\$ 1.60
Teledata	34.50			
Welder	36.50			

NOTE: Additional premiums for the following work listed:

- Additional \$1.50 per hour for work performed underground such as tunnels and mine shafts. Excludes manholes and walkway tunnels between buildings.
- Additional \$1.50 per hour for working 35 feet or more on scaffolds, ladders, towers, steeples, structural steel, or mechanical lifts over 65 feet.

Shift Work: The following rates will apply on all Contracting Agency mandated shifts worked between the hours listed below. The employer may be permitted to adjust the starting hours of the shift by up to two (2) hours if required by the agency. If a shift begins outside of the stated shift hours, the rate paid would be determined by what shift the majority of the hours were worked.

- 1st shift: 8:00 AM to 4:30 PM regular wage rate
- 2nd shift: 4:30 PM to 1:00 AM regular wage rate plus 17.3%
- 3rd shift: 12:30 AM to 9:00 AM regular wage rate plus 31.4%

** IMPORTANT NOTICE - EFFECTIVE 07/01/2012 **

Four (4), ten (10) hour days may be worked at straight time during a week, Monday thru Thursday. Friday may be used as a make-up day. NOTE - In order to use the '4 Day/10 Hour Work schedule', as your normal schedule, you must submit an 'Employer Registration for Use of 4 Day/10 Hour Work Schedule,' form PW30.1; and there must be a dispensation of hours in place on the project. If the PW30.1 is not submitted you may be liable for overtime payments for work over 8 hours per day.

SUPPLEMENTAL BENEFITS

Per hour:
 \$ 19.68
 * plus 5.75% of
 gross wage

* NOTE: THE 5.75% IS BASED ON THE HOURLY WAGE PAID, STRAIGHT TIME RATE OR PREMIUM TIME RATE.

OVERTIME PAY

See (B, E, Q) on OVERTIME PAGE

NOTE: WAGE CAP...Double the straight time hourly base wage shall be the maximum hourly wage compensation for any hour worked. Contractor is still responsible to pay the hourly benefit amount for each hour worked.

HOLIDAY

Paid: See (1) on HOLIDAY PAGE
 Overtime: See (5, 6) on HOLIDAY PAGE

REGISTERED APPRENTICES

WAGES: Hourly terms at the following percentage of Journeyman's wage.

	1-1000	to 2000	to 3500	to 5000	to 6500	to 8000
	45%	50%	55%	60%	70%	80%
Electrician	\$15.52	\$17.25	\$18.97	\$20.70	\$24.15	\$27.60
Tunnel	\$17.02	\$18.75	\$20.47	\$22.20	\$25.65	\$29.10

SUPPLEMENTAL BENEFITS per hour:

Appr 1st & 2nd term \$ 9.37
 * plus 5.75% of

gross wage

Appr All other terms \$ 19.68
 * plus 5.75% of
 gross wage

* NOTE: THE 5.75% IS BASED ON THE HOURLY WAGE PAID, STRAIGHT TIME RATE OR PREMIUM TIME RATE.

6-910

Elevator Constructor **12/01/2018**

JOB DESCRIPTION Elevator Constructor

DISTRICT 1

ENTIRE COUNTIES

Albany, Clinton, Essex, Fulton, Hamilton, Herkimer, Montgomery, Otsego, Rensselaer, Saratoga, Schenectady, Schoharie, Warren, Washington

PARTIAL COUNTIES

Madison: Madison Only the towns of: Brookfield, Hamilton, Lincoln, Madison, Smithfield, Stockbridge and the City of Oneida
 Oneida: Entire county except the towns of: Camden, Florence, and Vienna.

WAGES

Per hour

	07/01/2018	01/01/2019
--	------------	------------

Mechanic	\$ 44.58	\$ 46.00
----------	----------	----------

Helper	70% of Mechanic Wage Rate	70% of Mechanic Wage Rate
--------	------------------------------	------------------------------

Four (4), ten (10) hour days may be worked at straight time during a week, Monday thru Thursday or Tuesday thru Friday.

NOTE - In order to use the "4 Day/10 Hour Work schedule", as your normal schedule, you must submit an "Employer Registration for Use of 4 Day/10 Hour Work Schedule," form PW30.1; and there must be a dispensation of hours in place on the project. If the PW30.1 is not submitted you may be liable for overtime payments for work over 8 hours per day.

SUPPLEMENTAL BENEFITS

Per hour

	07/01/2018	01/01/2019
--	------------	------------

Journeyman/Helper	\$ 32.645*	\$ 33.705*
-------------------	------------	------------

(*)Plus 6% of hourly rate, if less than 5 years of service. Plus 8% of hourly rate, if more than 5 years of service.

OVERTIME PAY

See (D, O) on OVERTIME PAGE

HOLIDAY

Paid: See (5, 6, 15, 16) on HOLIDAY PAGE

Overtime: See (5, 6, 15, 16) on HOLIDAY PAGE

Note: When a paid holiday falls on Saturday, it shall be observed on Friday. When a paid holiday falls on Sunday, it shall be observed on Monday.

REGISTERED APPRENTICES

Wages per hour:

0-6 mo*	6-12 mo	2nd yr	3rd yr	4th yr
50%	55 %	65 %	70 %	80 %

(*)Plus 6% of the hourly rate, no additional supplemental benefits.

Supplemental Benefits - per hour worked:

Same as Journeyman/Helper

1-35

Glazier **12/01/2018**

JOB DESCRIPTION Glazier

DISTRICT 1

ENTIRE COUNTIES

Albany, Clinton, Columbia, Essex, Franklin, Fulton, Greene, Hamilton, Montgomery, Rensselaer, Saratoga, Schenectady, Schoharie, Warren, Washington

WAGES

Per hour

07/01/2018

Glazier base wage \$ 27.65
 + additional \$2.20 per hour for all hours worked

*High Work Base Wage 31.00
 + additional \$3.52 per hour for all hours worked

(*)When working on Swing Stage or Lift 100 feet or more in height, measured from the ground level up.

Four (4), ten (10) hour days may be worked at straight time during a week, Monday thru Thursday. Friday may be used as a make-up day.
 NOTE - In order to use the '4 Day/10 Hour Work schedule', as your normal schedule, you must submit an 'Employer Registration for Use of 4 Day/10 Hour Work Schedule,' form PW30.1; and there must be a dispensation of hours in place on the project. If the PW30.1 is not submitted you may be liable for overtime payments for work over 8 hours per day.

SUPPLEMENTAL BENEFITS

Per hour

Journeyman \$ 19.81
 Journeyman
 High Work 24.69

OVERTIME PAY

See (B, E, E2, Q) on OVERTIME PAGE
 Premium is applied to the respective base wage only.

HOLIDAY

Paid: See (1) on HOLIDAY PAGE
 Overtime: See (5, 6) on HOLIDAY PAGE

Note: If any of the holidays are designated by federal law to be celebrated on a day other than that on which they regularly fall, then the holiday shall be celebrated on the day set by said federal law as if the day on which the holiday is celebrated was actually the holiday date.

REGISTERED APPRENTICES

Wages per hour

Apprentice Glazier One Year and 1500 hr. terms at the following percentage of Journeyman's base wage.

1st	2nd	3rd	4th
50%	65%	75%	90%

+ additional \$2.20 per hour for all hours worked for all terms

Apprentice Glazier Hi-Work One Year and 1500 hr. terms at the following percentage of Journeyman's Hi-Work base wage.

1st	2nd	3rd	4th
50%	65%	75%	90%

+ additional \$3.52 per hour for all hours worked for all terms

Supplemental Benefits per hour worked

Apprentice	
1st-2nd term	\$ 16.14
3rd-4th term	19.81
Apprentice High Work	
1st-2nd term	18.69
3rd-4th term	24.69

1-201

Insulator - Heat & Frost

12/01/2018

JOB DESCRIPTION Insulator - Heat & Frost

DISTRICT 1

ENTIRE COUNTIES

Albany, Columbia, Delaware, Essex, Fulton, Greene, Hamilton, Montgomery, Rensselaer, Saratoga, Schenectady, Schoharie, Sullivan, Ulster, Warren, Washington

WAGES

Wages per hour 07/01/2018

Asbestos Worker*	\$ 34.90
Insulator*	34.90
Firestopping Worker*	29.67

(*)On Mechanical Systems only.

On government mandated shift work additional 12% of wage for all shifts starting after 3:30 P.M.

SUPPLEMENTAL BENEFITS

Per hour

Journeyman \$ 21.94

OVERTIME PAY

See (*B1, **Q) on OVERTIME PAGE

*B1=Double time begins after 10 hours on Saturday

**Q=Triple time on Labor Day if worked.

HOLIDAY

Paid: See (1) on HOLIDAY PAGE

Overtime: See (5, 6) on HOLIDAY PAGE

When a holiday falls on Sunday the following Monday shall be observed as the holiday.

REGISTERED APPRENTICES

Wages per hour

one year terms at the following percentage of Journeyman's wage.

1st	2nd	3rd	4th
60 %	70 %	80 %	90 %

Supplemental Benefits per hour worked:

Apprentices \$ 21.94

1-40

Ironworker

12/01/2018

JOB DESCRIPTION Ironworker

DISTRICT 1

ENTIRE COUNTIES

Albany, Clinton, Columbia, Delaware, Essex, Greene, Rensselaer, Saratoga, Schenectady, Schoharie, Warren, Washington

PARTIAL COUNTIES

Fulton: Only the Townships of Broadalbin, Mayfield, Northampton, Perth, Bleecker and Johnstown.

Hamilton: Only the Townships of Hope, Benson and Wells.

Montgomery: Only the Townships of Florida, Amsterdam, Charleston, Glen, Mohawk and Root.

Otsego: Only the Towns of Unadilla, Butternuts, Morris, Otego, Oneonta, Laurens, Millford, Maryland and Worcester.

WAGES

Wages 07/01/2018
Per hour

Ornamental	\$ 31.00
Reinforcing	31.00
Rodman	31.00
Structural & Precast	31.00
Mover/Rigger	31.00
Fence Erector	31.00
Stone Derrickman	31.00
Sheeter	31.25
Curtain Wall Installer	31.00
Metal Window Installer	31.00

SUPPLEMENTAL BENEFITS

Per hour

JOURNEYMAN \$ 28.11

OVERTIME PAY

See (B, E, Q) on OVERTIME PAGE

HOLIDAY

Paid: See (1) on HOLIDAY PAGE

Overtime: See (5, 6) on HOLIDAY PAGE

Note: Any holiday which occurs on Sunday shall be observed the following Monday.

REGISTERED APPRENTICES

Wages per hour
 ONE YEAR TERMS AT THE FOLLOWING WAGE RATES:

	07/01/2018
1st year	\$ 16.50
2nd year	18.50
3rd year	20.50
4th year	22.50
Supplemental Benefits per hour worked	
1st year	\$ 11.00
2nd year	21.86
3rd year	23.40
4th year	24.96

1-12

Laborer - Building **12/01/2018**

JOB DESCRIPTION Laborer - Building **DISTRICT 7**

ENTIRE COUNTIES
 Clinton, Essex, Warren

WAGES

GROUP #A: All Laborers (except as noted)

GROUP #B: Asbestos & Hazardous Waste Work.

WAGES per hour	07/01/2018	07/01/2019
Group # A	\$ 23.68	Additional \$ 1.50
Group # B	25.18	1.50

SUPPLEMENTAL BENEFITS

Per hour:

Journeyman \$ 21.60

OVERTIME PAY

See (B, E, E2, Q) on OVERTIME PAGE

HOLIDAY

Paid: See (1) on HOLIDAY PAGE
 Overtime: See (5, 6) on HOLIDAY PAGE

REGISTERED APPRENTICES

Wages per hour

Terms are at the following percentage of Group Rate A.

0-1,000 Hrs	1,001-2,000 Hrs	2,001-3,000 Hrs	3,001-4,000 Hrs
60%	70%	80%	90%

SUPPLEMENTAL BENEFITS per hour worked:

All Terms: Same as Journeyman

7-1822ew

Laborer - Heavy&Highway **12/01/2018**

JOB DESCRIPTION Laborer - Heavy&Highway **DISTRICT 7**

ENTIRE COUNTIES
 Clinton, Essex, Warren

WAGES

Per hour:

GROUP A: Drill Helper, Flagmen, Outboard and Hand Boats.

GROUP B: BASIC RATE: Bull Float (where used for strike off only), Chain Saw, Concrete Aggregate Bin, Concrete Bootman, Gin Buggy, Hand or Machine Vibrator, Jack Hammer, Mason Tender, Mortar Mixer, Pavement Breaker, Handlers of All Steel Mesh, Small Generators for Laborers' Tools, Installation of Bridge Drainage Pipe, Pipe Layers, Vibrator Type Rollers, Tamper, Drill Doctor, Water Pump Operator (1-1/2" and Single Diaphragm) Nozzle (Asphalt, Guniting, Seeding, and Sand Blasting), Laborers on Chain Link Fence Erection, Rock Splitter & Power Unit, Pusher Type Concrete Saw and All Other Gas, Electric, Oil, and Air Tool Operators, Wrecking Laborer.

GROUP C: Drilling Equipment - only where a separate air compressor unit supplies power, Acetylene Torch Operators, Asphalt Raker, Powder Man, Tail or Screw Operator on Asphalt Paver.

GROUP D: Blasters, Form Setters, Stone or Granite Curb Setters.

GROUP E: Hazardous Waste Removal Work when designated by State/Federal as hazardous waste site and regulations require employees wear required personal protection.

WAGES per hour 07/01/2018

Group # A	\$ 25.47
Group # B	25.67
Group # C	25.87
Group # D	26.07
Group # E	27.67

NOTE: A single irregular work shift starting any time between 5:00 PM and 1:00 AM on governmental mandated night work shall be paid an additional \$2.00 per hour.

IMPORTANT NOTE: Operation of equipment (i.e. forklift, skid steer) is the work of the Operating Engineers, please see appropriate rates.

SUPPLEMENTAL BENEFITS

Per hour:

Journeyman \$ 23.85

OVERTIME PAY

See (B, E, Q) on OVERTIME PAGE

HOLIDAY

Paid: See (5, 6) on HOLIDAY PAGE

Overtime: See (5, 6) on HOLIDAY PAGE

NOTE: If a holiday falls on Sunday, it will be celebrated on Monday. In the event that men work on this Sunday holiday, they shall be paid double time. In the event that men work on Monday, they shall be compensated at double time plus the holiday pay. Accordingly, the Monday following the Sunday is treated as the holiday.

REGISTERED APPRENTICES

WAGES: 1000 hour terms at the following percentage of Journeyman's wage.

1st	2nd	3rd	4th
60%	70%	80%	90%

SUPPLEMENTAL BENEFITS per hour worked:

All Terms: Same as Journeyman

7-1822/2h

Laborer - Tunnel

12/01/2018

JOB DESCRIPTION Laborer - Tunnel

DISTRICT 7

ENTIRE COUNTIES

Clinton, Essex, Warren

WAGES

GROUP A: General Laborer

GROUP B: Change Houseman, Miners and all Machine Men, Safety Miner, all Shaft-work, Caisson work, Drilling, Blow Pipe, all Air Tools, Tugger, Scaling, Nipper, Guniting pot to nozzle, Bit Grinder, Signal Man (top and bottom), Concrete Men, Shield driven tunnels, mixed face and soft ground, liner plate tunnels in free air.

GROUP C: Hazardous/Waste Work

WAGES (per hour)

07/01/2018

Tunnel Laborer:

Group A	\$ 28.65
Group B	28.85
Group C*	30.65

(*)Work site required to be designated by State/Federal as hazardous waste site and relevant regulations require employees to use personal protection.

SUPPLEMENTAL BENEFITS

Per hour:

Journeyman	\$ 23.85
------------	----------

OVERTIME PAY

See (B, E, Q) on OVERTIME PAGE

HOLIDAY

Paid: See (5, 6) on HOLIDAY PAGE

Overtime: See (5, 6) on HOLIDAY PAGE

NOTE: If a holiday falls on Saturday, it will be celebrated on Friday. If a holiday falls on Sunday, it will be celebrated on Monday. In the event that men work on this Sunday holiday, they shall be paid double time. In the event that men work on Monday, they shall be compensated at double time plus the holiday pay. Accordingly, the Monday following the Sunday is treated as the holiday.

REGISTERED APPRENTICES

Wages per hour

Terms are at the following percentage of Group B rate.

0-1000 Hrs	1001-2000 Hrs	2001-3000 Hrs	3001-4000 Hrs
60%	70%	80%	90%

SUPPLEMENTAL BENEFITS

All Terms: Same as Journeyman

7-1822T

Lineman Electrician

12/01/2018

JOB DESCRIPTION Lineman Electrician

DISTRICT 6

ENTIRE COUNTIES

Albany, Allegany, Broome, Cattaraugus, Cayuga, Chautauqua, Chemung, Chenango, Clinton, Columbia, Cortland, Delaware, Dutchess, Erie, Essex, Franklin, Fulton, Genesee, Greene, Hamilton, Herkimer, Jefferson, Lewis, Livingston, Madison, Monroe, Montgomery, Niagara, Oneida, Onondaga, Ontario, Orange, Orleans, Oswego, Otsego, Putnam, Rensselaer, Rockland, Saratoga, Schenectady, Schoharie, Schuyler, Seneca, St. Lawrence, Steuben, Sullivan, Tioga, Tompkins, Ulster, Warren, Washington, Wayne, Wyoming, Yates

WAGES

Per hour:

NOTE: Includes Teledata Work within ten (10) feet of High Voltage Transmission Lines

Below rates applicable on all overhead and underground distribution and maintenance work, and all overhead and underground transmission line work and the installation of fiber optic cable where no other construction trades are or have been involved. (Ref #14.01.01)

	07/01/2018	05/06/2019	05/04/2020
Lineman, Technician	\$ 50.60	\$ 52.05	\$ 53.50
Crane, Crawler Backhoe	50.60	52.05	53.50
Welder, Cable Splicer	50.60	52.05	53.50
Digging Mach. Operator	45.54	46.85	48.15
Tractor Trailer Driver	43.01	44.24	45.48
Groundman, Truck Driver	40.48	41.64	42.80
Equipment Mechanic	40.48	41.64	42.80
Flagman	30.36	31.23	32.10

Additional \$1.00 per hour for entire crew when a helicopter is used.

Below rates applicable on all electrical sub-stations, switching structures, fiber optic cable and all other work not defined as "Utility outside electrical work". (Ref #14.02.01-A)

	07/01/2018	05/06/2019	05/04/2020
Lineman, Technician	\$ 50.60	\$ 52.05	\$ 53.50
Crane, Crawler Backhoe	50.60	52.05	53.50
Cable Splicer	55.66	57.26	58.85

Certified Welder - Pipe Type Cable	53.13	54.65	56.18
Digging Mach. Operator	45.54	46.85	48.15
Tractor Trailer Driver	43.01	44.24	45.48
Groundman, Truck Driver	40.48	41.64	42.80
Equipment Mechanic	40.48	41.64	42.80
Flagman	30.36	31.23	32.10

Additional \$1.00 per hour for entire crew when a helicopter is used.

Below rates apply on switching structures, maintenance projects, railroad catenary install/maintenance third rail installation, bonding of rails and pipe type cable and installation of fiber optic cable. (Ref #14.02.01-B)

Lineman, Tech, Welder	\$ 51.92	\$ 53.37	\$ 54.82
Crane, Crawler Backhoe	51.92	53.37	54.82
Cable Splicer	57.11	58.71	60.30
Certified Welder - Pipe Type Cable	54.52	56.04	57.56
Digging Mach. Operator	46.73	48.03	49.34
Tractor Trailer Driver	44.13	45.36	46.60
Groundman, Truck Driver	41.54	42.70	43.86
Equipment Mechanic	41.54	42.70	43.86
Flagman	31.15	32.02	32.89

Additional \$1.00 per hour for entire crew when a helicopter is used.

Below rates applicable on all overhead and underground transmission line work & fiber optic cable where other construction trades are or have been involved. This applies to transmission line work only, not other construction. (Ref #14.03.01)

Lineman, Tech, Welder	\$ 53.11	\$ 54.56	\$ 56.01
Crane, Crawler Backhoe	53.11	54.56	56.01
Cable Splicer	53.11	54.56	56.01
Digging Mach. Operator	47.80	49.10	50.41
Tractor Trailer Driver	45.14	46.38	47.61
Groundman, Truck Driver	42.49	43.65	44.81
Equipment Mechanic	42.49	43.65	44.81
Flagman	31.87	32.74	33.61

Additional \$1.00 per hour for entire crew when a helicopter is used.

NOTE: THE FOLLOWING RATES WILL APPLY ON ALL CONTRACTING AGENCY MANDATED MULTIPLE SHIFTS OF AT LEAST FIVE (5) DAYS DURATION WORKED BETWEEN THE HOURS LISTED BELOW:

1ST SHIFT	8:00 AM to 4:30 PM REGULAR RATE
2ND SHIFT	4:30 PM to 1:00 AM REGULAR RATE PLUS 17.3 %
3RD SHIFT	12:30 AM to 9:00 AM REGULAR RATE PLUS 31.4 %

**** IMPORTANT NOTICE ****

Four (4), ten (10) hour days may be worked at straight time during a week, Monday thru Thursday. Friday may be used as a make-up day.

*Effective 05/06/2013, Tuesday thru Friday may be worked with no make-up day.

NOTE - In order to use the '4 Day/10 Hour Work schedule', as your normal schedule, you must submit an 'Employer Registration for Use of 4 Day/10 Hour Work Schedule,' form PW30.1; and there must be a dispensation of hours in place on the project. If the PW30.1 is not submitted you may be liable for overtime payments for work over 8 hours per day.

SUPPLEMENTAL BENEFITS

Per hour worked (also required on non-worked holidays):

The following SUPPLEMENTAL BENEFITS apply to all classification categories of CONSTRUCTION, TRANSMISSION and DISTRIBUTION.

Journeyman	\$ 23.40 *plus 6.75% of hourly wage	\$ 24.15 *plus 6.75% of hourly wage	\$ 24.90 *plus 6.75% of hourly wage
------------	---	---	---

*The 6.75% is based on the hourly wage paid, straight time rate or premium rate.

OVERTIME PAY

See (B, E, Q,) on OVERTIME PAGE. *Note* Double time for all emergency work designated by the Dept. of Jurisdiction.
 NOTE: WAGE CAP...Double the straight time hourly base wage shall be the maximum hourly wage compensation for any hour worked.
 Contractor is still responsible to pay the hourly benefit amount for each hour worked.

HOLIDAY

Paid See (5, 6, 8, 13, 25) on HOLIDAY PAGE plus Governor of NYS Election Day.
 Overtime See (5, 6, 8, 13, 25) on HOLIDAY PAGE plus Governor of NYS Election Day.

NOTE: All paid holidays falling on Saturday shall be observed on the preceding Friday. All paid holidays falling on Sunday shall be observed on the following Monday. Supplements for holidays paid at straight time.

REGISTERED APPRENTICES

WAGES: 1000 hour terms at the following percentage of the applicable Journeyman Lineman wage.

1st	2nd	3rd	4th	5th	6th	7th
60%	65%	70%	75%	80%	85%	90%

SUPPLEMENTAL BENEFITS: Same as Journeyman

6-1249a

Lineman Electrician - Teledata

12/01/2018

JOB DESCRIPTION Lineman Electrician - Teledata

DISTRICT 6

ENTIRE COUNTIES

Albany, Allegany, Broome, Cattaraugus, Cayuga, Chautauqua, Chemung, Chenango, Clinton, Columbia, Cortland, Delaware, Dutchess, Erie, Essex, Franklin, Fulton, Genesee, Greene, Hamilton, Herkimer, Jefferson, Lewis, Livingston, Madison, Monroe, Montgomery, Niagara, Oneida, Onondaga, Ontario, Orange, Orleans, Oswego, Otsego, Putnam, Rensselaer, Rockland, Saratoga, Schenectady, Schoharie, Schuyler, Seneca, St. Lawrence, Steuben, Sullivan, Tioga, Tompkins, Ulster, Warren, Washington, Wayne, Westchester, Wyoming, Yates

WAGES

Per hour:

For outside work, stopping at first point of attachment (demarcation).

	07/01/2018	01/01/2019	01/01/2020	01/01/2021
Cable Splicer	\$ 31.83	\$ 32.78	\$ 33.77	\$ 34.78
Installer, Repairman	30.21	\$ 31.12	\$ 32.05	\$ 33.01
Teledata Lineman	30.21	\$ 31.12	\$ 32.05	\$ 33.01
Tech., Equip. Operator	30.21	\$ 31.12	\$ 32.05	\$ 33.01
Groundman	16.01	\$ 16.49	\$ 16.99	\$ 17.50

NOTE: EXCLUDES Teledata work within ten (10) feet of High Voltage (600 volts and over) transmission lines. For this work please see LINEMAN.

NOTE: THE FOLLOWING RATES WILL APPLY ON ALL CONTRACTING AGENCY MANDATED MULTIPLE SHIFTS OF AT LEAST FIVE (5) DAYS DURATION WORKED:

1ST SHIFT	REGULAR RATE
2ND SHIFT	REGULAR RATE PLUS 10%
3RD SHIFT	REGULAR RATE PLUS 15%

SUPPLEMENTAL BENEFITS

Per hour:

Journeyman	\$ 4.73	\$ 4.73	\$ 4.73	\$ 4.73
	*plus 3% of wage paid	*plus 3% of wage paid	*plus 3% of wage paid	*plus 3% of wage paid

*The 3% is based on the hourly wage paid, straight time rate or premium rate.

OVERTIME PAY

See (B, E, Q) on OVERTIME PAGE

NOTE: WAGE CAP...Double the straight time hourly base wage shall be the maximum hourly wage compensation for any hour worked.
 Contractor is still responsible to pay the hourly benefit amount for each hour worked.

HOLIDAY

Paid: See (1) on HOLIDAY PAGE
 Overtime: See (5, 6, 16) on HOLIDAY PAGE

6-1249LT - Teledata

Lineman Electrician - Traffic Signal, Lighting **12/01/2018**

JOB DESCRIPTION Lineman Electrician - Traffic Signal, Lighting

DISTRICT 6

ENTIRE COUNTIES

Albany, Allegany, Broome, Cattaraugus, Cayuga, Chautauqua, Chemung, Chenango, Clinton, Cortland, Delaware, Erie, Essex, Franklin, Fulton, Genesee, Greene, Hamilton, Herkimer, Jefferson, Lewis, Livingston, Madison, Monroe, Montgomery, Niagara, Oneida, Onondaga, Ontario, Orleans, Oswego, Otsego, Rensselaer, Saratoga, Schoharie, Schoharie, Schuylar, Seneca, St. Lawrence, Steuben, Sullivan, Tioga, Tompkins, Warren, Washington, Wayne, Wyoming, Yates

WAGES

Lineman/Technician shall perform all overhead aerial work. A Lineman/Technician on the ground will install all electrical panels, connect all grounds, install and connect all electrical conductors which includes, but is not limited to road loop wires; conduit and plastic or other type pipes that carry conductors, flex cables and connectors, and to oversee the encasement or burial of such conduits or pipes.

A Groundman/Groundman Truck Driver shall: Build and set concrete forms, handle steel mesh, set footer cages, transport concrete in a wheelbarrow, hand or machine concrete vibrator, finish concrete footers, mix mortar, grout pole bases, cover and maintain footers while curing in cold weather, operate jack hammer, operate hand pavement breaker, tamper, concrete and other motorized saws, as a drill helper, operate and maintain generators, water pumps, chainsaws, sand blasting, operate mulching and seeding machine, air tools, electric tools, gas tools, load and unload materials, hand shovel and/or broom, prepare and pour mastic and other fillers, assist digger operator equipment operator in ground excavation and restoration, landscape work and painting. Only when assisting a lineman technician, a groundman/groundman truck driver may assist in installing conduit, pipe, cables and equipment.

A flagger's duties shall consist of traffic control only.
 (Ref #14.01.01)

Per hour:

	07/01/2018	05/06/2019	05/04/2020
Lineman, Technician	\$ 43.80	\$ 45.00	\$ 46.20
Crane, Crawler Backhoe	43.80	45.00	46.20
Certified Welder	45.99	47.25	48.51
Digging Machine	39.42	40.50	41.58
Tractor Trailer Driver	37.23	38.25	39.27
Groundman, Truck Driver	35.04	36.00	36.96
Equipment Mechanic	35.04	36.00	36.96
Flagman	26.28	27.00	27.72

Above rates applicable on all Lighting and Traffic Signal Systems with the installation, testing, operation, maintenance and repair of all traffic control and illumination projects, traffic monitoring systems, road weather information systems and the installation of Fiber Optic Cable.

NOTE: THE FOLLOWING RATES WILL APPLY ON ALL CONTRACTING AGENCY MANDATED MULTIPLE SHIFTS OF AT LEAST FIVE (5) DAYS DURATION WORKED BETWEEN THE HOURS LISTED BELOW:

1ST SHIFT	8:00 AM TO 4:30 PM	REGULAR RATE
2ND SHIFT	4:30 PM TO 1:00 AM	REGULAR RATE PLUS 17.3%
3RD SHIFT	12:30 AM TO 9:00 AM	REGULAR RATE PLUS 31.4%

**** IMPORTANT NOTICE ****

Four (4), ten (10) hour days may be worked at straight time during a week, Monday thru Thursday. Friday may be used as a make-up day.
 *Effective 05/06/2013, Tuesday thru Friday may be worked with no make-up day.

NOTE - In order to use the '4 Day/10 Hour Work schedule', as your normal schedule, you must submit an 'Employer Registration for Use of 4 Day/10 Hour Work Schedule,' form PW30.1; and there must be a dispensation of hours in place on the project. If the PW30.1 is not submitted you may be liable for overtime payments for work over 8 hours per day.

SUPPLEMENTAL BENEFITS

Per hour worked (but also required on non-worked holidays):

Journeyman	\$ 23.40	\$ 24.15	\$ 24.90
	*plus 6.75% of hourly wage	*plus 6.75% of hourly wage	*plus 6.75% of hourly wage

*The 6.75% is based on the hourly wage paid, straight time rate or premium rate.
 Supplements paid at STRAIGHT TIME rate for holidays.

OVERTIME PAY

See (B, E, Q) on OVERTIME PAGE. *Note* Double time for all emergency work designated by the Dept. of Jurisdiction.

NOTE: WAGE CAP...Double the straight time hourly base wage shall be the maximum hourly wage compensation for any hour worked.
 Contractor is still responsible to pay the hourly benefit amount for each hour worked.

HOLIDAY

Paid: See (5, 6, 8, 13, 25) on HOLIDAY PAGE plus Governor of NYS Election Day.
 Overtime: See (5, 6, 8, 13, 25) on HOLIDAY PAGE plus Governor of NYS Election Day.

NOTE: All paid holidays falling on Saturday shall be observed on the preceding Friday. All paid holidays falling on Sunday shall be observed on the following Monday. Supplements for holidays paid at straight time.

REGISTERED APPRENTICES

WAGES: Per hour. 1000 hour terms.

	07/01/2018	05/06/2019	05/04/2020
1st term	\$ 26.28	\$ 27.00	\$ 27.72
2nd term	28.47	29.25	30.03
3rd term	30.66	31.50	32.34
4th term	32.85	33.75	34.65
5th term	35.04	36.00	36.96
6th term	37.23	38.25	39.27
7th term	39.42	40.50	41.58

SUPPLEMENTAL BENEFITS: Same as Journeyman

6-1249a-LT

Lineman Electrician - Tree Trimmer

12/01/2018

JOB DESCRIPTION Lineman Electrician - Tree Trimmer

DISTRICT 6

ENTIRE COUNTIES

Albany, Allegany, Broome, Cattaraugus, Cayuga, Chautauqua, Chemung, Chenango, Clinton, Columbia, Cortland, Delaware, Dutchess, Erie, Essex, Franklin, Fulton, Genesee, Greene, Hamilton, Herkimer, Jefferson, Lewis, Livingston, Madison, Monroe, Montgomery, Niagara, Oneida, Onondaga, Ontario, Orange, Orleans, Oswego, Otsego, Putnam, Rensselaer, Rockland, Saratoga, Schenectady, Schoharie, Schuyler, Seneca, St. Lawrence, Steuben, Sullivan, Tioga, Tompkins, Ulster, Warren, Washington, Wayne, Wyoming, Yates

WAGES

Per hour:

Applies to line clearance, tree work and right-of-way preparation on all new or existing energized overhead or underground electrical, telephone and CATV lines. This also would include stump removal near underground energized electrical lines, including telephone and CATV lines.

	07/01/2018	01/01/2019
Tree Trimmer	\$ 25.10	\$ 25.79
Equipment Operator	22.20	22.81
Equipment Mechanic	22.20	22.81
Truck Driver	18.48	18.99
Groundman	15.22	15.64
Flag person	10.97	11.27

SUPPLEMENTAL BENEFITS

Per hour worked (but also required on non-worked holidays):

Journeyman	\$ 9.98	\$ 9.98
	*plus 3% of hourly wage	*plus 3% of hourly wage

* The 3% is based on the hourly wage paid, straight time rate or premium rate.

OVERTIME PAY

See (B, E, Q) on OVERTIME PAGE

NOTE: WAGE CAP...Double the straight time hourly base wage shall be the maximum hourly wage compensation for any hour worked. Contractor is still responsible to pay the hourly benefit amount for each hour worked.

HOLIDAY

Paid: See (5, 6, 8, 15, 16, 25) on HOLIDAY PAGE
 Overtime: See (5, 6, 8, 15, 16, 25) on HOLIDAY PAGE

NOTE: All paid holidays falling on a Saturday shall be observed on the preceding Friday. All paid holidays falling on a Sunday shall be observed on the following Monday.

6-1249TT

Mason - Building

12/01/2018

JOB DESCRIPTION Mason - Building

DISTRICT 12

ENTIRE COUNTIES

Albany, Clinton, Columbia, Essex, Franklin, Fulton, Greene, Hamilton, Montgomery, Rensselaer, Saratoga, Schenectady, Schoharie, Warren, Washington

WAGES

Per hour 07/01/2018

Tile/Marble/Terrazzo

Setter \$ 34.66
Finisher 27.16

Four (4), ten (10) hour days may be worked at straight time during a week, Monday thru Thursday. Friday may be used as a make-up day.

NOTE - In order to use the '4 Day/10 Hour Work Schedule,' as your normal schedule, you must submit an 'Employer Registration for Use of 4 Day/10 Hour Work Schedule,' form PW30.1; and there must be a dispensation of hours in place on the project. If the PW30.1 is not submitted you may be liable for overtime payments for work over 8 hours per day.

SUPPLEMENTAL BENEFITS

Per hour worked

Journeyman Setter \$ 19.58
Journeyman Finisher 16.85

OVERTIME PAY

See (B, E, E2, Q) on OVERTIME PAGE

HOLIDAY

Paid: See (1) on HOLIDAY PAGE
Overtime: See (5, 6) on HOLIDAY PAGE

REGISTERED APPRENTICES

Wages per hour

Hour Terms at the following percentage of Journeyman's wage

Setter:

1st term 0-500 hrs 60%
2nd term 501-1500 hrs 70%
3rd term 1501-2500 hrs 80%
4th term 2501-3500 hrs 85%
5th term 3501-4500 hrs 90%
6th term 4501-6000 hrs 95%

Finisher:

1st term 0-500 hrs 70%
2nd term 501-1500 hrs 80%
3rd term 1501-2500 hrs 90%
4th term 2501-3700 hrs 95%

Supplemental Benefits per hour worked

07/01/2018

Setter:

1st term 0-500 hrs \$ 11.23
2nd term 501-1500 hrs 11.23
3rd term 1501-2500 hrs 15.40
4th term 2501-3500 hrs 15.40
5th term 3501-4500 hrs 17.47
6th term 4501-6000 hrs 19.58

Finisher:

1st term 0-500 hrs \$ 10.70
2nd term 501-1500 hrs 10.70
3rd term 1501-2500 hrs 13.77
4th term 2501-3700 hrs 13.77

12-2TS.1

ENTIRE COUNTIES

Clinton, Essex, Franklin

PARTIAL COUNTIES

Warren: Only the Townships of Chester, Hague, Horicon and Johnsbury.

WAGES

Per hour 07/01/2018

Bricklayer	\$ 31.98
Cement Finisher	31.98
Plasterer/Fireproofers*	31.98
Pointer/Caulker/Cleaner	31.98
Stone Mason	31.98
Acid Brick	32.48

(*Fireproofers on Structural only.

Four (4), ten (10) hour days may be worked at straight time during a week, Monday thru Thursday. Friday may be used as a make-up day.

NOTE - In order to use the '4 Day/10 Hour Work Schedule,' as your normal schedule, you must submit an 'Employer Registration for Use of 4 Day/10 Hour Work Schedule,' form PW30.1; and there must be a dispensation of hours in place on the project. If the PW30.1 is not submitted you may be liable for overtime payments for work over 8 hours per day.

SUPPLEMENTAL BENEFITS

Per hour worked

Journeyman	\$ 19.23
------------	----------

OVERTIME PAY

See (B, E, E2, Q) on OVERTIME PAGE

HOLIDAY

Paid: See (1) on HOLIDAY PAGE
 Overtime: See (5, 6) on HOLIDAY PAGE

Note: Any holiday which occurs on Sunday shall be observed the following Monday.

REGISTERED APPRENTICES

Wages per hour

750 hr terms at the following percentage of Journeyman's wage

1st	2nd	3rd	4th	5th	6th	7th	8th
55%	60%	65%	70%	75%	80%	85%	90%

Supplemental Benefits per hour worked

0-500 Hours	\$ 11.48
All others	\$ 19.23

12-2b.8

Mason - Heavy&Highway

12/01/2018

JOB DESCRIPTION Mason - Heavy&Highway

DISTRICT 12

ENTIRE COUNTIES

Albany, Cayuga, Clinton, Columbia, Essex, Franklin, Fulton, Greene, Hamilton, Herkimer, Jefferson, Lewis, Madison, Montgomery, Oneida, Oswego, Rensselaer, Saratoga, Schenectady, Schoharie, St. Lawrence, Warren, Washington

PARTIAL COUNTIES

Onondaga: For Heavy & Highway Cement Mason or Plaster Work in Onondaga County, refer to Mason-Heavy&Highway tag 1-2h/h on.

WAGES

Per hour 07/01/2018

Mason & Bricklayer	\$37.23
--------------------	---------

Additional \$1.00 per hour for work on any swing scaffold or staging suspended by means of ropes or cables.

SUPPLEMENTAL BENEFITS

Per hour worked

Journeyman

\$ 19.51

OVERTIME PAY

See (B, E, E2, Q) on OVERTIME PAGE

HOLIDAY

Paid: See (1) on HOLIDAY PAGE

Overtime: See (5, 6) on HOLIDAY PAGE

Note: If a holiday falls on Sunday, the Monday following shall constitute the day of the legal holiday.

REGISTERED APPRENTICES

Wages per hour

750 HR TERMS at the following percent of Journeyman's wage

1st	2nd	3rd	4th	5th	6th	7th	8th
55%	60%	65%	70%	75%	80%	85%	90%

Supplemental Benefits per hour worked

\$ 19.51

12-2hh.1

Millwright

12/01/2018

JOB DESCRIPTION Millwright

DISTRICT 2

ENTIRE COUNTIES

Clinton, Essex, Franklin, Hamilton, Jefferson, Lewis, Oneida, Onondaga, Oswego, St. Lawrence, Warren, Washington

WAGES

Per hour:	07/01/2018	05/01/2019	07/01/2019 Additional	07/01/2020 Additional
Building	\$ 28.39	\$ 28.39	\$ 1.25	\$ 1.25
Heavy & Highway*	N/A	30.39	1.25	1.25

*Effective 5/1/19, all Heavy and Highway Millwright construction will be paid at the rate indicated above.

NOTE ADDITIONAL PREMIUMS PAID FOR THE FOLLOWING WORK LISTED BELOW (amount subject to any overtime premiums):

- Certified Welders shall receive \$1.75 per hour in addition to the current Millwright's rate provided he/she is directed to perform certified welding.
- If a work site has been declared a hazardous site by the Owner and the use of protective gear (including, as a minimum, air purifying canister-type chemical respirators) are required, then that employee shall receive a \$1.50 premium per hour.
- An employee performing the work of a machinist shall receive \$2.00 per hour in addition to the current Millwright's rate. For the purposes of this premium to apply, a "machinist" is a person who uses a lathe, Bridgeport, milling machine or similar type of tool to make or modify parts.
- When performing work underground at 500 feet and below, the employee shall receive an additional \$0.25. This amount will increase to \$0.50 on 7/1/2019 and to \$1.00 on 7/1/2020

SUPPLEMENTAL BENEFITS

Per hour:

Journeyman	\$ 22.25	\$22.25
------------	----------	---------

OVERTIME PAY

See (B, E, *E2, Q) on OVERTIME PAGE

*Note - Saturday may be used as a make-up day and worked at the straight time rate of pay during a work week when conditions such as weather, power failure, fire, or natural disaster prevent the performance of work on a regular scheduled work day.

HOLIDAY

Paid: See (1) on HOLIDAY PAGE

Overtime: See (5, 6) on HOLIDAY PAGE

Note: Any holiday that falls on Sunday shall be observed the following Monday. Any holiday that falls on Saturday shall be observed the preceding Friday.

REGISTERED APPRENTICES

Wages per hour:

(1)year terms at the following percentage of journeyman's rate.

1st	2nd	3rd	4th
60%	70%	80%	90%

Supplemental Benefits per hour:

Apprentices:

1st term	\$ 10.25
2nd term	18.65
3rd term	19.85
4th term	21.05

2-1163.2

Operating Engineer - Building

12/01/2018

JOB DESCRIPTION Operating Engineer - Building

DISTRICT 1

ENTIRE COUNTIES

Albany, Clinton, Columbia, Essex, Franklin, Fulton, Greene, Hamilton, Herkimer, Montgomery, Otsego, Rensselaer, Saratoga, Schenectady, Schoharie, Warren, Washington

PARTIAL COUNTIES

Dutchess: Defined as north of the northern boundary line of City of Poughkeepsie then due east to Route 115 to Bedelt Road then east along Bedelt Road to VanWagner Road then north along VanWagner Road to Bower Road then east along Bower Road to Rte. 44 east to Route 343 then along Route 343 east to the northern boundary of Town of Dover Plains and east along the northern boundary of Town of Dover Plains to Connecticut.

WAGES

CLASS A1:

Crane, hydraulic cranes, tower crane, locomotive crane, piledriver, cableway, derricks,whirlies, dragline, boom trucks over 5 tons.

CLASS A:

Shovel, all Excavators (including rubber tire full swing), Gradalls, power road grader, all CMI equipment, front-end rubber tire loader, tractor-mounted drill (quarry master), mucking machine, concrete central mix plant, concrete pump, belcrete system, automated asphalt concrete plant, and tractor road paver, boom trucks 5 tons and under, maintenance engineer, self-contained crawler drill-hydraulic rock drill.

CLASS B:

Backhoes (rubber tired backhoe/loader combination), bulldozer, pushcat, tractor, traxcavator, scraper, LeTourneau grader, form fine grader, self-propelled soil compactor (fill roller), asphalt roller, blacktop spreader, power brooms, sweepers, trenching machine, Barber Green loader, side booms, hydro hammer, concrete spreader, concrete finishing machine, one drum hoist, power hoisting (single drum), hoist two drum or more, three drum engine, power hoisting (two drum and over), two drum and swinging engine, three drum swinging engine, hod hoist, A-L frame winches, core and well drillers (one drum), post hole digger, model CHB Vibro-Tamp or similar machine, batch bin and plant operator, dinky locomotive, skid steer loader, track excavator 5/8 cubic yard or smaller, front end rubber tired loader under four cubic yards, vacuum machine (mounted or towed).

CLASS C:

Fork lift, high lift, all terrain fork lift: or similar, oiler, fireman and heavy-duty greaser, boilers and steam generators, pump, vibrator, motor mixer, air compressor, dust collector, welding machine, well point, mechanical heater, generators, temporary light plants, electric submersible pumps 4" and over, murphy type diesel generator, conveyor, elevators, concrete mixer, beltcrete power pack (belcrete system), seeding, and mulching machines, pumps.

* In the event that equipment listed above is operated by robotic control, the classification covering the operation will be the same as if manually operated.

WAGES per hour

07/01/2018

Class # A1	\$ 43.79
Class # A	43.30
Class # B	42.28
Class # C	39.38

Additional \$0.50 per hr for Tower Cranes.

Additional \$1.25 per hr for Cranes with Boom length & jib 150ft. and over.

Additional \$2.25 per hr for Cranes with Boom length & jib 200ft. and over.

Additional \$2.00 per hr over B rate for Nuclear Leader work.

Additional \$0.40 per hr for tunnel or excavation of shaft 40' or more deep.

Additional \$2.50 per hour if work requires Personal Protective Equipment for hazardous waste site activities with a level C or over rating.

SUPPLEMENTAL BENEFITS

Per hour

Journeyman \$ 25.90

OVERTIME PAY

See (B, E, Q) on OVERTIME PAGE

HOLIDAY

Paid: See (1) on HOLIDAY PAGE
Overtime: See (5, 6) on HOLIDAY PAGE

Note: If a holiday falls on Sunday, it will be celebrated on Monday. If the holiday falls on Saturday, it will be celebrated on Friday. Employees who work a Saturday holiday shall be paid double time plus the holiday pay.

REGISTERED APPRENTICES

Wages per hour

1000 hours terms at the following percentage of Journeyman's wage Class B

1st	2nd	3rd	4th
60%	70%	80%	90%

Supplemental Benefits per hour worked

07/01/2018

All terms \$ 21.20

1-158 Alb

Operating Engineer - Heavy&Highway

12/01/2018

JOB DESCRIPTION Operating Engineer - Heavy&Highway

DISTRICT 1

ENTIRE COUNTIES

Albany, Broome, Chenango, Clinton, Columbia, Essex, Franklin, Fulton, Greene, Hamilton, Herkimer, Montgomery, Otsego, Rensselaer, Saratoga, Schenectady, Schoharie, Tioga, Warren, Washington

PARTIAL COUNTIES

Dutchess: Defined as north of the northern boundary line of City of Poughkeepsie then due east to Route 115 to Bedelt Road then east along Bedelt Road to VanWagner Road then north along VanWagner Road to Bower Road then east along Bower Road to Rte. 44 east to Route 343 then along Route 343 east to the northern boundary of Town of Dover Plains and east along the northern boundary of Town of Dover Plains to Connecticut.

WAGES

CLASSIFICATION A:

Asphalt Curb Machine (Self Propelled, Slipform), Asphalt Paver, Automated Concrete Spreader (CMI Type), Automatic Fine Grader, Backhoe (Except Tractor Mounted, Rubber Tired), Backhoe Excavator Full Swing (CAT 212 or similar type), Back Filling Machine, Belt Placer (CMI Type), Blacktop Plant (Automated), Boom truck, Cableway, Caisson Auger, Central Mix Concrete Plant (Automated), Concrete Curb Machine (Self Propelled, Slipform), Concrete Pump, Crane, Cherry Picker, Derricks (steel erection), Dragline, Overhead Crane (Gantry or Straddle type), Pile Driver, Truck Crane, Directional Drilling Machine, Dredge, Dual Drum Paver, Excavator (All PurposeHydraulically Operated) (Gradall or Similar), Front End Loader (4 cu. yd. and Over), Head Tower (Sauerman or Equal), Hoist (Two or Three Drum), Holland Loader, Maintenance Engineer, Mine Hoist, Mucking Machine or Mole, Pavement Breaker(SP) Wertgen; PB-4 and similar type, Power Grader, Profiler (over 105 H.P.), Quad 9, Quarry Master (or equivalent), Scraper, Shovel, Side Boom, Slip Form Paver (If a second man is needed, he shall be an Oiler), Tractor Drawn BeltType Loader, Truck or Trailer Mounted Log Chipper (Self Feeder), Tug Operator (Manned Rented Equipment Excluded), Tunnel Shovel

CLASSIFICATION B:

Backhoe (Tractor Mounted, Rubber Tired), Bituminous Recycler Machine, Bituminous Spreader and Mixer, Blacktop Plant (NonAutomated), Blast or Rotary Drill (Truck or Tractor Mounted), Boring Machine, Cage Hoist, Central Mix Plant [(NonAutomated) and All Concrete Batching Plants], Concrete Paver (Over 16S), Crawler Drill (Self-contained), Crusher, Diesel Power Unit, Drill Rigs, Tractor Mounted, Front End Loader (Under 4 cu. yd.), Greaseman/Lubrication Engineer, HiPressure Boiler (15 lbs. and over), Hoist (One Drum), Hydro-Axe, Kolman Plant Loader and Similar Type Loaders (If Employer requires another man to clean the screen or to maintain the equipment, he shall be an Oiler), L.C.M. Work Boat Operator, Locomotive, Material handling knuckle boom, Mixer (for stabilized base selfpropelled), Monorail Machine, Plant Engineer, Profiler (105 H.P. and under), Pug Mill, Pump Crete, Ready Mix Concrete Plant, Refrigeration Equipment (for soil stabilization), Road Widener, Roller (all above subgrade), Sea Mule, Self-contained Ride-on Rock Drill(Excluding Air-Track Type Drill), Skidder, Tractor with Dozer and/or Pusher, Trencher, Tugger Hoist, Vacuum machine (mounted or towed), Vermeer saw (ride on, any size or type), Welder

CLASSIFICATION C:

A Frame Winch Hoist on Truck, Articulated Heavy Hauler, Aggregate Plant, Asphalt or Concrete Grooving Machine (ride on), Ballast Regulator(Ride-on), Boiler (used in conjunction with production), Bituminous Heater (self-propelled), Boat (powered), Cement and Bin Operator, Concrete Pavement Spreader and Finisher Concrete Paver or Mixer (16' and under), Concrete Saw (self-propelled), Conveyor, Deck Hand, Directional Drill Machine Locator, Drill (Core and Well), Farm Tractor with accessories, Fine Grade Machine, Fireman, Fork Lift, Form Tamper, Grout Pump, Gunit Machine, Hammers (Hydraulic self-propelled), Hydra-Spiker (ride-on), Hydraulic Pump (jacking system), Hydro-Blaster (Water), Mulching Machine, Oiler, Parapet Concrete or Pavement Grinder, Post Hole Digger and Post Driver, Power Broom (towed), Power Heaterman, Power Sweeper, Revinius Widener, Roller (Grade and Fill), Scarifier (ride-on), Shell Winder, Skid steer loader (Bobcat or similar), Span-Saw (ride-on), Steam Cleaner, Tamper (ride-on), Tie Extractor (ride-on), Tie Handler (ride-on), Tie Inserter (ride-on), Tie Spacer (ride-on), Tire Repair, Track Liner (ride-on), Tractor, Tractor (with towed accessories), Vibratory Compactor, Vibro Tamp, Well Point, and the following hands-off equipment: Compressors, Dust Collectors, Generators, Pumps, Welding Machines, Light Plants and Heaters

- Note for all above classifications of Operating Engineer - In the event that equipment listed above is operated by robotic control, the classification covering the operation will be the same as if manually operated.

WAGES per hour

	07/01/2018
Master Mechanic	\$ 45.08
Class A*	43.47
Class B	42.56
Class C	39.99

Additional \$2.00 per hour for All Employees who work a single irregular work shift starting from 5:00 PM to 1:00 AM that is mandated by the Contracting Agency.

Additional \$2.50 per hr. for hazardous waste removal work on State and/or Federally designated waste site which require employees to wear Level C or above forms of personal protection.

(*) Premiums for CRANES is based upon Class A rates with the following premiums:

- Additional \$4.00 per hr for Tower Cranes, including self erecting.
- Additional \$3.00 per hr for Lattice Boom Cranes and all other cranes with a manufacturers rating of fifty (50) tons and over.
- Additional \$2.00 per hr for all Hydraulic Cranes and Derricks with a manufacturer's rating of 49 ton and below, including boom trucks.

Four (4), ten (10) hour days may be worked at straight time during a week, Monday thru Thursday. Friday may be used as a make-up day.

NOTE - In order to use the '4 Day/10 Hour Work schedule', as your normal schedule, you must submit an 'Employer Registration for Use of 4 Day/10 Hour Work Schedule,' form PW30.1; and there must be a dispensation of hours in place on the project. If the PW30.1 is not submitted you may be liable for overtime payments for work over 8 hours per day.

SUPPLEMENTAL BENEFITS

Per hour

Journeyman	\$ 26.10
------------	----------

OVERTIME PAY

See (B, E, Q) on OVERTIME PAGE

HOLIDAY

Paid: See (5, 6) on HOLIDAY PAGE

Overtime: See (5, 6) on HOLIDAY PAGE

Note: If the holiday falls on Sunday, it will be celebrated on Monday. If the holiday falls on a Saturday, it will be celebrated on Saturday.

REGISTERED APPRENTICES

Wages per hour

1000 hours terms at the following percentage of Journeyman's wage Class B

1st	2nd	3rd	4th
60%	70%	80%	90%

Supplemental Benefits per hour worked

	07/01/2018
All Terms	\$ 21.50

1-158H/H Alb

Operating Engineer - Marine Dredging

12/01/2018

JOB DESCRIPTION Operating Engineer - Marine Dredging
ENTIRE COUNTIES

DISTRICT 4

Albany, Bronx, Cayuga, Chautauqua, Clinton, Columbia, Dutchess, Erie, Essex, Franklin, Greene, Jefferson, Kings, Monroe, Nassau, New York, Niagara, Orange, Orleans, Oswego, Putnam, Queens, Rensselaer, Richmond, Rockland, St. Lawrence, Suffolk, Ulster, Washington, Wayne, Westchester

WAGES

These wages do not apply to Operating Engineers on land based construction projects. For those projects, please see the Operating Engineer Heavy/Highway Rates. The wage rates below for barge mounted cranes and other equipment are only for marine dredging work in navigable waters found in the counties listed above.

Per Hour:

DREDGING OPERATIONS 07/01/2018
 CLASS A
 Operator, Leverman, \$ 38.18
 Lead Dredgeman

CLASS A1 To conform to Operating Engineer
 Dozer, Front Loader Prevailing Wage in locality where work
 Operator is being performed including benefits.

CLASS B \$ 33.02
 Barge Operator
 Spider/Spill
 Tug Operator(over1000hp),
 OperatorII, Fill Placer,
 Derrick Operator, Engineer,
 Chief Mate, Electrician,
 Chief Welder,
 Maintenance Engineer

Certified Welder, \$ 31.09
 Boat Operator(licensed)

CLASS C \$ 30.24
 Drag Barge Operator,
 Steward, Mate,
 Assistant Fill Placer,

Welder (please add)\$ 0.06

Boat Operator \$ 29.26

CLASS D \$ 24.30
 Shoreman, Deckhand,
 Rodman, Scowman, Cook,
 Messman, Porter/Janitor

Oiler(please add)\$ 0.09

SUPPLEMENTAL BENEFITS

Per Hour:

THE FOLLOWING SUPPLEMENTAL BENEFITS APPLY TO ALL CATEGORIES

All Classes A & B 07/01/2018
 \$11.23 plus 8%
 of straight time
 wage, Overtime hours
 add \$ 0.63

All Class C \$10.93 plus 8%
 of straight time
 wage, Overtime hours
 add \$ 0.48

All Class D \$10.63 plus 8%
 of straight time

wage, Overtime hours
add \$ 0.33

OVERTIME PAY

See (B, F, R) on OVERTIME PAGE

HOLIDAY

Paid: See (1) on HOLIDAY PAGE
Overtime: See (5, 6, 8, 15, 26) on HOLIDAY PAGE

4-25a-MarDredge

Operating Engineer - Survey Crew

12/01/2018

JOB DESCRIPTION Operating Engineer - Survey Crew

DISTRICT 12

ENTIRE COUNTIES

Albany, Allegany, Broome, Cayuga, Chemung, Chenango, Clinton, Columbia, Cortland, Essex, Franklin, Fulton, Greene, Hamilton, Herkimer, Jefferson, Lewis, Livingston, Madison, Monroe, Montgomery, Niagara, Oneida, Onondaga, Ontario, Oswego, Otsego, Rensselaer, Saratoga, Schoenectady, Schoharie, Schuyler, Seneca, St. Lawrence, Steuben, Tioga, Tompkins, Warren, Washington, Wayne, Yates

PARTIAL COUNTIES

Dutchess: The northern portion of the county from the northern boundary line of the City of Poughkeepsie, north.
Genesee: Only the portion of the county that lies east of a line down the center of Route 98 to include all area that lies within the City of Batavia.

WAGES

These rates apply to Building, Tunnel and Heavy Highway.

Per hour:

SURVEY CLASSIFICATIONS:

Party Chief - One who directs a survey party.
Instrument Person - One who operates the surveying instruments.
Rod Person - One who holds the rods and assists the Instrument Person.

07/01/2018

Party Chief \$ 40.45
Instrument Person 38.17
Rod Person 26.48

Additional \$3.00/hr. for Tunnel Work
Additional \$2.50/hr. for Hazardous Work Site

SUPPLEMENTAL BENEFITS

Per hour worked:

Journeyman \$ 25.75

OVERTIME PAY

See (B, E, P, T) on OVERTIME PAGE

HOLIDAY

Paid: See (5, 6) on HOLIDAY PAGE
Overtime: See (5, 6) on HOLIDAY PAGE

REGISTERED APPRENTICES

WAGES: 1000 hour terms based on the Percentage of Rod Persons Wage:

07/01/2018

0-1000 60%
1001-2000 70%
2001-3000 80%

SUPPLEMENTAL BENEFIT per hour worked:

0-1000 \$ 15.45
1001-2000 \$ 18.03
2001-3000 \$ 20.60

12-158-545 D.H.H.

Operating Engineer - Survey Crew - Consulting Engineer

12/01/2018

JOB DESCRIPTION Operating Engineer - Survey Crew - Consulting Engineer

DISTRICT 12

ENTIRE COUNTIES

Albany, Allegany, Broome, Cayuga, Chemung, Chenango, Clinton, Columbia, Cortland, Essex, Franklin, Fulton, Greene, Hamilton, Herkimer, Jefferson, Lewis, Livingston, Madison, Monroe, Montgomery, Niagara, Oneida, Onondaga, Ontario, Oswego, Otsego, Rensselaer, Saratoga, Schenectady, Schoharie, Schuyler, Seneca, St. Lawrence, Steuben, Tioga, Tompkins, Warren, Washington, Wayne, Yates

PARTIAL COUNTIES

Dutchess: The northern portion of the county from the northern boundary line of the City of Poughkeepsie, north.
Genesee: Only the portion of the county that lies east of a line down the center of Route 98 to include all area that lies within the City of Batavia.

WAGES

These rates apply to feasibility and preliminary design surveying, line and grade surveying for inspection or supervision of construction when performed under a Consulting Engineer Agreement.

Per hour:

SURVEY CLASSIFICATIONS:

- Party Chief - One who directs a survey party.
- Instrument Person - One who operates the surveying instruments.
- Rod Person - One who holds the rods and assists the Instrument Person.

07/01/2018

Party Chief	\$ 41.40
Instrument Person	38.02
Rod Person	28.12

Additional \$3.00/hr. for Tunnel Work.
Additional \$2.50/hr. for EPA or DEC certified toxic or hazardous waste work.

SUPPLEMENTAL BENEFITS

Per hour worked:

Journeyman	\$ 24.90
------------	----------

OVERTIME PAY

See (B, E, P, T) on OVERTIME PAGE

HOLIDAY

Paid: See (5, 6) on HOLIDAY PAGE
Overtime: See (5, 6) on HOLIDAY PAGE

REGISTERED APPRENTICES

WAGES: 1000 hour terms based on percentage of Rod Persons Wage:

07/01/2018

0-1000	60%
1001-2000	70%
2001-3000	80%

SUPPLEMENTAL BENIFIT per hour worked:

0-1000	\$ 16.82
1001-2000	\$ 19.63
2001-3000	\$ 22.45

12-158-545 DCE

Operating Engineer - Tunnel

12/01/2018

JOB DESCRIPTION Operating Engineer - Tunnel

DISTRICT 7

ENTIRE COUNTIES

Albany, Allegany, Broome, Cayuga, Chemung, Chenango, Clinton, Columbia, Cortland, Essex, Franklin, Fulton, Greene, Hamilton, Herkimer, Jefferson, Lewis, Livingston, Madison, Monroe, Montgomery, Oneida, Onondaga, Ontario, Oswego, Otsego, Rensselaer, Saratoga, Schenectady, Schoharie, Schuyler, Seneca, St. Lawrence, Steuben, Tioga, Tompkins, Warren, Washington, Wayne, Yates

PARTIAL COUNTIES

Dutchess: Northern part of Dutchess to the northern boundary line of the City of Poughkeepsie then due east to Route 115 to Bedelt Road then east along Bedelt Road to VanWagner Road then north along VanWagner Road to Bower Road then east along Bower Road to Rte. 44 east to Rte. 343 then along Rte. 343 east to the northern boundary of the Town of Dover Plains and east along the northern boundary of the Town of Dover Plains to Connecticut.
Genesee: Only that portion of the county that lies east of a line drawn down the center of Route 98 and the entirety of the City of Batavia.

WAGES

CLASS A: Automatic Concrete Spreader (CMI Type); Automatic Fine Grader; Backhoe (except tractor mounted, rubber tired); Belt Placer (CMI Type); Blacktop Plant (automated); Cableway; Caisson Auger; Central Mix Concrete Plant (automated); Concrete Curb Machine (self-propelled slipform); Concrete Pump (8" or over); Dredge; Dual Drum Paver; Excavator; Front End Loader (4 cu. yd & over); Gradall; Head Tower (Sauerman or Equal); Hoist (shaft); Hoist (two or three Drum); Log Chipper/Loader (self-feeder); Maintenance Engineer (shaft and tunnel); any Mechanical Shaft Drill; Mine Hoist; Mining Machine (Mole and similar types); Mucking Machine or Mole; Overhead Crane (Gantry or Straddle Type); Pile Driver; Power Grader; Remote Controlled Mole or Tunnel Machine; Scraper; Shovel; Side Boom; Slip Form Paver (If a second man is needed, they shall be an Oiler); Tripper/Maintenance Engineer (shaft & tunnel); Tractor Drawn Belt-Type Loader; Tug Operator (manned rented equipment excluded); Tunnel Shovel

CLASS B: Automated Central Mix Concrete Plant; Backhoe (topside); Backhoe (track mounted, rubber tired); Backhoe (topside); Bituminous Spreader and Mixer, Blacktop Plant (non-automated); Blast or Rotary Drill (truck or tractor mounted); Boring Machine; Cage Hoist; Central Mix Plant (non-automated); all Concrete Batching Plants; Compressors (4 or less exceeding 2,000 c.f.m. combined capacity); Concrete Pump; Crusher; Diesel Power Unit; Drill Rigs (tractor mounted); Front End Loader (under 4 cu. yd.); Grayco Epoxy Machine; Hoist (One Drum); Hoist (2 or 3 drum topside); Knuckle Boom material handler; Kolman Plant Loader & similar type Loaders (if employer requires another person to clean the screen or to maintain the equipment, they shall be an Oiler); L.C.M. Work Boat Operator; Locomotive; Maintenance Engineer (topside); Maintenance Grease Man; Mixer (for stabilized base-self propelled); Monorail Machine; Plant Engineer; Personnel Hoist; Pump Crete; Ready Mix Concrete Plant; Refrigeration Equipment (for soil stabilization); Road Widener; Roller (all above sub-grade); Sea Mule; Shotcrete Machine; Shovel (topside); Tractor with Dozer and/or Pusher; Trencher; Tugger Hoist; Tunnel Locomotive; Welder; Winch; Winch Cat

CLASS C: A Frame Truck; All Terrain Telescoping Material Handler; Ballast Regulator (ride-on); Compressors (4 not to exceed 2,000 c.f.m. combined capacity; or 3 or less with more than 1200 c.f.m. but not to exceed 2,000 c.f.m.); Compressors ((any size, but subject to other provisions for compressors), Dust Collectors, Generators, Pumps, Welding Machines, Light Plants (4 or any type combination)); Concrete Pavement Spreaders and Finishers; Conveyor; Drill (core); Drill (well); Electric Pump used in conjunction with Well Point System; Farm Tractor with Accessories; Fine Grade Machine; Fork Lift; Grout Pump (over 5 cu. ft.); Gunite Machine; Hammers (hydraulic-self-propelled); Hydra-Spiker (ride-on); Hydra-Blaster (water); Hydro-Blaster; Motorized Form Carrier; Post Hole Digger and Post Driver; Power Sweeper; Roller grade & fill); Scarifer (ride-on); Span-Saw (ride-on); Submersible Electric Pump (when used in lieu of well points); Tamper (ride-on); Tie-Extractor (ride-on), Tie Handler (ride-on), Tie Inserter (ride-on), Tie Spacer (ride-on); Track Liner (ride-on); Tractor with towed accessories; Vibratory Compactor; Vibro Tamp, Well Point

CLASS D: Aggregate Plant; Cement & Bin Operator; Compressors (3 or less not to exceed 1,200 c.f.m. combined capacity); Compressors ((any size, but subject to other provisions for compressors), Dust Collectors, Generators, Pumps, Welding Machines, Light Plants (3 or less or any type or combination)); Concrete Saw (self-propelled); Form Tamper; Greaseman; Hydraulic Pump (jacking system); Junior Engineer; Light Plants; Mulching Machine; Oiler; Parapet Concrete or Pavement Grinder; Power Broom (towed); Power Heaterman (when used for production); Revinus Widener; Shell Winder; Steam Cleaner; Tractor

WAGES per hour:

07/01/2018

Master Mechanic	\$ 46.65
CLASS A	44.24
CLASS B	43.02
CLASS C	40.23
CLASS D	37.22

Additional \$5.00 per hour for Hazardous Waste Work on a state or federally designated hazardous waste site where the Operating Engineer is in direct contact with hazardous material and when personal protective equipment is required for respiratory, skin and eye protection. Fringe benefits will be paid at the hourly wage premium.

CRANES:

Crane 1: All cranes, including self-erecting to be paid \$4.00 per hour over the Class A rate.

Crane 2: All Lattice Boom Cranes and all cranes with a manufacturer's rating of fifty (50) ton and over to be paid \$3.00 per hour over Class A rate.

Crane 3: All hydraulic cranes and derricks with a manufacturer's rating of forty nine (49) ton and below, including boom trucks, to be paid \$2.00 per hour over Class A rate.

Crane 1	\$ 48.24
Crane 2	47.24
Crane 3	46.24

SUPPLEMENTAL BENEFITS

Per hour:

\$ 28.40

OVERTIME PAY

See (B, B2, E, Q, X) on OVERTIME PAGE

HOLIDAY

Paid: See (5, 6) on HOLIDAY PAGE

Overtime: See (5, 6) on HOLIDAY PAGE

If a holiday falls on Sunday, it shall be observed on Monday.

REGISTERED APPRENTICES

WAGES:(1000) hours terms at the following percentage of Journeyman's wage.

1st term	60% of Class B
2nd term	65% of Class B
3rd term	70% of Class B
4th term	75% of Class B

SUPPLEMENTAL BENEFITS per hour paid: Same as Journeyman

7-158-832TL.

Painter **12/01/2018**

JOB DESCRIPTION Painter

DISTRICT 1

ENTIRE COUNTIES

Albany, Essex, Fulton, Hamilton, Montgomery, Rensselaer, Saratoga, Schenectady, Schoharie, Warren, Washington

WAGES

Per hour	07/01/2018	05/01/2019 Additional
Painter\Wallcover	\$ 28.59	\$1.40
Drywall Finishers	28.59	1.40
Spray Rate	28.59	1.40
Structural Steel*	29.59	1.40
Lead Abatement	29.59	1.40
Lead Abatement on Structural Steel	30.59	1.40

(*)Employees working on objects with the use of swing stage, boatswain chair, pick and cables only will be paid at Structural Steel rate.

Bridge Painter

See Bridge Painter rates for the following work:

All Bridges and Tanks

SUPPLEMENTAL BENEFITS

Per hour

Journeyman \$ 15.90

OVERTIME PAY

See (B, E2, H) on OVERTIME PAGE

HOLIDAY

Paid: See (1) on HOLIDAY PAGE

Overtime: See (5, 6) on HOLIDAY PAGE

Note: If the holiday falls on Sunday, it shall be observed on Monday.

REGISTERED APPRENTICES

Wages per hour

1000 hour terms at the following percentage of Journeyman's base wage

1st	2nd	3rd	4th	5th	6th
45%	50%	60%	70%	80%	90%

Supplemental Benefits per hour worked

All Terms \$ 15.90

1-201-P

Painter - Bridge & Structural Steel **12/01/2018**

JOB DESCRIPTION Painter - Bridge & Structural Steel

DISTRICT 8

ENTIRE COUNTIES

Albany, Bronx, Clinton, Columbia, Dutchess, Essex, Franklin, Fulton, Greene, Hamilton, Kings, Montgomery, Nassau, New York, Orange, Putnam, Queens, Rensselaer, Richmond, Rockland, Saratoga, Schenectady, Schoharie, Suffolk, Sullivan, Ulster, Warren, Washington, Westchester

WAGES

Per Hour:

STEEL:

Bridge Painting:	07/01/2018	10/01/2018
	\$ 49.50	\$ 49.50
	+ 6.38*	+ 6.38*

ADDITIONAL \$6.00 per hour for POWER TOOL/SPRAY, whether straight time or overtime.

NOTE: All premium wages are to be calculated on base rate per hour only.

* For the period of May 1st to November 15th, this amount is payable up to 40 hours. For the period of Nov 16th to April 30th, this amount is payable up to 50 hours. EXCEPTION: First and last week of employment, and for the weeks of Memorial Day, Independence Day and Labor Day, where the amount is paid for the actual number of hours worked (no cap).

NOTE: Generally, for Bridge Painting Contracts, ALL WORKERS on and off the bridge (including Flagmen) are to be paid Painter's Rate; the contract must be ONLY for Bridge Painting.

SUPPLEMENTAL BENEFITS

Per Hour:

Journeyworker:	07/01/2018	10/01/2018
	\$ 8.25	\$ 9.50
	+ 24.35*	+ 26.05*

* For the period of May 1st to November 15th, this amount is payable up to 40 hours. For the period of Nov 16th to April 30th, this amount is payable up to 50 hours. EXCEPTION: First and last week of employment, and for the weeks of Memorial Day, Independence Day and Labor Day, where the amount is paid for the actual number of hours worked (no cap).

OVERTIME PAY

See (A, F, R) on OVERTIME PAGE

HOLIDAY

Paid: See (1) on HOLIDAY PAGE
 Overtime: See (4, 6) on HOLIDAY PAGE

REGISTERED APPRENTICES

Wage - Per hour:

Apprentices: (1) year terms

	07/01/2018	10/01/2018
1st year	\$ 22.65	\$ 23.13
2nd year	33.98	34.73
3rd year	45.30	46.30

Supplemental Benefits - Per hour:

1st year	\$ 12.76	\$ 13.44
2nd year	19.14	20.16
3rd year	25.52	26.88

8-DC-9/806/155-BrSS

Painter - Line Striping **12/01/2018**

JOB DESCRIPTION Painter - Line Striping

DISTRICT 8

ENTIRE COUNTIES

Albany, Bronx, Clinton, Columbia, Dutchess, Essex, Franklin, Fulton, Greene, Hamilton, Kings, Montgomery, Nassau, New York, Orange, Putnam, Queens, Rensselaer, Richmond, Rockland, Saratoga, Schenectady, Schoharie, Suffolk, Sullivan, Ulster, Warren, Washington, Westchester

WAGES

Per hour:

Painter (Striping-Highway):	07/01/2018
Striping-Machine Operator*	\$ 29.93

Linerman Thermoplastic \$ 36.06

Note: * Includes but is not limited to: Positioning of cones and directing of traffic using hand held devices. Excludes the Driver/Operator of equipment used in the maintenance and protection of traffic safety.

Four (4), ten (10) hour days may be worked at straight time during a week, Monday thru Thursday. Friday may be used as a make-up day.

NOTE - In order to use the '4 Day/10 Hour Work Schedule,' as your normal schedule, you must submit an 'Employer Registration for Use of 4 Day/10 Hour Work Schedule,' form PW30.1; and there must be a dispensation of hours in place on the project. If the PW30.1 is not submitted you may be liable for overtime payments for work over 8 hours per day.

SUPPLEMENTAL BENEFITS

Per hour paid: 07/01/2018
 Journeyworker:

Striping-Machine operator \$ 7.44
 Linerman Thermoplastic \$ 7.44

OVERTIME PAY

See (B, B2, E2, F, S) on OVERTIME PAGE

HOLIDAY

Paid: See (5, 20) on HOLIDAY PAGE
 Overtime: See (5, 20) on HOLIDAY PAGE

REGISTERED APPRENTICES

One (1) year terms at the following wage rates:
 07/01/2018

1st term \$ 11.97
 2nd term 17.96
 3rd term 23.94

Supplemental Benefits per hour:

1st term \$ 7.44
 2nd term 7.44
 3rd term 7.44

8-1456-LS

Painter - Metal Polisher

12/01/2018

JOB DESCRIPTION Painter - Metal Polisher

DISTRICT 8

ENTIRE COUNTIES

Albany, Allegany, Bronx, Broome, Cattaraugus, Cayuga, Chautauqua, Chemung, Chenango, Clinton, Columbia, Cortland, Delaware, Dutchess, Erie, Essex, Franklin, Fulton, Genesee, Greene, Hamilton, Herkimer, Jefferson, Kings, Lewis, Livingston, Madison, Monroe, Montgomery, Nassau, New York, Niagara, Oneida, Onondaga, Ontario, Orange, Orleans, Oswego, Otsego, Putnam, Queens, Rensselaer, Richmond, Rockland, Saratoga, Schenectady, Schoharie, Schuylar, Seneca, St. Lawrence, Steuben, Suffolk, Sullivan, Tioga, Tompkins, Ulster, Warren, Washington, Wayne, Westchester, Wyoming, Yates

WAGES

07/01/2018
 Metal Polisher \$ 30.58
 Metal Polisher* 31.53
 Metal Polisher** 34.08

*Note: Applies on New Construction & complete renovation

** Note: Applies when working on scaffolds over 34 feet.

SUPPLEMENTAL BENEFITS

Per Hour: 07/01/2018

Journeyworker:
 All classification \$ 7.72

OVERTIME PAY

See (B, E, P, T) on OVERTIME PAGE

HOLIDAY

Paid: See (5, 6, 11, 15, 16, 25, 26) on HOLIDAY PAGE
 Overtime: See (5, 6, 9, 11, 15, 16, 25, 26) on HOLIDAY PAGE

REGISTERED APPRENTICES

Wages per hour:

One (1) year term at the following wage rates:

	07/01/2018	01/01/2019
1st year	\$ 13.00	\$ 15.00
2nd year	13.00	15.00
3rd year	15.75	15.75
1st year*	\$ 15.39	\$ 17.39
2nd year*	15.44	17.44
3rd year*	16.29	18.29
1st year**	\$ 17.50	19.50
2nd year**	17.50	19.50
3rd year**	18.25	20.25

*Note: Applies on New Construction & complete renovation

** Note: Applies when working on scaffolds over 34 feet.

Supplemental benefits:

Per hour:

	07/01/2018	01/01/2019
1st year	\$ 5.52	\$ 5.52
2nd year	5.52	5.52
3rd year	5.52	5.52

8-8A/28A-MP

Plumber

12/01/2018

JOB DESCRIPTION Plumber

DISTRICT 1

ENTIRE COUNTIES

Essex

PARTIAL COUNTIES

Franklin: Entire County except for the Village of Hogansburg and the St. Regis Indian Reservation.

Hamilton: The Townships of Long Lake and Indian Lake

WAGES

Per hour

	07/01/2018	05/01/2019
Plumber & Steamfitter	\$ 38.00	+\$1.65

SUPPLEMENTAL BENEFITS

Per hour

Journeyman	\$ 19.60 +10.23*
------------	---------------------

* This portion of the benefit is subject to the SAME PREMIUM as shown for overtime and applicable to paid Holidays.

OVERTIME PAY

See (B, E, Q) on OVERTIME PAGE

HOLIDAY

Paid: See (22) on HOLIDAY PAGE

Overtime: See (5, 6, 16, 23) on HOLIDAY PAGE

Note: Whenever a Holiday falls on a Saturday, the preceding day, Friday, shall be observed as the Holiday. If a Holiday falls on a Sunday, the following day, Monday shall be observed as the Holiday.

REGISTERED APPRENTICES

Wages per hour

One year terms at the following percentage of Journeyman's wage

1st yr	50%
2nd yr	60%
3rd yr	70%
4th yr	80%
5th yr	90%

Supplemental Benefits per hour worked

1st yr	\$ 17.03 + 5.12*
2nd yr	17.54 + 6.14*
3rd yr	18.06 + 7.16*
4th yr	18.57 + 8.18*
5th yr	19.09 + 9.21*

* This portion of the benefit is subject to the SAME PREMIUM as shown for overtime.
 * This portion per hour paid.

1-773EF-SF

Roofer **12/01/2018**

JOB DESCRIPTION Roofer

DISTRICT 1

ENTIRE COUNTIES

Albany, Clinton, Columbia, Essex, Fulton, Greene, Hamilton, Montgomery, Rensselaer, Saratoga, Schenectady, Warren, Washington

WAGES

Per hour 07/01/2018

Roofer/Waterproofer	\$ 30.05
Asphalt Cold Process	30.55
Fluid Applied Roof	30.55
Pitch & Asbestos	32.05

Shift Work:

On government mandated shift work starting after 12:00pm and before 4:00am workers shall be paid \$4.00 additional per hour

SUPPLEMENTAL BENEFITS

Per hour

Journeyman \$ 19.27

OVERTIME PAY

See (B, E, Q) on OVERTIME PAGE.

HOLIDAY

Paid: See (1) on HOLIDAY PAGE
 Overtime: See (5, 6) on HOLIDAY PAGE

Note: When any Holiday falls on Saturday, the Friday before such Holiday shall be recognized as the legal Holiday. When a Holiday falls on Sunday, it shall be observed the following Monday.

REGISTERED APPRENTICES

Wages per hour

Apprentice terms at the following per cent of the Roofer/Waterproofer rate. For Pitch & Asbestos work, an additional \$2.00 must be paid in wages. For Asphalt Cold Process work and Fluid Applied Roof coating, an additional \$0.50 must be paid in the wages.

1st Term	58%
1500 hrs.	
2nd Term	74%
1 yr. and 1500 hrs.	
3rd Term	90%
1 yr. and 1050 hrs.	

Supplemental Benefits per hour worked

1st Term	\$ 17.69
2nd Term	18.12
3rd Term	18.60

1-241

Sheetmetal Worker **12/01/2018**

JOB DESCRIPTION Sheetmetal Worker

DISTRICT 1

ENTIRE COUNTIES

Albany, Clinton, Columbia, Essex, Franklin, Fulton, Greene, Hamilton, Montgomery, Rensselaer, Saratoga, Schenectady, Schoharie, Warren, Washington

WAGES

Per hour
 07/01/2018

Sheetmetal Worker \$32.55

All work requiring HAZWOPER Training additional \$1.00 per hour

SUPPLEMENTAL BENEFITS

Per hour

Journeyman \$31.95

OVERTIME PAY

See (B,E,E5,Q) on OVERTIME PAGE

HOLIDAY

Paid: See (1) on HOLIDAY PAGE
 Overtime: See (5, 6) on HOLIDAY PAGE

When any holiday falls on Saturday, the Friday before such holiday shall be recognized as the legal holiday. Any holiday falling on Sunday, the following Monday shall be recognized as the legal holiday.

REGISTERED APPRENTICES

Wages per hour

6 Month Terms at the following rate:

1st term	\$18.05
2nd term	\$19.56
3rd term	\$20.32
4th term	\$21.08
5th term	\$19.96
6th term	\$20.96
7th term	\$22.61
8th term	\$24.27
9th term	\$25.93
10th term	\$27.58

Supplemental Benefits per hour worked

1st term	\$19.45
2nd term	20.03
3rd term	20.32
4th term	20.74
5th term	26.48
6th term	26.91
7th term	27.63
8th term	28.35
9th term	29.07
10th term	29.79

Sprinkler Fitter

12/01/2018

JOB DESCRIPTION Sprinkler Fitter

DISTRICT 1

ENTIRE COUNTIES

Alliegany, Broome, Cattaraugus, Cayuga, Chautauqua, Chemung, Chenango, Clinton, Columbia, Cortland, Delaware, Erie, Essex, Franklin, Fulton, Genesee, Greene, Hamilton, Herkimer, Jefferson, Lewis, Livingston, Madison, Monroe, Montgomery, Niagara, Oneida, Onondaga, Ontario, Orleans, Oswego, Otsego, Schoharie, Schuyler, Seneca, St. Lawrence, Steuben, Tioga, Tompkins, Washington, Wayne, Wyoming, Yates

WAGES

Per hour	07/01/2018	01/01/2019
Sprinkler Fitter	\$ 34.91	34.91

SUPPLEMENTAL BENEFITS

Per hour

Journeyman \$ 23.14 23.69

OVERTIME PAY

See (B, E, Q) on OVERTIME PAGE

HOLIDAY

Paid: See (1) on HOLIDAY PAGE
 Overtime: See (5, 6) on HOLIDAY PAGE

Note: When a holiday falls on Sunday, the following Monday shall be considered a holiday and all work performed on either day shall be at the double time rate. When a holiday falls on Saturday, the preceding Friday shall be considered a holiday and all work performed on either day shall be at the double time rate.

REGISTERED APPRENTICES

Wages per hour

For Apprentices HIRED ON OR AFTER 04/01/2010:

One Half Year terms at the following percentage of journeyman's wage.

1st	2nd	3rd	4th	5th	6th	7th	8th	9th	10th
45%	50%	55%	60%	65%	70%	75%	80%	85%	90%

Supplemental Benefits per hour worked

1st	2nd	3rd	4th	5th	6th	7th	8th	9th	10th
\$ 8.93	\$ 8.97	\$ 17.09	\$ 17.13	\$ 17.68	\$ 17.72	\$ 17.77	\$ 17.81	\$ 17.86	\$ 17.90

For Apprentices HIRED ON OR AFTER 04/01/2013:

One Half Year terms at the following percentage of journeyman's wage.

1st	2nd	3rd	4th	5th	6th	7th	8th	9th	10th
45%	50%	55%	60%	65%	70%	75%	80%	85%	90%

Supplemental Benefits per hour worked

1st	2nd	3rd	4th	5th	6th	7th	8th	9th	10th
\$ 8.27	\$ 8.27	\$ 17.24	\$ 17.24	\$ 17.49	\$ 17.49	\$ 17.49	\$ 17.49	\$ 17.49	\$ 17.49

1-669

Teamster - Building **12/01/2018**

JOB DESCRIPTION Teamster - Building

DISTRICT 7

ENTIRE COUNTIES

Clinton, Essex, Franklin, Jefferson, St. Lawrence

PARTIAL COUNTIES

Lewis: Only the Townships of Croghan, Denmark, Diana, New Bremen, Harrisburg, Montague, Osceola and Pinckney.

Oswego: Only the Towns of Boylston, Redfield, and Sandy Creek.

Warren: Only the Townships of Hague, Horicon, Chester and Johnsbury.

WAGES

GROUP # 1: Fuel Trucks, Fork Lift (Warehouse & Storage Area Only), Bus, Warehouse, Yardman, Truck Helper, Pickups, Panel Truck, Flatbody Material Trucks (straight Jobs), Single axle Dump Trucks, Dumpsters, Material Checkers & Receivers, Greasers, Tiremen, Mechanic Helpers and Parts Chasers.

GROUP # 2: Tandems, Mechanics & Batch Trucks.

GROUP # 3: Semi Trailers, Low Boys, Asphalt Distributor Trucks, and Agitator Mixer Truck, Dump Crete Type Vehicles and 3 axle Dump trucks.

GROUP # 4: Asbestos Removal, Special earth moving Euclid type or similar off highway equip.(non self load.) Articulated and all-track dump trucks.

Wages per hour

07/01/2018

Building:

Group #1	\$ 23.58
Group #2	24.58
Group #3	24.68
Group #4	23.84

SUPPLEMENTAL BENEFITS

Per hour:

All groups \$ 21.51

OVERTIME PAY

See (B, E, Q) on OVERTIME PAGE

HOLIDAY

Paid: See (1) on HOLIDAY PAGE
Overtime: See (5, 6) on HOLIDAY PAGE

7-687B

Teamster - Heavy&Highway

12/01/2018

JOB DESCRIPTION Teamster - Heavy&Highway

DISTRICT 7

ENTIRE COUNTIES

Clinton, Essex, Franklin, Jefferson, St. Lawrence

PARTIAL COUNTIES

Lewis: Only the Townships of Croghan, Denmark, Diana, New Bremen, Harrisburg, Montague, Osceola and Pinckney.
Oswego: Only the Towns of Boylston, Redfield, and Sandy Creek.
Warren: Only the Townships of Hague, Horicon, Chester and Johnsbury.

WAGES

GROUP 1: Warehousemen, Yardmen, Truck Helpers, Pickups, Panel Trucks, Flatboy Material Trucks(straight jobs), Single Axle Dump Trucks, Dumpsters, Material Checkers and Receivers, Greasers, Truck Tirmen, Mechanics Helpers and Parts Chasers. Fork Lift (storage & warehouse areas only) Tandems and Batch Trucks, Mechanics, Dispatcher. Semi-Trailers, Low-boy Trucks, Asphalt Distributor Trucks, and Agitator, Mixer Trucks and dumpcrete type vehicles, Truck Mechanic, Fuel Truck.

GROUP 2: Specialized Earth Moving Equipment, Euclid type, or similar off-highway where not self-loading, Straddle (Ross) Carrier, and self-contained concrete mobile truck. Off-highway Tandem Back-Dump, Twin Engine Equipment and Double-Hitched Equipment where not self-loading.

Per hour:

07/01/2018

Heavy/Highway:

Group #1 \$ 25.82
Group #2 26.04

Additional \$1.50 per hour for hazardous waste removal work on a City, County, and/or Federal Designated waste site and regulations require employee to use or wear respiratory protection.

For work bid on or after April 1, 1982 there shall be a 12 month carryover of the negotiated rate in effect at the time of the bid.

SUPPLEMENTAL BENEFITS

Per hour:

All classes \$ 23.52

OVERTIME PAY

See (B, E, Q) on OVERTIME PAGE

HOLIDAY

Paid: See (5, 6) on HOLIDAY PAGE
Overtime: See (5, 6) on HOLIDAY PAGE

NOTE: If a holiday falls on a Sunday, it will be celebrated on Monday.

7-687

Welder

12/01/2018

JOB DESCRIPTION Welder

DISTRICT 1

ENTIRE COUNTIES

Albany, Allegany, Bronx, Broome, Cattaraugus, Cayuga, Chautauqua, Chemung, Chenango, Clinton, Columbia, Cortland, Delaware, Dutchess, Erie, Essex, Franklin, Fulton, Genesee, Greene, Hamilton, Herkimer, Jefferson, Kings, Lewis, Livingston, Madison, Monroe, Montgomery, Nassau, New York, Niagara, Oneida, Onondaga, Ontario, Orange, Orleans, Oswego, Otsego, Putnam, Queens, Rensselaer, Richmond, Rockland, Saratoga, Schenectady, Schoharie, Schuyler, Seneca, St. Lawrence, Steuben, Suffolk, Sullivan, Tioga, Tompkins, Ulster, Warren, Washington, Wayne, Westchester, Wyoming, Yates

WAGES

Per hour 07/01/2018

Welder: To be paid the same rate of the mechanic performing the work.*

*EXCEPTION: If a specific welder certification is required, then the 'Certified Welder' rate in that trade tag will be paid.

OVERTIME PAY

HOLIDAY

1-As Per Trade

Overtime Codes

Following is an explanation of the code(s) listed in the OVERTIME section of each classification contained in the attached schedule. Additional requirements may also be listed in the HOLIDAY section.

NOTE: Supplemental Benefits are 'Per hour worked' (for each hour worked) unless otherwise noted

- (AA) Time and one half of the hourly rate after 7 and one half hours per day
- (A) Time and one half of the hourly rate after 7 hours per day
- (B) Time and one half of the hourly rate after 8 hours per day
- (B1) Time and one half of the hourly rate for the 9th & 10th hours week days and the 1st 8 hours on Saturday.
Double the hourly rate for all additional hours
- (B2) Time and one half of the hourly rate after 40 hours per week
- (C) Double the hourly rate after 7 hours per day
- (C1) Double the hourly rate after 7 and one half hours per day
- (D) Double the hourly rate after 8 hours per day
- (D1) Double the hourly rate after 9 hours per day
- (E) Time and one half of the hourly rate on Saturday
- (E1) Time and one half 1st 4 hours on Saturday; Double the hourly rate all additional Saturday hours
- (E2) Saturday may be used as a make-up day at straight time when a day is lost during that week due to inclement weather
- (E3) Between November 1st and March 3rd Saturday may be used as a make-up day at straight time when a day is lost during that week due to inclement weather, provided a given employee has worked between 16 and 32 hours that week
- (E4) Saturday and Sunday may be used as a make-up day at straight time when a day is lost during that week due to inclement weather
- (E5) Double time after 8 hours on Saturdays
- (F) Time and one half of the hourly rate on Saturday and Sunday
- (G) Time and one half of the hourly rate on Saturday and Holidays
- (H) Time and one half of the hourly rate on Saturday, Sunday, and Holidays
- (I) Time and one half of the hourly rate on Sunday
- (J) Time and one half of the hourly rate on Sunday and Holidays
- (K) Time and one half of the hourly rate on Holidays
- (L) Double the hourly rate on Saturday
- (M) Double the hourly rate on Saturday and Sunday
- (N) Double the hourly rate on Saturday and Holidays
- (O) Double the hourly rate on Saturday, Sunday, and Holidays
- (P) Double the hourly rate on Sunday
- (Q) Double the hourly rate on Sunday and Holidays
- (R) Double the hourly rate on Holidays
- (S) Two and one half times the hourly rate for Holidays, if worked

- (S1) Two and one half times the hourly rate the first 8 hours on Sunday or Holidays One and one half times the hourly rate all additional hours.
- (T) Triple the hourly rate for Holidays, if worked
- (U) Four times the hourly rate for Holidays, if worked
- (V) Including benefits at SAME PREMIUM as shown for overtime
- (W) Time and one half for benefits on all overtime hours.
- (X) Benefits payable on Paid Holiday at straight time. If worked, additional benefit amount will be required for worked hours. (Refer to other codes listed.)

Holiday Codes

PAID Holidays:

Paid Holidays are days for which an eligible employee receives a regular day's pay, but is not required to perform work. If an employee works on a day listed as a paid holiday, this remuneration is in addition to payment of the required prevailing rate for the work actually performed.

OVERTIME Holiday Pay:

Overtime holiday pay is the premium pay that is required for work performed on specified holidays. It is only required where the employee actually performs work on such holidays. The applicable holidays are listed under HOLIDAYS: OVERTIME. The required rate of pay for these covered holidays can be found in the OVERTIME PAY section listings for each classification.

Following is an explanation of the code(s) listed in the HOLIDAY section of each classification contained in the attached schedule. The Holidays as listed below are to be paid at the wage rates at which the employee is normally classified.

- (1) None
- (2) Labor Day
- (3) Memorial Day and Labor Day
- (4) Memorial Day and July 4th
- (5) Memorial Day, July 4th, and Labor Day
- (6) New Year's, Thanksgiving, and Christmas
- (7) Lincoln's Birthday, Washington's Birthday, and Veterans Day
- (8) Good Friday
- (9) Lincoln's Birthday
- (10) Washington's Birthday
- (11) Columbus Day
- (12) Election Day
- (13) Presidential Election Day
- (14) 1/2 Day on Presidential Election Day
- (15) Veterans Day
- (16) Day after Thanksgiving
- (17) July 4th
- (18) 1/2 Day before Christmas
- (19) 1/2 Day before New Years
- (20) Thanksgiving
- (21) New Year's Day
- (22) Christmas
- (23) Day before Christmas
- (24) Day before New Year's
- (25) Presidents' Day
- (26) Martin Luther King, Jr. Day
- (27) Memorial Day
- (28) Easter Sunday



**New York State Department of Labor - Bureau of Public Work
State Office Building Campus
Building 12 - Room 130
Albany, New York 12240**

REQUEST FOR WAGE AND SUPPLEMENT INFORMATION

As Required by Articles 8 and 9 of the NYS Labor Law

Fax (518) 485-1870 or mail this form for new schedules or for determination for additional occupations.

This Form Must Be Typed

Submitted By: _____

(Check Only One)

- Contracting Agency Architect or Engineering Firm Public Work District Office

Date: _____

A. Public Work Contract to be let by: (Enter Data Pertaining to Contracting/Public Agency)

1. Name and complete address (Check if new or change)

Telephone: ()

Fax: ()

E-Mail: _____

2. NY State Units (see Item 5)

- | | |
|---|--|
| <input type="checkbox"/> 01 DOT | <input type="checkbox"/> 07 City |
| <input type="checkbox"/> 02 OGS | <input type="checkbox"/> 08 Local School District |
| <input type="checkbox"/> 03 Dormitory Authority | <input type="checkbox"/> 09 Special Local District, i.e.,
Fire, Sewer, Water District |
| <input type="checkbox"/> 04 State University
Construction Fund | <input type="checkbox"/> 10 Village |
| <input type="checkbox"/> 05 Mental Hygiene
Facilities Corp. | <input type="checkbox"/> 11 Town |
| <input type="checkbox"/> 06 OTHER N.Y. STATE UNIT | <input type="checkbox"/> 12 County |
| | <input type="checkbox"/> 13 Other Non-N.Y. State
(Describe) |

3. SEND REPLY TO check if new or change)
Name and complete address: _____

Telephone:()

Fax: ()

E-Mail: _____

4. SERVICE REQUIRED. Check appropriate box and provide project information.

New Schedule of Wages and Supplements.

APPROXIMATE BID DATE : _____

Additional Occupation and/or Redetermination

PRC NUMBER ISSUED PREVIOUSLY FOR
THIS PROJECT : _____

OFFICE USE ONLY

B. PROJECT PARTICULARS

5. Project Title _____

Description of Work _____

Contract Identification Number _____

Note: For NYS units, the OSC Contract No. _____

6. Location of Project:
Location on Site _____

Route No/Street Address _____

Village or City _____

Town _____

County _____

7. Nature of Project - Check One:

- 1. New Building
- 2. Addition to Existing Structure
- 3. Heavy and Highway Construction (New and Repair)
- 4. New Sewer or Waterline
- 5. Other New Construction (Explain)
- 6. Other Reconstruction, Maintenance, Repair or Alteration
- 7. Demolition
- 8. Building Service Contract

8. OCCUPATION FOR PROJECT :

- | | |
|--|---|
| <input type="checkbox"/> Construction (Building, Heavy
Highway/Sewer/Water) | <input type="checkbox"/> Guards, Watchmen |
| <input type="checkbox"/> Tunnel | <input type="checkbox"/> Janitors, Porters, Cleaners,
Elevator Operators |
| <input type="checkbox"/> Residential | <input type="checkbox"/> Moving furniture and
equipment |
| <input type="checkbox"/> Landscape Maintenance | <input type="checkbox"/> Trash and refuse removal |
| <input type="checkbox"/> Elevator maintenance | <input type="checkbox"/> Window cleaners |
| <input type="checkbox"/> Exterminators, Fumigators | <input type="checkbox"/> Other (Describe) |
| <input type="checkbox"/> Fire Safety Director, NYC Only | |

9. Has this project been reviewed for compliance with the Wicks Law involving separate bidding? YES NO

10. Name and Title of Requester _____

Signature



NEW YORK STATE DEPARTMENT OF LABOR
Bureau of Public Work - Debarment List

**LIST OF EMPLOYERS INELIGIBLE TO BID ON OR BE
AWARDED ANY PUBLIC WORK CONTRACT**

Under Article 8 and Article 9 of the NYS Labor Law, a contractor, sub-contractor and/or its successor shall be debarred and ineligible to submit a bid on or be awarded any public work or public building service contract/sub-contract with the state, any municipal corporation or public body for a period of five (5) years from the date of debarment when:

- Two (2) final determinations have been rendered within any consecutive six-year (6) period determining that such contractor, sub-contractor and/or its successor has WILLFULLY failed to pay the prevailing wage and/or supplements;
- One (1) final determination involves falsification of payroll records or the kickback of wages and/or supplements.

The agency issuing the determination and providing the information, is denoted under the heading 'Fiscal Officer'. DOL = New York State Department of Labor; NYC = New York City Comptroller's Office; AG = New York State Attorney General's Office; DA = County District Attorney's Office.

Debarment Database: To search for contractors, sub-contractors and/or their successors debarred from bidding or being awarded any public work contract or subcontract under NYS Labor Law Articles 8 and 9, or under NYS Workers' Compensation Law Section 141-b, access the database at this link: <https://applications.labor.ny.gov/EDList/searchPage.do>

For inquiries where WCB is listed as the "Agency", please call 1-866-546-9322

NYSDOL Bureau of Public Work Debarment List 12/11/2018

Article 9

AGENCY	Fiscal Officer	FEIN	EMPLOYER NAME	EMPLOYER DBA NAME	ADDRESS	DEBARMENT START DATE	DEBARMENT END DATE
DOL	DOL	****0996	A-1 CONSTRUCTION & RENOVATION INC		1973 81ST ST - SUITE A-5 BROOKLYN NY 11214	01/08/2015	01/08/2020
DOL	NYC		ABDUL KARIM		C/O NORTH AMERICAN IRON W 1560 DECATUR STREETRIDGWOOD NY 11385	05/15/2015	05/15/2020
DOL	DOL	****8018	ACCURATE MECHANICAL LLC		9547 BUSTLETON AVENUE PHILADELPHIA PA 19115	02/05/2014	02/05/2019
DOL	DOL		ACCURATE MECHANICAL OF PHILADELPHIA LLC		9547 BUSTLETON AVENUE PHILADELPHIA PA 19115	02/05/2014	02/05/2019
DOL	DOL	****3344	ACT INC		6409 LAND O LAKES BLVD LAND O LAKES FL 34638	11/10/2015	11/10/2020
DOL	NYC		ADRIANA SELA	C/O COLONIAL ROOFING COMPANY INC	247 48TH STREET BROOKLYN NY 11220	02/05/2014	02/05/2019
DOL	DOL	****1687	ADVANCED SAFETY SPRINKLER INC		261 MILL ROAD P O BOX 296EAST AURORA NY 14052	07/29/2015	07/29/2020
DOL	NYC	****6775	ADVENTURE MASONRY CORP.		1535 RICHMOND AVENUE STATEN ISLAND NY 10314	12/13/2017	12/13/2022
DOL	DOL		AJ TORCHIA		10153 ROBERTS RD SAUQUOIT NY 13456	08/09/2016	08/09/2021
DOL	DOL	****3344	ALL CATASTROPHE CONSTRUCTION TEAM INC	ACT INC	6409 LAND O LAKES BLVD LAND O LAKES FL 34638	11/10/2015	11/10/2020
DOL	DOL	****8740	ALLSTATE ENVIRONMENTAL CORP		C/O JOSE MONTAS 27 BUTLER PLACEYONKERS NY 10710	03/18/2011	03/19/2020
DOL	DOL		AMADEO J TORCHIA	TORCHIA'S HOME IMPROVEM T	10153 ROBERTS RD SAUQUOIT NY 13456	08/09/2016	08/09/2021
DOL	NYC		ANISUL ISLAM		C/O RELIANCE GENERAL CONS 644 OCEAN PARKWAYBROOKLYN NY 11230	09/02/2015	09/02/2020
DOL	DOL	****7004	ANNEX CONTRACTING LTD		3005 WYNSUM AVENUE MERRICK NY 11566	08/18/2014	08/18/2019
DOL	DOL	****7004	ANNEX GENERAL CONTRACTING INC		3005 WYNSUM AVENUE MERRICK NY 11566	08/18/2014	08/18/2019
DOL	DA		ANTHONY CARDINALE		58-48 59TH STREET MASPETH NY 11378	05/16/2012	05/08/2020
DOL	DOL		ANTHONY J MINGARELLI JR		C/O T & T CONCRETE INC 2560 HAMBURG TURNPIKELACKAWANNA NY 14218	07/08/2015	07/08/2020
DOL	DOL		ANTHONY PERGOLA		3 WEST MAIN ST/SUITE 208 ELMSFORD NY 10323	01/23/2017	01/23/2022
DOL	DOL		ANTONIO ESTIVEZ		442 ARMONK RD MOUNT KISCO NY 10549	06/12/2018	06/12/2023
DOL	DOL	****3020	APCO CONTRACTING CORP		24 SOUTH MARYLAND AVENUE PORT WASHINGTON NY 11050	09/24/2012	09/02/2020
DOL	DOL	****3219	APOLLO CONSTRUCTION SERVICES CORP	APOLLO PAINTING CO	157 TIBBETTS ROAD YONKERS NY 10705	03/12/2014	03/12/2019
DOL	DOL		APOLLO PAINTING CO		157 TIBBETTS ROAD YONKERS NY 10705	03/12/2014	03/12/2019
DOL	DOL	****3295	APOLLO PAINTING CORP		3 ALAN B SHEPART PLACE YONKERS NY 10705	03/12/2014	03/12/2019
DOL	NYC	****8403	AQUA JET PAINTING CORP		10 VIKING DRIVE WEST ISLIP NY 11795	04/16/2014	04/16/2019
DOL	NYC	****9232	ARKAY CONSTRUCTION INC		102-104 GREYLOCK AVENUE BELLEVILLE NJ 07109	07/15/2015	07/15/2020
DOL	NYC	****4779	ASTORIA GENERAL CONTRACTING CORP		35-34 31ST STREET LONG ISLAND CITY NY 11106	09/02/2015	09/02/2020
DOL	NYC	****7217	ASTRO COMMUNICATIONS OF NY CORP		79 ALEXANDER AVE- STE 36A BRONX NY 10454	10/30/2015	10/30/2020
DOL	NYC	****6046	ATLANTIC SUN CONSTRUCTION CORP		58-46 59TH AVENUE MASPETH NY 11378	05/08/2015	05/08/2020
DOL	NYC	****6683	ATLAS RESTORATION CORP.		35-12 19TH AVENUE ASTORIA NY 11105	08/02/2017	08/02/2022
DOL	NYC		AUDLEY O'BRIEN		1273 NORTH AVENUE/#1 CP NEW ROCHELLE NY 10804	04/07/2015	04/07/2020
DOL	NYC	****2591	AVI 212 INC.		260 CROPSY AVENUE APT 11GBROOKLYN NY 11214	10/30/2018	10/30/2023

NYSDOL Bureau of Public Work Debarment List 12/11/2018

Article 9

DOL	DOL		AVIS R HILL		3510 HICKORY WALK LANE ELLENWOOD GA 32094	01/22/2015	01/22/2020
DOL	AG		AVTAR SINGH		116-24 127TH STREET SOUTH OZONE PARK NY 11420	12/22/2015	12/22/2020
DOL	AG		BALDEV SINGH		116-24 127TH STREET SOUTH OZONE PARK NY 11420	12/22/2015	12/22/2020
DOL	DOL		BARBARA CASSIDY		7 BLENIS PLACE VALHALLA NY 10595	04/02/2015	04/02/2020
DOL	DOL		BARRY KINNEY		6409 LAND O LAKES BLVD LAND O LAKES FL 34638	11/10/2015	11/10/2020
DOL	NYC	****3915	BEACON RESTORATION INC		SUITE B-8 782 PELHAM PARKWAY SOUTHBRONX NY 10462	04/21/2016	04/21/2021
DOL	DOL		BIAGIO CANTISANI			06/12/2018	06/12/2023
DOL	DOL	****8551	BRANDY'S MASONRY		216 WESTBROOK STREET P O BOX 304SAYRE PA 18840	08/09/2016	08/09/2021
DOL	NYC	****6555	BROOKLYN WELDING CORP		1273 NORTH AVENUE/ #1 CP NEW ROCHELLE NY 10804	04/07/2015	04/07/2020
DOL	DOL	****1449	BRRESTORATION NY INC		140 ARCADIA AVENUE OSWEGO NY 13126	09/12/2016	09/12/2021
DOL	DOL		BRUCE MORSEY		C/O KENT HOLLOW SIDING LL 29A BRIDGE STREETNEW MILFORD CT 06776	01/15/2016	01/15/2021
DOL	DOL		BRUCE P. NASH JR.		5841 BUTTERNUT ROAD EAST SYRACUSE NY 13057	09/12/2018	09/12/2023
DOL	DOL	****6156	C & J LANDSCAPING & MAINTENANCE INC		520 PINE HILL ROAD CHESTER NY 10940	06/23/2014	06/23/2019
DOL	DOL	****8809	C.B.E. CONTRACTING CORPORATION		310 MCGUINNESS BLVD GREENPOINT NY 11222	03/07/2017	03/07/2022
DOL	DOL		CANTISANI & ASSOCIATES LTD		442 ARMONK RD MOUNT KISCO NY 10549	06/12/2018	06/12/2023
DOL	DOL		CANTISANI HOLDING LLC			06/12/2018	06/12/2023
DOL	DOL		CARIBBEAN POOLS		C/O DOUGLAS L MALARKEY 64 VICTORIA DRIVEBINGHAMTON NY 13904	02/04/2016	02/04/2021
DOL	DOL	****3812	CARMODY "2" INC			06/12/2018	06/12/2023
DOL	DOL	****1143	CARMODY BUILDING CORP	CARMODY CONTRACTIN G AND CARMODY CONTRACTIN G CORP.	442 ARMONK RD MOUNT KISCO NY 10549	06/12/2018	06/12/2023
DOL	DOL		CARMODY CONCRETE CORPORATION			06/12/2018	06/12/2023
DOL	DOL		CARMODY ENTERPRISES, LTD.		442 ARMONK RD MOUNT KISCO NY 10549	06/12/2018	06/12/2023
DOL	DOL		CARMODY INC		442 ARMONK RD MOUNT KISCO NY 10549	06/12/2018	06/12/2023
DOL	DOL	****3812	CARMODY INDUSTRIES INC			06/12/2018	06/12/2023
DOL	DOL		CARMODY MAINTENANCE CORPORATION		442 ARMONK RD MOUNT KISCO NY 10549	06/12/2018	06/12/2023
DOL	DOL		CARMODY MASONRY CORP		442 ARMONK RD MOUNT KISCO NY 10549	06/12/2018	06/12/2023
DOL	NYC	****9172	CASSIDY EXCAVATING INC		14 RAILROAD AVENUE VALHALLA NY 10595	05/15/2014	04/02/2020
DOL	DOL	****6745	CATSKILL FENCE INSTALLATIONS INC		5445 ROUTE 32 CATSKILL NY 12414	08/22/2014	08/22/2019
DOL	DOL	****8809	CBE CONTRACTING CORP		142 EAST MARKET STREET LONG BEACH NY 11561	03/07/2017	03/07/2022
DOL	AG		CESAR J. AGUDELO		81-06 34TH AVENUE APT. 6EJACKSON HEIGHTS NY 11372	02/07/2018	02/07/2023
DOL	DOL	****7655	CHAMPION CONSTRUCTION SERVICES CORP		2131 SCHENECTADY AVENUE BROOKLYN NY 11234	11/18/2015	11/18/2020
DOL	NYC		CHARLES CASSIDY JR		14 RAILROAD AVENUE VALHALLA NY 10595	05/15/2014	04/02/2020
DOL	DOL		CHARLES ZIMMER JR		216 WESTBROOK STREET P O BOX 304SAYRE PA 18840	08/09/2016	08/09/2021
DOL	DOL		CHRISTINE J HEARNE		C/O CJ-HEARNE CONSTRUCTIO 131 PONCE DE LEON AVE NEATLANTA GA 30308	12/01/2015	12/01/2020

NYS DOL Bureau of Public Work Debarment List 12/11/2018

Article 9

DOL	DOL		CHRISTOPHER J MAINI		19 CAITLIN AVE JAMESTOWN NY 14701	09/17/2018	09/17/2023
DOL	DOL	****3360	CITY LIMITS GROUP INC		2279 HOLLERS AVENUE BRONX NY 10475	01/07/2014	06/23/2019
DOL	DOL	****0671	CJ-HEARNE CONSTRUCTION CO		SUITE 204 131 PONCE DE LEON AVENUE ATLANTA GA 30308	12/01/2015	12/01/2020
DOL	NYC	****2905	COLONIAL ROOFING COMPANY INC		247 48TH STREET BROOKLYN NY 11220	02/05/2014	02/05/2019
DOL	DOL	****2703	CONKLIN'S TECH- MECHANICAL INC		5 PARKER AVENUE POUGHKEEPSIE NY 12601	03/25/2014	03/25/2019
DOL	DOL	****1927	CONSTRUCTION PARTS WAREHOUSE, INC.	CPW	5841 BUTTERNUT ROAD EAST SYRACUSE NY 13057	09/12/2018	09/12/2023
DOL	NYC	****4468	CRAFT CONTRACTING GROUP INC		3256 BRUNER AVENUE BRONX NY 10469	07/29/2014	07/29/2019
DOL	NYC	****8507	CRAFT FENCE INC		3256 BRUNER AVENUE BRONX NY 10469	07/29/2014	07/29/2019
DOL	NYC	****2164	CREATIVE TRUCKING INC		58-83 54TH STREET MASPETH NY 11378	02/26/2016	02/26/2021
DOL	DOL	****7761	D L MALARKEY CONSTRUCTION		64 VICTORIA DRIVE BINGHAMTON NY 13904	02/04/2016	02/04/2021
DOL	DOL	****7888	D L MALARKEY CONSTRUCTION INC		64 VICTORIA DRIVE BINGHAMTON NY 13904	02/04/2016	02/04/2021
DOL	DOL	****5629	DAKA PLUMBING AND HEATING LLC		2561 ROUTE 55 POUGHQUAG NY 12570	02/19/2016	02/19/2021
DOL	DOL		DANICA IVANOSKI		61 WILLET ST. PASSAIC NJ 07503	10/26/2016	10/26/2021
DOL	DOL		DARYL T RIEKS		C/O RIEKS CONTRACTING LLC 4804 GAHWILER ROAD AUBURN NY 13021	05/01/2015	05/01/2020
DOL	NYC	****7707	DASSLE CONTRACTING INC		213-37 39TH AVE/SUITE 120 BAYSIDE NY 11360	05/08/2015	05/08/2020
DOL	DOL		DAVID MARTINEZ		C/O EMPIRE TILE INC 6 TREMONT COURTHUNTINGTON STATION NY 11746	03/08/2016	03/08/2021
DOL	NYC		DAWN AVILA AKA DAWN BECHTOLD		1ST FLOOR STORE FRONT 88-10 LITTLE NECK PARKWAY FLORAL PARK NY 11001	06/24/2014	06/24/2019
DOL	NYC		DAWN BECHTOLD AKA DAWN AVILA		1ST FLOOR STORE FRONT 88-10 LITTLE NECK PARKWAY FLORAL PARK NY 11001	06/24/2014	06/24/2019
DOL	DOL		DEBBIE STURDEVANT		29 MAPLEWOOD DRIVE BINGHAMTON NY 13901	02/21/2017	02/21/2022
DOL	AG		DEBRA MARTINEZ		31 BAY ST BROOKLYN NY 11231	03/28/2018	03/28/2023
DOL	NYC	****3865	DECOMA BUILDING CORPORATION		134 EVERGREEN PL/STE 101 EAST ORANGE NJ 07018	12/30/2013	12/30/2018
DOL	DOL		DEDA GAZIVODAN		C/O DAKA PLUMBING AND H 2561 ROUTE 55 POUGHQUAG NY 12570	02/19/2016	02/19/2021
DOL	DOL		DENNIS SCHWANDTNER		C/O YES SERVICE AND REPAIR 145 LODGE AVE HUNTINGTON STATION NY 11476	08/09/2016	08/09/2021
DOL	DOL		DF CONTRACTORS OF ROCHESTER, INC.		1835 DAANSEN RD. PALMYRA NY 14522	05/16/2017	05/16/2022
DOL	DOL		DF CONTRACTORS, INC.		1835 DAANSEN RD. PALMYRA NY 14522	05/16/2017	05/16/2022
DOL	DOL	****9252	DI BERNARDO TILE AND MARBLE CO INC		15 WALKER WAY ALBANY NY 12205	03/21/2014	03/21/2019
DOL	NYC		DIMITRIOS KOUTSOUKOS		C/O ASTORIA GENERAL CONTR 35-34 31ST STREET LONG ISLAND CITY NY 11106	09/02/2015	09/02/2020
DOL	NYC		DIMITRIOS TSOUMAS		35-12 19TH AVENUE ASTORIA NY 11105	08/02/2017	08/02/2022
DOL	DOL	****3242	DONALD R. FORSAY	DF LAWN SERVICE	1835 DAANSEN RD. PALMYRA NY 14522	05/16/2017	05/16/2022
DOL	DOL		DONALD R. FORSAY		1835 DAANSEN RD. PALMYRA NY 14522	05/16/2017	05/16/2022
DOL	DOL		DORIS SKODA		C/O APCO CONTRACTING CORP 24 SOUTH MARYLAND AVENUE PORT WASHINGTON NY 11050	09/24/2012	09/02/2020
DOL	NYC	****7404	DOSANJH CONSTRUCTION CORP		9439 212TH STREET QUEENS VILLAGE NY 11428	02/25/2016	02/25/2021

NYS DOL Bureau of Public Work Debarment List 12/11/2018

Article 9

DOL	DOL		DOUGLAS L MALARKEY	MALARKEY CONSTRUCTION	64 VICTORIA DRIVE B INGHAMTON NY 13904	02/04/2016	02/04/2021
DOL	DOL	****6982	DUFOUR GROUP INC	DUFOUR MASONRY	353 WEST 56TH STREET #7M NEW YORK NY 10019	06/10/2014	06/10/2019
DOL	DOL		DUFOUR MASONRY		353 WEST 56TH ST #7M NEW YORK NY 10019	06/10/2014	06/10/2019
DOL	DOL		DUFOUR MASONRY & RESTORATION INC		123 ALBANY NY	06/10/2014	06/10/2019
DOL	DOL		E C WEBB		6409 LAND O LAKES BLVD LAND O LAKES FL 34638	11/10/2015	11/10/2020
DOL	DOL		EARL L WILSON	WILSON BROTHER DRYWALL CONTRACTORS	36 ABERSOLD STREET ROCHESTER NY 14621	08/31/2015	08/31/2020
DOL	DOL		EAST COAST PAVING		2238 BAKER RD GILLET PA 16923	03/12/2018	03/12/2023
DOL	NYC		EDWARD MENKEN		C/O AQUA JET PAINTING 10 VIKING DRIVE WEST ISLIP NY 11795	04/16/2014	04/16/2019
DOL	NYC	****0900	EF PRO CONTRACTING INC		147 BROOME AVENUE ATLANTIC BEACH NY 11509	03/03/2014	03/03/2019
DOL	NYC		EFSTRATIOS BERNARDIS		23-73 48TH STREET LONG ISLAND CITY NY 11103	04/24/2014	04/24/2019
DOL	DOL		ELIZABETH RAMADANI		C/O RAMADA CONSTRUCTION 80 SAVO LOOPSTATEN ISLAND NY 10309	01/07/2014	01/07/2019
DOL	DOL	****0780	EMES HEATING & PLUMBING CONTR		5 EMES LANE MONSEY NY 10952	01/20/2002	01/20/3002
DOL	AG		EMILIO FRANZA		90 JUNIUS STREET BROOKLYN NY 11212	01/23/2014	01/23/2019
DOL	DOL		EMPIRE CONCRETE SERVICES LLC		101 SULLYS TRAIL/SUITE 20 PITTSFORD NY 14534	11/18/2013	01/07/2019
DOL	DOL	****0511	EMPIRE CONCRETE SYSTEMS LLC		101 SULLYS TRAIL/ SUITE 2 PITTSFORD NY 14534	11/18/2013	01/07/2019
DOL	DOL	****2353	EMPIRE CONSTRUCTORS LLC		101 SULLYS TRAIL/SUITE 20 PITTSFORD NY 14534	11/18/2013	01/07/2019
DOL	DOL		EMPIRE PRECAST LLC		101 SULLYS TRAIL/SUITE 20 PITTSFORD NY 14534	11/18/2013	01/07/2019
DOL	DOL	****3270	EMPIRE TILE INC		6 TREMONT COURT HUNTINGTON STATION NY 11746	03/08/2016	03/08/2021
DOL	NYC		EVERTON CARLESS		134 EVERGREEN PL/STE 101 EAST ORANGE NJ 07018	12/30/2013	12/30/2018
DOL	DOL	****7403	F & B PAINTING CONTRACTING INC		2 PARKVIEW AVENUE HARRISON NY 10604	09/26/2016	09/26/2021
DOL	DOL		F KALAFATIS		2279 HOLLERS AVENUE BRONX NY 10475	01/07/2014	06/23/2019
DOL	DOL		FAY MATTHEW		C/O CHAMPION CONSTRUCTION 2131 SCHENECTADY AVENUE BROOKLYN NY 11234	11/18/2015	11/18/2020
DOL	DOL		FAZIA GINA ALI-MOHAMMED	C/O CHAMPION CONSTRUCTION	2131 SCHENECTADY AVENUE BROOKLYN NY 11234	11/18/2015	11/18/2020
DOL	DOL		FRAN MICELI		2279 HOLLERS AVENUE BRONX NY 10475	01/07/2014	06/23/2019
DOL	DOL		FRANCES KALAFATIS		2279 HOLLERS AVENUE BRONX NY 10475	01/07/2014	06/23/2019
DOL	DOL		FRANCES KALAFATIS-MICELI		2279 HOLLERS AVENUE BRONX NY 10475	01/07/2014	06/23/2019
DOL	DOL		FRANK BENEDETTO		19 CATLIN AVE JAMESTOWN NY 14701	09/17/2018	09/17/2023
DOL	DOL		FRANK BENEDETTO		C/O F & B PAINTING CONTRA 2 PARKVIEW AVENUE HARRISON NY 10604	09/26/2016	09/26/2021
DOL	DOL	****4722	FRANK BENEDETTO AND CHRISTOPHER J MAINI	B & M CONCRETE	19 CAITLIN AVE JAMESTOWN NY 14701	09/17/2018	09/17/2023
DOL	DOL		FRANK DEMARTINO		101-61 99TH STREET OZONE PARK NY 11416	02/15/2017	02/15/2022
DOL	DOL		FRANK DEMARTINO		101-61 99TH STREET OZONE PARK NY 11416	02/15/2017	02/15/2022
DOL	DOL		FRANK J MERCANDO		134 MURRAY AVENUE YONKERS NY 10704	12/11/2009	02/03/2019
DOL	DOL	****2724	FRESH START PAINTING CORP		157 TIBBETS ROAD YONKERS NY 10705	03/12/2014	03/12/2019

NYS DOL Bureau of Public Work Debarment List 12/11/2018

Article 9

DOL	DOL		G FUCCI CONSTRUCTION SERVICES		3 ALAN B SHEPARD PLACE YONKERS NY 10705	03/12/2014	03/12/2019
DOL	DOL	****6767	G FUCCI PAINTING INC		C/O SPIEGEL & UTRERA 1 MAIDEN LANE - 5TH FL NEW YORK NY 10038	03/12/2014	03/12/2019
DOL	DOL	****4546	GAF PAINTING LLC		157 TIBBETS ROAD YONKERS NY 10705	03/12/2014	03/12/2019
DOL	DOL		GALINDA ROTENBERG		C/O GMDV TRANS INC 67-48 182ND STREET FRESH MEADOWS NY 11365	06/24/2016	06/24/2021
DOL	DOL		GARDEN STATE PAINTING		157 TIBBETS ROAD YONKERS NY 10705	03/12/2014	03/12/2019
DOL	DOL		GEOFF CORLETT		415 FLAGGER AVE #302STUART FL 34994	10/31/2018	10/31/2023
DOL	DOL		GEORGE DI BERNARDO		C/O DI BERNARDO TILE 15 WALKER WAY ALBANY NY 12205	03/21/2014	03/21/2019
DOL	DA		GEORGE LUCEY		150 KINGS STREET BROOKLYN NY 11231	01/19/1998	01/19/2998
DOL	DOL	****5674	GMDV TRANS INC		67-48 182ND STREET FRESH MEADOWS NY 11365	06/24/2016	06/24/2021
DOL	NYC		GREAT ESTATE CONSTRUCTION, INC.		327 STAGG ST BROOKLYN NY 11206	10/10/2017	10/10/2022
DOL	DOL		GREGORY A FUCCI		C/O PAF PAINTING SERVICES 157 TIBBETS ROAD YONKERS NY 10705	03/12/2014	03/12/2019
DOL	DOL		GREGORY FUCCI JR		C/O APOLLO CONSTRUCTION 157 TIBBETS ROAD YONKERS NY 10705	03/12/2014	03/12/2019
DOL	DOL		GREGORY S. OLSON		P. O BOX 100 200 LATTA BROOK PARKHORSEHEADS NY 14845	03/08/2018	03/08/2023
DOL	NYC	****0346	H N H CONTRACTORS CORP		4558 BROADWAY # 6 NEW YORK NY 10040	08/04/2014	08/04/2019
DOL	NYC		HAMEEDUL HASAN		240 HOME STREET TEANECK NJ 07666	08/04/2014	08/04/2019
DOL	NYC		HARMEL SINGH		15 CLINTON LANE HICKSVILLE NY 11801	02/25/2016	02/25/2021
DOL	NYC		HAROLD KUEMMEL		58-83 54TH STREET MASPETH NY 11378	02/26/2016	02/26/2021
DOL	AG		HARVINDER SINGH PAUL		90 JUNIUS STREET BROOKLYN NY 11212	01/23/2014	01/23/2019
DOL	DOL		HENRY VAN DALRYMPLE		2663 LANTERN LANE ATLANTA GA 30349	12/01/2015	12/01/2020
DOL	DOL	****6370	HILLIANO CONSTRUCTION & ELECTRICAL INC		354 MAGNOLIA STREET ROCHESTER NY 14611	01/22/2015	01/22/2020
DOL	DOL	****8282	IDEMA DEVELOPMENT INC		91 COLLEGE AVENUE POUGHKEEPSIE NY 12603	12/04/2015	12/04/2020
DOL	DOL	****8282	IDEMA GENERAL CONTRACTORS INC		91 COLLEGE AVENUE POUGHKEEPSIE NY 12603	12/04/2015	12/04/2020
DOL	DOL	****7001	INTEGRATED CONSTRUCTION & POWER SYSTEMS INC		SUITE 100 2105 W GENESEE STREETS YRACUSE NY 13219	01/06/2016	01/06/2021
DOL	DOL	****5131	INTEGRITY MASONRY, INC.	M&R CONCRETE	722 8TH AVE WATERVLIET NY 12189	06/05/2018	06/05/2023
DOL	AG		J A M CONSTRUCTION CORP		SUITE 125 265 SUNRISE HIGHWAY ROCKVILLE CENTRE NY 10457	04/07/2016	04/07/2021
DOL	DOL	****7598	J M RICH LLC		P O BOX 268 STILLWATER NY 12170	09/16/2013	03/21/2019
DOL	DOL	****3478	J N P CONSTRUCTION CORP		50 LOUIS COURT P O BOX 1907 SOUTH HACKENSACK NY 07606	03/21/2014	03/21/2019
DOL	DOL		J N RICH LLC		P O BOX 268 STILLWATER NY 12170	09/16/2013	03/21/2019
DOL	DOL	****4910	J V MAGIC TOUCH CORPORATION		94-25 57TH AVENUE, APT 5G ELMHURST NY 11373	01/12/2015	01/12/2020
DOL	DOL		J.A. HIRES CADWALLADER		P.O BOX 100 200 LATTA BROOK PARKHORSEHEADS NY 14845	03/08/2018	03/08/2023
DOL	DOL		JAMES B RHYNDERS		91 COLLEGE AVENUE POUGHKEEPSIE NY 12603	12/04/2015	12/04/2020
DOL	DOL		JAMES BOYCE		C/O EMPIRE CONCRETE SYST 101 SULLYS TRAIL/SUITE 20 PITTSFORD NY 14534	11/18/2013	01/07/2019
DOL	DOL		JAMES C. DELGIACCO		722 8TH AVE WATERVLIET NY 12189	06/05/2018	06/05/2023

NYS DOL Bureau of Public Work Debarment List 12/11/2018

Article 9

DOL	DOL		JAMES E RHYNDERS		91 COLLEGE AVENUE POUGHKEEPSIE NY 12603	12/04/2015	12/04/2020
DOL	AG		JAMES FALCONE		SUITE 125 265 SUNRISE HIGHWAY ROCKVILLE CENTRE NY 10457	04/07/2016	04/07/2021
DOL	DOL		JAMES LIACONE		9365 WASHINGTON ST LOCKPORT IL 60441	07/23/2018	07/23/2023
DOL	DOL		JAMES RACHEL		9365 WASHINGTON ST LOCKPORT IL 60441	07/23/2018	07/23/2023
DOL	DOL		JAMES RHYNDERS SR		91 COLLEGE AVENUE POUGHKEEPSIE NY 12603	12/04/2015	12/04/2020
DOL	DOL		JAMES SICKAU		3090 SHIRLEY ROAD NORTH COLLINS NY 14111	04/19/2011	07/08/2020
DOL	DOL		JASON M RICH		P O BOX 268 STILLWATER NY 12170	09/16/2013	03/21/2019
DOL	DOL		JASON W MILLIMAN		C/O ROCHESTER ACOUSTICAL P O BOX 799 HILTON NY 14468	02/19/2016	02/19/2021
DOL	DOL	*****5368	JCH MASONRY & LANDSCAPING INC.		35 CLINTON AVE OSSINING NY 10562	09/12/2018	09/12/2023
DOL	DOL		JEFF P BRADLEY		520 PINE HILL ROAD CHESTER NY 10940	06/23/2014	06/23/2019
DOL	NYC		JEFFREY CASSIDY		14 RAILROAD AVENUE VALHALLA NY 10595	05/15/2014	04/02/2020
DOL	DOL		JEROME LACITIGNOLA		C/O CATSKILL FENCE INSTAL 5445 ROUTE 32 CATSKILL NY 12414	08/22/2014	08/22/2019
DOL	DOL		JESSICA WHITESIDE		C/O BRRESTORATION NY INC 140 ARCADIA AVENUE OSWEGO NY 13126	09/12/2016	09/12/2021
DOL	AG		JOHN ANTHONY MASSINO		36-49 204TH STREET BAYSIDE NY 11372	02/07/2018	02/07/2023
DOL	DOL		JOHN F. CADWALLADER		200 LATTA BROOK PARK HORSEHEADS NY 14845	03/08/2018	03/08/2023
DOL	DOL	*****4612	JOHN F. CADWALLADER, INC.	THE GLASS COMPANY	P.O BOX 100 200 LATTA BROOK PARK HORSEHEADS NY 14845	03/08/2018	03/08/2023
DOL	AG	*****0600	JOHNCO CONTRACTING, INC.		36-49 204TH STREET BAYSIDE NY 11372	02/07/2018	02/07/2023
DOL	DOL		JON E DEYOUNG		261 MILL ROAD P O BOX 296 EAST AURORA NY 14052	07/29/2015	07/29/2020
DOL	DOL		JORGE VILLALOBOS		94-25 57TH AVENUE - APT 5 ELMHURST NY 11373	01/12/2015	01/12/2020
DOL	DOL		JORI PEDERSEN		415 FLAGER AVE #302 STUART FL 34994	10/31/2018	10/31/2023
DOL	DOL		JOSE CHUCHUCA		35 CLINTON AVE OSSINING NY 10562	09/12/2018	09/12/2023
DOL	DOL		JOSE MONTAS		27 BUTLER PLACE YONKERS NY 10710	03/18/2011	03/19/2020
DOL	AG		JOSEPH FALCONE		SUITE 125 265 SUNRISE HIGHWAY ROCKVILLE CENTRE NY 10457	04/07/2016	04/07/2021
DOL	DOL	*****9273	JOSEPH M LOVETRO		P O BOX 812 BUFFALO NY 14220	08/09/2016	08/09/2021
DOL	NYC		JOSEPH MARTINO		1535 RICHMOND AVENUE STATEN ISLAND NY 10314	12/13/2017	12/13/2022
DOL	DOL		JOSHUA DEBOWSKY		9547 BUSTLETON AVENUE PHILADELPHIA PA 19115	02/05/2014	02/05/2019
DOL	DOL		JUANA MARTINEZ		C/O LEAD CONSTRUCTION 27 BUTLER PLACE YONKERS NY 10710	03/19/2015	03/19/2020
DOL	DOL	*****4340	JUBCO SITE DEVELOPMENT LLC		462 LAKEVIEW AVENUE VALHALLA NY 10595	12/16/2013	12/16/2018
DOL	DOL		JULIUS AND GITA BEHREND		5 EMES LANE MONSEY NY 10952	11/20/2002	11/20/3002
DOL	DOL	*****5062	K R F SITE DEVELOPMENT INC		375 LAKE SHORE DRIVE PUTNAM VALLEY NY 10579	01/23/2017	01/23/2022
DOL	NYC		KATHLEEN SELA	C/O COLONIAL ROOFING COMPANY INC	247 48TH STREET BROOKLYN NY 11220	02/05/2014	02/05/2019
DOL	DOL		KATIE BURDICK		2238 BAKER RD GILLET PA 16923	03/12/2018	03/12/2023
DOL	DOL		KENNETH FIORENTINO		375 LAKE SHORE DRIVE PUTNAM VALLEY NY 10579	01/23/2017	01/23/2022

NYS DOL Bureau of Public Work Debarment List 12/11/2018

Article 9

DOL	DOL	****9732	KENT HOLLOW SIDING LLC		29A BRIDGE STREET NEW MILFORD CT 06776	01/15/2016	01/15/2021
DOL	DOL		KEVIN BABCOCK JR		P O BOX 46 THOMPSON RIDGE NY 10985	08/22/2014	08/22/2019
DOL	DOL		KEVIN M BABCOCK		P O BOX 46 THOMPSON RIDGE NY 10985	08/22/2014	08/22/2019
DOL	DOL		KIM SOROCENSKI		C/O SOLUTION MATTERS INC 198 NORWOOD ROADPORT JEFFERSON NY 11776	11/19/2015	11/19/2020
DOL	DOL	****3490	L & M CONSTRUCTION/DRYWALL INC.		1079 YONKERS AVE YONKERS NY 10704	08/07/2018	08/07/2023
DOL	DA	****8816	LAKE CONSTRUCTION AND DEVELOPMENT CORPORATION		150 KINGS STREET BROOKLYN NY 11231	08/19/1998	08/19/2998
DOL	DOL	****6224	LAKESIDE FIRE SPRINKLERS LLC		125 CHAUTAUQUA AVENUE LAKEWOOD NY 14750	06/24/2015	06/24/2020
DOL	AG	****4643	LALO DRYWALL, INC.		221 OLD FORD ROAD NEW PLATZ NY 12561	05/20/2016	05/20/2021
DOL	DOL	****4505	LARAPINTA ASSOCIATES INC		29 MAPLEWOOD DRIVE BINGHAMTON NY 13901	02/21/2017	02/21/2022
DOL	DOL		LAVERN GLAVE		161 ROBYN RD MONROE NY 10950	09/15/2014	09/15/2019
DOL	DOL		LAVERN GLAVE		161 ROBYN RD MONROE NY 10950	01/30/2018	01/30/2023
DOL	DOL		LAWRENCE J RUGGLES		P O BOX 371 ROUND LAKE NY 12151	05/12/2014	05/12/2019
DOL	DOL	****1364	LEAD CONSTRUCTION SERVICES INC		3 ALAN B SHEPARD PLACE YONKERS NY 10705	03/19/2015	03/19/2020
DOL	DOL	****4388	LEN.J CONSTRUCTION, LLC		PO BOX 10007 ALBANY NY 12201	06/24/2016	09/19/2022
DOL	DOL	****4388	LEN.J CONSTRUCTION, LLC		PO BOX 10007 ALBANY NY 12201	06/24/2016	09/19/2022
DOL	DOL	****4388	LEN.J CONSTRUCTION, LLC		PO BOX 10007 ALBANY NY 12201	09/19/2017	09/19/2022
DOL	DOL	****4388	LEN.J CONSTRUCTION, LLC		PO BOX 10007 ALBANY NY 12201	09/19/2017	09/19/2022
DOL	DOL	****4388	LEN.J CONSTRUCTION, LLC		PO BOX 10007 ALBANY NY 12201	01/17/2017	09/19/2022
DOL	DOL	****4388	LEN.J CONSTRUCTION, LLC		PO BOX 10007 ALBANY NY 12201	09/19/2017	09/19/2022
DOL	DOL	****4388	LEN.J CONSTRUCTION, LLC		PO BOX 10007 ALBANY NY 12201	09/19/2017	09/19/2022
DOL	DOL	****4388	LEN.J CONSTRUCTION, LLC		PO BOX 10007 ALBANY NY 12201	08/14/2017	09/19/2022
DOL	AG		LEONID FRIDMAN		APT 5 200 BRIGHTON, 15TH STBROOKLYN NY 11235	01/23/2014	01/23/2019
DOL	DOL		LEROY NELSON JR		PO BOX 10007 ALBANY NY 12201	09/19/2017	09/19/2022
DOL	DOL		LEROY NELSON JR		PO BOX 10007 ALBANY NY 12201	09/19/2017	09/19/2022
DOL	DOL		LEROY NELSON JR		PO BOX 10007 ALBANY NY 12201	09/19/2017	09/19/2022
DOL	DOL		LEROY NELSON JR		PO BOX 10007 ALBANY NY 12201	09/19/2017	09/19/2022
DOL	DOL		LEROY NELSON JR		PO BOX 10007 ALBANY NY 12201	08/14/2017	08/14/2022
DOL	DOL		LEROY NELSON JR		PO BOX 10007 ALBANY NY 12201	01/17/2017	09/19/2022
DOL	DOL		LINDSEY R CRILL		143 FILLMORE AVENUE BUFFALO NY 14210	01/08/2015	01/08/2020
DOL	DA	****4460	LONG ISLAND GLASS & STOREFRONTS, LLC		4 MANHASSET TRL RIDGE NY 11961	09/06/2018	09/06/2023
DOL	AG	****4216	LOTUS-C CORP.		81-06 34TH AVENUE APT. 6EJACKSON HEIGHTS NY 11372	02/07/2018	02/07/2023
DOL	AG		LUIS MARTINEZ	LALO DRYWALL	211 MAIN ST. NEW PLATZ NY 12561	05/20/2016	05/20/2021
DOL	DOL		M ANVER BEIG		142 EAST MARKET STREET LONG BEACH NY 11561	03/07/2017	03/07/2022
DOL	AG	****6957	M B DIN CONSTRUCTION INC		8831 20TH AVENUE/SUITE 6E BROOKLYN NY 11214	11/17/2015	11/17/2020
DOL	NYC	****6317	M S QUALITY CONSTRUCTION LLC		27 MAPLEWOOD AVENUE COLONIA NJ 07067	02/04/2015	02/04/2020
DOL	DOL		M. ANVER BEIG		142 EAST MARKET STREET LONG BEACH NY 11561	03/07/2017	03/07/2022

NYS DOL Bureau of Public Work Debarment List 12/11/2018

Article 9

DOL	NYC		MACIEJ SONTOWSKI		27 MAPLEWOOD AVENUE COLONIA NJ 07067	02/04/2015	02/04/2020
DOL	NYC	****9590	MACK GLASSNAUTH IRON WORKS INC		137 LIBERTY AVENUE BROOKLYN NY 11212	12/21/2015	12/21/2020
DOL	NYC	****3141	MACKEY REED ELECTRIC INC		1ST FLOOR STORE FRONT 88-10 LITTLE NECK PARKWAYFLORAL PARK NY 11001	06/24/2014	06/24/2019
DOL	DOL	****1784	MADISON AVE CONSTRUCTION CORP		39 PENNY STREET WEST ISLIP NY 11795	11/02/2016	11/02/2021
DOL	DOL		MALARKEY'S BAR & GRILL LLC		64 VICTORIA DRIVE BINGHAMTON NY 13904	02/04/2016	02/04/2021
DOL	DOL	****0705	MALARKEY'S PUB & GRUB LLC		64 VICTORIA DRIVE BINGHAMTON NY 13904	02/04/2016	02/04/2021
DOL	DA		MANUEL P TOBIO		150 KINGS STREET BROOKLYN NY 14444	08/19/1998	08/19/2998
DOL	DA		MANUEL TOBIO		150 KINGS STREET BROOKLYN NY 11231	08/19/1998	08/19/2998
DOL	DOL		MARIACHI'S PIZZERIA		C/O DOUGLAS L MALARKEY 64 VICTORIA DRIVEBINGHAMTON NY 13904	02/04/2016	02/04/2021
DOL	DOL		MARK MIONIS		6409 LAND O LAKES BLVD LAND O LAKES FL 34638	11/10/2015	11/10/2020
DOL	DOL		MARVIN A STURDEVANT		29 MAPLEWOOD DRIVE BINGHAMTON NY 13901	02/21/2017	02/21/2022
DOL	DOL		MASONRY CONSTRUCTION, INC.		442 ARMONK RD MOUNT KISCO NY 10549	06/12/2018	06/12/2023
DOL	DOL	****3333	MASONRY INDUSTRIES, INC.		442 ARMONK RD MOUNT KISCO NY 10549	06/12/2018	06/12/2023
DOL	DOL		MATTHEW IDEMA GENERAL CONTRACTORS INC		91 COLLEGE AVENUE POUGHKEEPSIE NY 12603	12/04/2015	12/04/2020
DOL	DOL		MAURICE GAWENO		442 ARMONK RD MOUNT KISCO NY 10549	06/12/2018	06/12/2023
DOL	DOL	****6416	MCCALL MASONRY		P O BOX 304 SAYRE PA 18840	08/09/2016	08/09/2021
DOL	DOL	****4259	MERCANDO CONTRACTING CO INC		134 MURRAY AVENUE YONKERS NY 10704	12/11/2009	02/03/2019
DOL	DOL	****0327	MERCANDO INDUSTRIES LLC		134 MURRAY AVENUE YONKERS NY 10704	12/11/2009	02/03/2019
DOL	NYC	****5330	METRO DUCT SYSTEMS INC		1219 ASTORIA BOULEVARD LONG ISLAND CITY NY 11102	04/16/2014	11/19/2020
DOL	DOL	****3368	MICEK CONSTRUCTION CO INC		20 CROSS STREET FALCONER NY 14733	12/02/2014	12/02/2019
DOL	DOL		MICHAEL A PASCARELLA		SUITE 100 2105 WEST GENESEE STREET SYRACUSE NY 13219	01/06/2016	01/06/2021
DOL	NYC		MICHAEL HIRSCH		C/O MZM CORP 163 S MAIN STREETNEW CITY NY 10956	01/28/2016	01/28/2021
DOL	DOL		MICHAEL LENIHAN		1079 YONKERS AVE UNIT 4YONKERS NY 10704	08/07/2018	08/07/2023
DOL	AG		MICHAEL RIGLIETTI		31 BAY ST BROOKLYN NY 11231	03/28/2018	03/28/2023
DOL	DOL		MICHAEL WILSON	WILSON BROTHER DRYWALL CONTRACTOR S	36 ABERSOLD STREET ROCHESTER NY 14621	08/31/2015	08/31/2020
DOL	NYC		MILANCE HADZIC		22 CALIFORNIA AVE - STE 1 PATERSON NJ 07503	03/11/2015	03/11/2020
DOL	AG		MOHAMMED N CHATHA		8831 20TH AVENUE/SUITE 6E BROOKLYN NY 11214	11/17/2015	11/17/2020
DOL	DOL	****2737	MOUNTAIN'S AIR INC		2471 OCEAN AVENUE- STE 7A BROOKLYN NY 11229	09/24/2012	09/18/2020
DOL	AG		MSR ELECTRICAL CONSTRUCTION CORP.		31 BAY ST BROOKLYN NY 11231	03/28/2018	03/28/2023
DOL	DOL		MUHAMMAD BEIG		142 EAST MARKET STREET LONG BEACH NY 11561	03/07/2017	03/07/2022
DOL	DOL		MUHAMMAD BEIG		142 EAST MARKET STREET LONG BEACH NY 11561	03/07/2017	03/07/2022
DOL	DOL		MUHAMMAD PERVAIZ		C/O CHAMPION CONSTRUCTION 2131 SCHENECTADY AVENUEBROOKLYN NY 11234	11/18/2015	11/18/2020
DOL	NYC	****3613	MZM CORP		163 S MAIN STREET NEW CITY NY 10956	01/28/2016	01/28/2021
DOL	NYC	****1284	NEW AMERICAN RESTORATION INC		22 CALIFORNIA AVE - STE 1 PATERSON NJ 07503	03/11/2015	03/11/2020

NYS DOL Bureau of Public Work Debarment List 12/11/2018

Article 9

DOL	DA	****6988	NEW YORK INSULATION INC		58-48 59TH STREET MASPETH NY 11378	05/16/2012	05/08/2020
DOL	NYC	****4839	NEW YORK RIGGING CORP		58-83 54TH STREET MASPETH NY 11378	02/26/2016	02/26/2021
DOL	NYC		NICHOLAS PROVENZANO		147 BROOME AVENUE ATLANTIC BEACH NY 11509	03/03/2014	03/03/2019
DOL	NYC		NICHOLAS PROVENZANO		147 BROOME AVENUE ATLANTIC BEACH NY 11509	03/03/2014	03/03/2019
DOL	NYC	****1968	NORTH AMERICAN IRON WORKS INC		1560 DECATUR STREET RIDGWOOD NY 11385	05/15/2015	05/15/2020
DOL	DOL	****6966	NORTH COUNTRY DRYWALL AND PAINT		23167 COUNTY ROUTE 59 DEXTER NY 13634	10/24/2016	10/24/2021
DOL	DOL	****0065	NORTHEAST LANDSCAPE AND MASONRY ASSOC		3 WEST MAIN ST/SUITE 208 ELMSFORD NY 10523	01/23/2017	01/23/2022
DOL	DOL	****1845	OC ERECTERS, LLC A/K/A OC ERECTERS OF NY INC.		1207 SW 48TH TERRACE DEERFIELD BEACH FL 33442	01/16/2018	01/16/2023
DOL	NYC	****8337	OPTIMUM CONSTRUCTION INC		23-73 48TH STREET LONG ISLAND CITY NY 11103	04/24/2014	04/24/2019
DOL	NYC		ORSON ARROYO		C/O METRO DUCT SYSTEMS 12-19 ASTORIA BOULEVARDLONG ISLAND CITY NY 11102	04/16/2014	11/19/2020
DOL	DOL	****4546	PAF PAINTING CORP		161 TIBBETTS ROAD YONKERS NY 10705	03/12/2014	03/12/2019
DOL	DOL	****5242	PAF PAINTING SERVICES INC	GARDEN STATE PAINTING	157 TIBBETTS ROAD YONKERS NY 10103	03/12/2014	03/12/2019
DOL	DOL		PAF PAINTING SERVICES OF WESTCHESTER INC		C/O SPIEGEL & UTRERA 1 MAIDEN LANE - 5TH FLNEW YORK NY 10038	03/12/2014	03/12/2019
DOL	DOL	****8802	PAT'S HEATING AND AIR CONDITIONING LTD		P O BOX 371 ROUND LAKE NY 12151	05/12/2014	05/12/2019
DOL	DOL		PATRICIA M RUGGLES		P O BOX 371 ROUND LAKE NY 12151	05/12/2014	05/12/2019
DOL	NYC	****9422	PELIUM CONSTRUCTION, INC.		22-33 35TH ST. ASTORIA NY 11105	12/30/2016	12/30/2021
DOL	DOL		PETER M PERGOLA		3 WEST MAIN ST/SUITE 208 ELMSFORD NY 10523	01/23/2017	01/23/2022
DOL	DOL		PIERRE LAPORT		224 COUNTY HIGHWAY 138 BROADALBIN NY 12025	03/07/2017	03/07/2022
DOL	DOL	****1543	PJ LAPORT FLOORING INC		224 COUNTY HIGHWAY 138 BROADALBIN NY 12025	03/07/2017	03/07/2022
DOL	DOL	****2989	PROFESSIONAL ESTIMATING & BUSINESS CORP		157 TIBBETS ROAD YONKERS NY 10705	03/12/2014	03/12/2019
DOL	DOL	****6895	PROLINE CONCRETE OF WNY INC		3090 SHIRLEY ROAD NORTH COLLINS NY 14111	04/19/2011	07/08/2020
DOL	DA	****6817	QUADRANT METAL BUILDINGS LLC		2740 SW MARTIN DOWNS BLVD PALM CITY FL 34990	08/25/2016	08/25/2021
DOL	DOL	****0015	RAMADA CONSTRUCTION CORP		80 SAVO LOOP STATEN ISLAND NY 10309	01/07/2014	01/07/2019
DOL	NYC		RAMESHWAR ASU		137 LIBERTY AVENUE BROOKLYN NY 11212	12/21/2015	12/21/2020
DOL	DOL		RANA A KAHN		1973 81ST ST - SUITE A-5 BROOKLYN NY 11214	01/08/2015	01/08/2020
DOL	NYC		RANTIK PARIKH		13 LORIANN ROAD WARREN NJ 07059	07/15/2015	07/15/2020
DOL	DOL	****2633	RAW POWER ELECTRIC CORP		3 PARK CIRCLE MIDDLETOWN NY 10940	09/16/2013	09/15/2019
DOL	DOL	****2633	RAW POWER ELECTRIC CORP		3 PARK CIRCLE MIDDLETOWN NY 10940	01/30/2018	01/30/2023
DOL	NYC		RAYMOND PEARSON		P O BOX 957 PORT JEFFERSON STA NY 11776	03/12/2014	03/12/2019
DOL	AG	****7015	RCM PAINTING INC.		69-06 GRAND AVENUE 2ND FLOORMASPETH NY 11378	02/07/2018	02/07/2023
DOL	DOL		REGINALD WARREN		161 ROBYN RD MONROE NY 10950	09/15/2014	09/15/2019
DOL	DOL		REGINALD WARREN		161 ROBYN RD MONROE NY 10950	01/30/2018	01/30/2023
DOL	NYC	****3461	RELIANCE GENERAL CONSTRUCTION INC		644 OCEAN PARKWAY BROOKLYN NY 11230	09/02/2015	09/02/2020
DOL	DOL		REVOLUTIONARY FLOORS LLC		P O BOX 268 STILLWATER NY 12170	09/16/2013	03/21/2019
DOL	DOL		RHINO CONCRETE LLC		101 SULLYS TRAIL/SUITE 20 PITTSFORD NY 14534	11/18/2013	01/07/2019

NYS DOL Bureau of Public Work Debarment List 12/11/2018

Article 9

DOL	DA		RIANN MULLER		2740 SW MARTIN DOWNS BLVD PALM CITY FL 34990	08/25/2016	08/25/2021
DOL	DOL		RICHARD MACONE		8617 THIRD AVE BROOKLYN NY 11209	09/17/2018	09/17/2023
DOL	DOL	****9148	RICHARD TIMIAN	RICH T CONSTRUCTI ON	108 LAMONT AVE SYRACUSE NY 13209	10/16/2018	10/16/2023
DOL	DOL		RICHARD TIMIAN JR.		108 LAMONT AVE SYRACUSE NY 13209	10/16/2018	10/16/2023
DOL	DOL		RICHARD WILSON		C/O DUFOUR GROUP INC 353 WEST 56TH STREET #7MNEW YORK NY 10019	06/10/2014	06/10/2019
DOL	DOL	****8618	RIEKS CONTRACTING LLC		4804 GAHWILER ROAD AUBURN NY 13021	05/01/2015	05/01/2020
DOL	DOL		ROBBYE BISSE SAR		89-51 SPRINGFIELD BLVD QUEENS VILLAGE NY 11427	01/11/2003	01/11/3003
DOL	DOL		ROBERT BRUNO		3 GAYLORD ST AUBURN NY 13021	11/15/2016	11/15/2021
DOL	DOL	****1855	ROBERT D BISHOP JR	ROBERT D BISHOP JR	P O BOX 112 MORRISONVILLE NY 12962	07/15/2014	07/15/2019
DOL	DOL		ROBERT D BISHOP JR		P O BOX 112 MORRISONVILLE NY 12962	07/15/2014	07/15/2019
DOL	NYC		ROBERT GUIDO		3256 BRUNER AVENUE BRONX NY 10469	07/29/2014	07/29/2019
DOL	DOL		ROBERT TORDELLA		125 CHAUTAUQUA AVENUE LAKEWOOD NY 14750	06/24/2015	06/24/2020
DOL	DOL	****3859	ROCHESTER ACOUSTICAL CORP		P O BOX 799 HILTON NY 14468	02/19/2016	02/19/2021
DOL	DOL		RODERICK PUGH		404 OAK ST SUITE 101SYRACUSE NY 13203	07/23/2018	07/23/2023
DOL	DOL	****4880	RODERICK PUGH CONSTRUCTION INC.		404 OAK ST SUITE 101SYRACUSE NY 13203	07/23/2018	07/23/2023
DOL	NYC		RODNEY SCOTT		201 HEMPSTEAD AVENUE WEST HEMPSTEAD NY 11552	10/30/2015	10/30/2020
DOL	DOL		ROMEO WARREN		161 ROBYN RD MONROE NY 10950	09/16/2013	09/15/2019
DOL	DOL		ROMEO WARREN		161 ROBYN RD MONROE NY 10950	01/30/2018	01/30/2023
DOL	DOL		ROSEANNE CANTISANI			06/12/2018	06/12/2023
DOL	DOL		RYAN ALBIE		21 S HOWELLS POINT ROAD BELLPORT NY 11713	02/21/2017	02/21/2022
DOL	DOL	****3347	RYAN ALBIE CONTRACTING INC		21 S HOWELLS POINT ROAD BELLPORT NY 11713	02/21/2017	02/21/2022
DOL	NYC		SABIR MUHAMMED		SUITE B-8 782 PELHAM PARKWAY SOUTHBRONX NY 10462	04/21/2016	04/21/2021
DOL	NYC		SAEED HASAN		4558 BROADWAY #6 NEW YORK NY 10040	08/04/2014	08/04/2019
DOL	NYC	****2117	SCOTT ELECTRICAL LLC		201 HEMPSTEAD AVENUE WEST HEMPSTEAD NY 11552	10/30/2015	10/30/2020
DOL	DOL	****9751	SCW CONSTRUCTION		544 OLD ROUTE 23 ACRE NY 12405	02/14/2017	02/14/2022
DOL	DOL		SEAN BURBAGE	C/O SEAN BURBAGE CORP	445 ROOSA GAP ROAD BLOOMINGBURG NY 12721	04/14/2014	04/14/2019
DOL	DOL	****6586	SEAN BURBAGE CORP		445 ROOSA GAP ROAD BLOOMINGBURG NY 12721	04/14/2014	04/14/2019
DOL	AG		SERGIO RAYMUNDO		109 DUBOIS RD. NEW PALTZ NY 12561	05/20/2016	05/20/2021
DOL	DOL	****1961	SHANE BURDICK	CENTRAL TRAFFIC CONTROL, LLC.	2238 BAKER ROAD GILLET PA 16923	03/12/2018	03/12/2023
DOL	DOL		SHANE BURDICK		2238 BAKER ROAD GILLET PA 16923	03/12/2018	03/12/2023
DOL	DOL		SHANE NOLAN		9365 WASHINGTON ST LOCKPORT IL 60441	07/23/2018	07/23/2023
DOL	DOL	****0816	SOLAR ARRAY SOLUTIONS, LLC		9365 WASHINGTON ST LOCKPORT IL 60441	07/23/2018	07/23/2023
DOL	DOL	****4025	SOLUTION MATTERS INC		198 NORWOOD ROAD PORT JEFFERSON NY 11776	11/19/2015	11/19/2020
DOL	NYC	****4934	SPHINX CONTRACTING CORP		240 HOME STREET TEANECK NJ 07666	08/04/2014	08/04/2019

NYS DOL Bureau of Public Work Debarment List 12/11/2018

Article 9

DOL	DOL	****3496	STAR INTERNATIONAL INC		89-51 SPRINGFIELD BLVD QUEENS VILLAGE NY 11427	08/11/2003	08/11/3003
DOL	DOL		STEPHEN BIANCHI		462 LAKEVIEW AVENUE VALHALLA NY 10595	12/16/2013	12/16/2018
DOL	DOL	****9751	STEPHEN C WAGAR		544 OLD ROUTE 23 ACRE NY 12405	02/14/2017	02/14/2022
DOL	DOL		STEVE TATE		415 FLAGER AVE #302STUART FL 34994	10/31/2018	10/31/2023
DOL	DOL		STEVEN P SUCATO		15-68 208TH STREET BAYSIDE NY 11360	06/23/2016	06/23/2021
DOL	DOL		STEVEN SAGGESE		3005 WYNSUM AVENUE MERRICK NY 11566	08/18/2014	08/18/2019
DOL	DOL		STEVEN TESTA		50 SALEM STREET - BLDG B LYNNFIELD MA 01940	01/23/2017	01/23/2022
DOL	NYC	****9432	SUBLINK LTD		346 THIRD AVENUE PELHAM NY 10803	11/19/2015	11/19/2020
DOL	DOL	****7441	T & T CONCRETE INC		2560 HAMBURG TURNPIKE P O BOX 367LACKAWANNA NY 14218	07/08/2015	07/08/2020
DOL	DOL	****7417	TADCO CONSTRUCTION		101-61 99TH STREET OZONE PARK NY 11416	02/15/2017	02/15/2022
DOL	DOL		TADCO CONSTRUCTION		101-61 99TH STREET OZONE PARK NY 11416	02/15/2017	02/15/2022
DOL	DOL	****7417	TADCO CONSTRUCTION CORP		101-61 99TH STREET OZONE PARK NY 11416	02/15/2017	02/15/2022
DOL	DOL		TALAILA OCAMPA		1207 SW 48TH TERRACE DEERFIELD BEACH FL 33442	01/16/2018	01/16/2023
DOL	DOL		TAMMY LACITIGNOLA		C/O CATSKILL FENCE INSTAL 5445 ROUTE 32CATSKILL NY 12414	08/22/2014	08/22/2019
DOL	DOL	****9852	TAP STEEL INC		ROUTE 26 3101 P O BOX 457CONSTABLEVILLE NY 13325	01/28/2016	01/28/2021
DOL	DOL		TECH-MECHANICAL FAB DC INC		5 PARKER AVENUE POUGHKEEPSIE NY 12601	03/25/2014	03/25/2019
DOL	DOL	****5570	TESTA CORP		50 SALEM STREET - BLDG B LYNNFIELD MA 01940	01/23/2017	01/23/2022
DOL	DOL	****0887	THE BRINSON PAINTING CORPORATION		72 TAUNTON PLACE BUFFALO NY 14216	04/14/2015	04/14/2020
DOL	DOL	****8174	THE DALRYMPLE CORPORATION		UNIT 278 541 10TH STREET NWLANTA GA 30318	12/01/2015	12/01/2020
DOL	DOL	****8174	THE DALRYMPLE GROUP LLC		289 JONESBORO RD/ STE 216 MCDONOUGH GA 30253	12/01/2015	12/01/2020
DOL	DOL	****9243	THE WELCOME MAT PROPERTY MANAGEMENT LLC		P O BOX 268 STILLWATER NY 12170	09/16/2013	03/21/2019
DOL	DOL		TIMOTHY A PALUCK		C/O TAP STEEL INC RTE 26 3101/ P O BOX 457CONSTABLEVILLE NY 13325	01/28/2016	01/28/2021
DOL	DOL	****0600	TOMSON ALLOYS RECYCLING INC		143 FILLMORE AVENUE BUFFALO NY 14210	01/08/2015	01/08/2020
DOL	DOL	****3453	TORCHIA'S HOME IMPROVEMENT		10153 ROBERTS RD SAUQUOIT NY 13456	08/09/2016	08/09/2021
DOL	DOL	****6914	TRI-COUNTY RESTORATIONS & CONSTRUCTION INC		13 SUMMERSET DRIVE WALLKILL NY 12589	08/22/2014	08/22/2019
DOL	DOL		TRI-COUNTY RESTORATIONS INC		392 ROCK CUT ROAD WALDEN NY 12586	08/22/2014	08/22/2019
DOL	DOL	****8311	TRIPLE B FABRICATING, INC.		61 WILLETT ST. PASSAIC NJ 07503	10/26/2016	10/26/2021
DOL	DOL	****9407	TURBO GROUP INC		15-68 208TH STREET BAYSIDE NY 11360	06/23/2016	06/23/2021
DOL	AG	****6490	UNIVERSAL STEEL FABRICATORS INC		90 JUNIUS STREET BROOKLYN NY 11212	01/23/2014	01/23/2019
DOL	NYC	****7174	V&R CONTRACTING		P O BOX 957 PORT JEFFERSON STA NY 11776	03/12/2014	03/12/2019
DOL	DOL	****6392	V.M.K CORP.		8617 THIRD AVE BROOKLYN NY 11209	09/17/2018	09/17/2023
DOL	NYC		VALERIE VISCONTI		346 THIRD AVENUE PELHAM NY 10803	11/19/2015	11/19/2020
DOL	NYC		VEAP SELA	C/O COLONIAL ROOFING COMPANY INC	247 48TH STREET BROOKLYN NY 11220	02/05/2014	02/05/2019
DOL	NYC		VICK CONSTRUCTION		21 DAREWOOD LANE VALLEY STREAM NY 11581	12/31/2013	12/31/2018

NYS DOL Bureau of Public Work Debarment List 12/11/2018

Article 9

DOL	NYC		VICKRAM MANGRU	VICK CONSTRUCTI ON	21 DAREWOOD LANE VALLEY STREAM NY 11581	12/31/2013	12/31/2018
DOL	DOL		VICTOR ROTENBERG		C/O GMDV TRANS INC 67048 182ND STREET FRESH MEADOWS NY 11365	06/24/2016	06/24/2021
DOL	NYC		VIKTAR PATONICH		2630 CROSEY AVE BROOKLYN NY 11214	10/30/2018	10/30/2023
DOL	NYC		VINCENT PIZZITOLA		P O BOX 957 PORT JEFFERSON STA NY 11776	03/12/2014	03/12/2019
DOL	NYC		VITO GARGANO		1535 RICHMOND AVE STATEN ISLAND NY 10314	12/13/2017	12/13/2022
DOL	DOL		WAYNE LIVINGSTON JR	NORTH COUNTRY DRYWALL AND PAINT	23167 COUNTY ROUTE 59 DEXTER NY 13634	10/24/2016	10/24/2021
DOL	DOL		WHITE PLAINS CARPENTRY CORP		442 ARMONK RD	06/12/2018	06/12/2023
DOL	DOL		WILLIAM CONKLIN		5 PARKER AVENUE POUGHKEEPSIE NY 12601	03/25/2014	03/25/2019
DOL	DOL		WILLIAM DEAK		C/O MADISON AVE CONSTR CO 39 PENNY STREET WEST ISLIP NY 11795	11/02/2016	11/02/2021
DOL	DOL		WILLIAM MAZZELLA		134 MURRAY AVENUE YONKERS NY 10704	02/03/2014	02/03/2019
DOL	DOL		WILLIE BRINSON		72 TAUNTON PLACE BUFFALO NY 14216	04/14/2015	04/14/2020
DOL	DOL	****6195	WILSON BROTHER DRYWALL CONTRACTORS		36 ABERSOLD STREET ROCHESTER NY 14621	08/31/2015	08/31/2020
DOL	DOL	****4043	WINDSHIELD INSTALLATION NETWORK, INC.		200 LATTA BROOK PARK HORSEHEADS NY 14845	03/08/2018	03/08/2023
DOL	DOL	****4730	XGD SYSTEMS, LLC	TDI GOLF	415 GLAGE AVE #302 STUART FL 34994	10/31/2018	10/31/2023
DOL	DOL	****7345	YES SERVICE AND REPAIRS CORPORATION		145 LODGE AVE HUNTINGTON STATION NY 11476	08/09/2016	08/09/2021
DOL	DOL		YURIY IVANIN		C/O MOUNTAIN'S AIR INC 2471 OCEAN AVENUE-STE 7A BROOKLYN NY 11229	09/24/2012	09/18/2020
DOL	NYC		ZAKIR NASEEM		30 MEADOW ST BROOKLYN NY 11206	10/10/2017	10/10/2022
DOL	NYC	****8277	ZHN CONTRACTING CORP		30 MEADOW ST BROOKLYN NY 11206	10/10/2017	10/10/2022

NYS DOL Bureau of Public Work Debarment List 12/11/2018

Article 9

AGENCY	Fiscal Officer	FEIN	EMPLOYER NAME	EMPLOYER DBA NAME	ADDRESS	DEBARMENT START DATE	DEBARMENT END DATE
DOL	DOL	*****5530	CFM SERVICE CORPORATION INC		P O BOX 548 225 MONTAUK HWY/SUITE 219MORICHES NY 11955	11/28/2012	04/15/2021
DOL	DOL		DENNIS DAN OGBEIDE		P.O BOX 50028 BRONX NY 10458	04/24/2018	04/24/2023
DOL	DOL	*****5067	DENOG PROTECTIVE SECURITY SERVICES INC		P. O BOX 50028 BRONX NY 10458	04/24/2018	04/24/2023
DOL	DOL		JOSEPH KLEINPETER	CFM SERVICE CORPORATIO N INC	P O BOX 548 225 MONTAUK HWY/SUITE 219MORICHES NY 11955	11/28/2012	04/15/2021
DOL	NYC		ROBERT SARDINA		C/O TRAFFIC MOVING SYSTEM 66 ALEXANDER STREET YONKERS NY 10701	03/31/2015	03/31/2020
DOL	NYC	*****2049	TRAFFIC MOVING SYSTEMS INC		66 ALEXANDER STREET YONKERS NY 10701	03/31/2015	03/31/2020

ESSEX COUNTY PURCHASING
7551 COURT STREET – PO BOX 217
ELIZABETHTOWN, NY 12932

NON-BIDDER RESPONSE

Bid/RFP Name: _____

The Essex County Purchasing Department is interested in the reasons why bidders fail to submit bids. Please indicate your reason(s) by checking all appropriate item(s) below and returning this form to the above address.

- Could not meet specifications or Scope of Services.
- Items or materials requested not manufactured by us or not available to our company.
- Insurance Requirements are too restricting.
- Bond requirements are too restricting.
- Specifications or Scope of Services not clearly understood or applicable (too vague, too rigid, etc.)
- Project not suited to firm,
- Quantities too small.
- Insufficient time allowed for preparation of bid.
- Other reasons; please state and define:

Vendor Name: _____

Contact Person: _____

Vendor Address: _____

Vendor Telephone: _____

Request for Taxpayer Identification Number and Certification

**Give Form to the
 requester. Do not
 send to the IRS.**

Print or type See Specific Instructions on page 2.	1 Name (as shown on your income tax return). Name is required on this line; do not leave this line blank.	
	2 Business name/disregarded entity name, if different from above	
	3 Check appropriate box for federal tax classification; check only one of the following seven boxes: <input type="checkbox"/> Individual/sole proprietor or single-member LLC <input type="checkbox"/> C Corporation <input type="checkbox"/> S Corporation <input type="checkbox"/> Partnership <input type="checkbox"/> Trust/estate <input type="checkbox"/> Limited liability company. Enter the tax classification (C=C corporation, S=S corporation, P=partnership) ▶ _____ Note. For a single-member LLC that is disregarded, do not check LLC; check the appropriate box in the line above for the tax classification of the single-member owner. <input type="checkbox"/> Other (see instructions) ▶ _____	4 Exemptions (codes apply only to certain entities, not individuals; see instructions on page 3): Exempt payee code (if any) _____ Exemption from FATCA reporting code (if any) _____ <i>(Applies to accounts maintained outside the U.S.)</i>
	5 Address (number, street, and apt. or suite no.)	Requester's name and address (optional)
	6 City, state, and ZIP code	
	7 List account number(s) here (optional)	

Part I Taxpayer Identification Number (TIN)

Enter your TIN in the appropriate box. The TIN provided must match the name given on line 1 to avoid backup withholding. For individuals, this is generally your social security number (SSN). However, for a resident alien, sole proprietor, or disregarded entity, see the Part I instructions on page 3. For other entities, it is your employer identification number (EIN). If you do not have a number, see *How to get a TIN* on page 3.

Note. If the account is in more than one name, see the instructions for line 1 and the chart on page 4 for guidelines on whose number to enter.

Social security number										
					-					
					-					
OR										
Employer identification number										
					-					

Part II Certification

Under penalties of perjury, I certify that:

1. The number shown on this form is my correct taxpayer identification number (or I am waiting for a number to be issued to me); and
2. I am not subject to backup withholding because: (a) I am exempt from backup withholding, or (b) I have not been notified by the Internal Revenue Service (IRS) that I am subject to backup withholding as a result of a failure to report all interest or dividends, or (c) the IRS has notified me that I am no longer subject to backup withholding; and
3. I am a U.S. citizen or other U.S. person (defined below); and
4. The FATCA code(s) entered on this form (if any) indicating that I am exempt from FATCA reporting is correct.

Certification instructions. You must cross out item 2 above if you have been notified by the IRS that you are currently subject to backup withholding because you have failed to report all interest and dividends on your tax return. For real estate transactions, item 2 does not apply. For mortgage interest paid, acquisition or abandonment of secured property, cancellation of debt, contributions to an individual retirement arrangement (IRA), and generally, payments other than interest and dividends, you are not required to sign the certification, but you must provide your correct TIN. See the instructions on page 3.

Sign Here	Signature of U.S. person ▶	Date ▶
------------------	----------------------------	--------

General Instructions

Section references are to the Internal Revenue Code unless otherwise noted.
Future developments. Information about developments affecting Form W-9 (such as legislation enacted after we release it) is at www.irs.gov/fw9.

Purpose of Form

An individual or entity (Form W-9 requester) who is required to file an information return with the IRS must obtain your correct taxpayer identification number (TIN) which may be your social security number (SSN), individual taxpayer identification number (ITIN), adoption taxpayer identification number (ATIN), or employer identification number (EIN), to report on an information return the amount paid to you, or other amount reportable on an information return. Examples of information returns include, but are not limited to, the following:

- Form 1099-INT (interest earned or paid)
- Form 1099-DIV (dividends, including those from stocks or mutual funds)
- Form 1099-MISC (various types of income, prizes, awards, or gross proceeds)
- Form 1099-B (stock or mutual fund sales and certain other transactions by brokers)
- Form 1099-S (proceeds from real estate transactions)
- Form 1099-K (merchant card and third party network transactions)

- Form 1098 (home mortgage interest), 1098-E (student loan interest), 1098-T (tuition)
- Form 1099-C (canceled debt)
- Form 1099-A (acquisition or abandonment of secured property)

Use Form W-9 only if you are a U.S. person (including a resident alien), to provide your correct TIN.

If you do not return Form W-9 to the requester with a TIN, you might be subject to backup withholding. See What is backup withholding? on page 2.

By signing the filled-out form, you:

1. Certify that the TIN you are giving is correct (or you are waiting for a number to be issued),
2. Certify that you are not subject to backup withholding, or
3. Claim exemption from backup withholding if you are a U.S. exempt payee. If applicable, you are also certifying that as a U.S. person, your allocable share of any partnership income from a U.S. trade or business is not subject to the withholding tax on foreign partners' share of effectively connected income, and
4. Certify that FATCA code(s) entered on this form (if any) indicating that you are exempt from the FATCA reporting, is correct. See *What is FATCA reporting?* on page 2 for further information.

Note. If you are a U.S. person and a requester gives you a form other than Form W-9 to request your TIN, you must use the requester's form if it is substantially similar to this Form W-9.

Definition of a U.S. person. For federal tax purposes, you are considered a U.S. person if you are:

- An individual who is a U.S. citizen or U.S. resident alien;
- A partnership, corporation, company, or association created or organized in the United States or under the laws of the United States;
- An estate (other than a foreign estate); or
- A domestic trust (as defined in Regulations section 301.7701-7).

Special rules for partnerships. Partnerships that conduct a trade or business in the United States are generally required to pay a withholding tax under section 1446 on any foreign partners' share of effectively connected taxable income from such business. Further, in certain cases where a Form W-9 has not been received, the rules under section 1446 require a partnership to presume that a partner is a foreign person, and pay the section 1446 withholding tax. Therefore, if you are a U.S. person that is a partner in a partnership conducting a trade or business in the United States, provide Form W-9 to the partnership to establish your U.S. status and avoid section 1446 withholding on your share of partnership income.

In the cases below, the following person must give Form W-9 to the partnership for purposes of establishing its U.S. status and avoiding withholding on its allocable share of net income from the partnership conducting a trade or business in the United States:

- In the case of a disregarded entity with a U.S. owner, the U.S. owner of the disregarded entity and not the entity;
- In the case of a grantor trust with a U.S. grantor or other U.S. owner, generally, the U.S. grantor or other U.S. owner of the grantor trust and not the trust; and
- In the case of a U.S. trust (other than a grantor trust), the U.S. trust (other than a grantor trust) and not the beneficiaries of the trust.

Foreign person. If you are a foreign person or the U.S. branch of a foreign bank that has elected to be treated as a U.S. person, do not use Form W-9. Instead, use the appropriate Form W-8 or Form 8233 (see Publication 515, Withholding of Tax on Nonresident Aliens and Foreign Entities).

Nonresident alien who becomes a resident alien. Generally, only a nonresident alien individual may use the terms of a tax treaty to reduce or eliminate U.S. tax on certain types of income. However, most tax treaties contain a provision known as a "saving clause." Exceptions specified in the saving clause may permit an exemption from tax to continue for certain types of income even after the payee has otherwise become a U.S. resident alien for tax purposes.

If you are a U.S. resident alien who is relying on an exception contained in the saving clause of a tax treaty to claim an exemption from U.S. tax on certain types of income, you must attach a statement to Form W-9 that specifies the following five items:

1. The treaty country. Generally, this must be the same treaty under which you claimed exemption from tax as a nonresident alien.
2. The treaty article addressing the income.
3. The article number (or location) in the tax treaty that contains the saving clause and its exceptions.
4. The type and amount of income that qualifies for the exemption from tax.
5. Sufficient facts to justify the exemption from tax under the terms of the treaty article.

Example. Article 20 of the U.S.-China income tax treaty allows an exemption from tax for scholarship income received by a Chinese student temporarily present in the United States. Under U.S. law, this student will become a resident alien for tax purposes if his or her stay in the United States exceeds 5 calendar years. However, paragraph 2 of the first Protocol to the U.S.-China treaty (dated April 30, 1984) allows the provisions of Article 20 to continue to apply even after the Chinese student becomes a resident alien of the United States. A Chinese student who qualifies for this exception (under paragraph 2 of the first protocol) and is relying on this exception to claim an exemption from tax on his or her scholarship or fellowship income would attach to Form W-9 a statement that includes the information described above to support that exemption.

If you are a nonresident alien or a foreign entity, give the requester the appropriate completed Form W-8 or Form 8233.

Backup Withholding

What is backup withholding? Persons making certain payments to you must under certain conditions withhold and pay to the IRS 28% of such payments. This is called "backup withholding." Payments that may be subject to backup withholding include interest, tax-exempt interest, dividends, broker and barter exchange transactions, rents, royalties, nonemployee pay, payments made in settlement of payment card and third party network transactions, and certain payments from fishing boat operators. Real estate transactions are not subject to backup withholding.

You will not be subject to backup withholding on payments you receive if you give the requester your correct TIN, make the proper certifications, and report all your taxable interest and dividends on your tax return.

Payments you receive will be subject to backup withholding if:

1. You do not furnish your TIN to the requester,
2. You do not certify your TIN when required (see the Part II instructions on page 3 for details),

3. The IRS tells the requester that you furnished an incorrect TIN,

4. The IRS tells you that you are subject to backup withholding because you did not report all your interest and dividends on your tax return (for reportable interest and dividends only), or

5. You do not certify to the requester that you are not subject to backup withholding under 4 above (for reportable interest and dividend accounts opened after 1983 only).

Certain payees and payments are exempt from backup withholding. See *Exempt payee code* on page 3 and the separate Instructions for the Requester of Form W-9 for more information.

Also see *Special rules for partnerships* above.

What is FATCA reporting?

The Foreign Account Tax Compliance Act (FATCA) requires a participating foreign financial institution to report all United States account holders that are specified United States persons. Certain payees are exempt from FATCA reporting. See *Exemption from FATCA reporting code* on page 3 and the Instructions for the Requester of Form W-9 for more information.

Updating Your Information

You must provide updated information to any person to whom you claimed to be an exempt payee if you are no longer an exempt payee and anticipate receiving reportable payments in the future from this person. For example, you may need to provide updated information if you are a C corporation that elects to be an S corporation, or if you no longer are tax exempt. In addition, you must furnish a new Form W-9 if the name or TIN changes for the account; for example, if the grantor of a grantor trust dies.

Penalties

Failure to furnish TIN. If you fail to furnish your correct TIN to a requester, you are subject to a penalty of \$50 for each such failure unless your failure is due to reasonable cause and not to willful neglect.

Civil penalty for false information with respect to withholding. If you make a false statement with no reasonable basis that results in no backup withholding, you are subject to a \$500 penalty.

Criminal penalty for falsifying information. Willfully falsifying certifications or affirmations may subject you to criminal penalties including fines and/or imprisonment.

Misuse of TINs. If the requester discloses or uses TINs in violation of federal law, the requester may be subject to civil and criminal penalties.

Specific Instructions

Line 1

You must enter one of the following on this line; **do not** leave this line blank. The name should match the name on your tax return.

If this Form W-9 is for a joint account, list first, and then circle, the name of the person or entity whose number you entered in Part I of Form W-9.

a. **Individual.** Generally, enter the name shown on your tax return. If you have changed your last name without informing the Social Security Administration (SSA) of the name change, enter your first name, the last name as shown on your social security card, and your new last name.

Note. ITIN applicant: Enter your individual name as it was entered on your Form W-7 application, line 1a. This should also be the same as the name you entered on the Form 1040/1040A/1040EZ you filed with your application.

b. **Sole proprietor or single-member LLC.** Enter your individual name as shown on your 1040/1040A/1040EZ on line 1. You may enter your business, trade, or "doing business as" (DBA) name on line 2.

c. **Partnership, LLC that is not a single-member LLC, C Corporation, or S Corporation.** Enter the entity's name as shown on the entity's tax return on line 1 and any business, trade, or DBA name on line 2.

d. **Other entities.** Enter your name as shown on required U.S. federal tax documents on line 1. This name should match the name shown on the charter or other legal document creating the entity. You may enter any business, trade, or DBA name on line 2.

e. **Disregarded entity.** For U.S. federal tax purposes, an entity that is disregarded as an entity separate from its owner is treated as a "disregarded entity." See Regulations section 301.7701-2(c)(2)(iii). Enter the owner's name on line 1. The name of the entity entered on line 1 should never be a disregarded entity. The name on line 1 should be the name shown on the income tax return on which the income should be reported. For example, if a foreign LLC that is treated as a disregarded entity for U.S. federal tax purposes has a single owner that is a U.S. person, the U.S. owner's name is required to be provided on line 1. If the direct owner of the entity is also a disregarded entity, enter the first owner that is not disregarded for federal tax purposes. Enter the disregarded entity's name on line 2, "Business name/disregarded entity name." If the owner of the disregarded entity is a foreign person, the owner must complete an appropriate Form W-8 instead of a Form W-9. This is the case even if the foreign person has a U.S. TIN.

Line 2

If you have a business name, trade name, DBA name, or disregarded entity name, you may enter it on line 2.

Line 3

Check the appropriate box in line 3 for the U.S. federal tax classification of the person whose name is entered on line 1. Check only one box in line 3.

Limited Liability Company (LLC). If the name on line 1 is an LLC treated as a partnership for U.S. federal tax purposes, check the "Limited Liability Company" box and enter "P" in the space provided. If the LLC has filed Form 8832 or 2553 to be taxed as a corporation, check the "Limited Liability Company" box and in the space provided enter "C" for C corporation or "S" for S corporation. If it is a single-member LLC that is a disregarded entity, do not check the "Limited Liability Company" box; instead check the first box in line 3 "Individual/sole proprietor or single-member LLC."

Line 4, Exemptions

If you are exempt from backup withholding and/or FATCA reporting, enter in the appropriate space in line 4 any code(s) that may apply to you.

Exempt payee code.

- Generally, individuals (including sole proprietors) are not exempt from backup withholding.
- Except as provided below, corporations are exempt from backup withholding for certain payments, including interest and dividends.
- Corporations are not exempt from backup withholding for payments made in settlement of payment card or third party network transactions.
- Corporations are not exempt from backup withholding with respect to attorneys' fees or gross proceeds paid to attorneys, and corporations that provide medical or health care services are not exempt with respect to payments reportable on Form 1099-MISC.

The following codes identify payees that are exempt from backup withholding. Enter the appropriate code in the space in line 4.

- 1—An organization exempt from tax under section 501(a), any IRA, or a custodial account under section 403(b)(7) if the account satisfies the requirements of section 401(f)(2)
- 2—The United States or any of its agencies or instrumentalities
- 3—A state, the District of Columbia, a U.S. commonwealth or possession, or any of their political subdivisions or instrumentalities
- 4—A foreign government or any of its political subdivisions, agencies, or instrumentalities
- 5—A corporation
- 6—A dealer in securities or commodities required to register in the United States, the District of Columbia, or a U.S. commonwealth or possession
- 7—A futures commission merchant registered with the Commodity Futures Trading Commission
- 8—A real estate investment trust
- 9—An entity registered at all times during the tax year under the Investment Company Act of 1940
- 10—A common trust fund operated by a bank under section 584(a)
- 11—A financial institution
- 12—A middleman known in the investment community as a nominee or custodian
- 13—A trust exempt from tax under section 664 or described in section 4947

The following chart shows types of payments that may be exempt from backup withholding. The chart applies to the exempt payees listed above, 1 through 13.

IF the payment is for . . .	THEN the payment is exempt for . . .
Interest and dividend payments	All exempt payees except for 7
Broker transactions	Exempt payees 1 through 4 and 6 through 11 and all C corporations. S corporations must not enter an exempt payee code because they are exempt only for sales of noncovered securities acquired prior to 2012.
Barter exchange transactions and patronage dividends	Exempt payees 1 through 4
Payments over \$600 required to be reported and direct sales over \$5,000 ¹	Generally, exempt payees 1 through 5 ²
Payments made in settlement of payment card or third party network transactions	Exempt payees 1 through 4

¹See Form 1099-MISC, Miscellaneous Income, and its instructions.

²However, the following payments made to a corporation and reportable on Form 1099-MISC are not exempt from backup withholding: medical and health care payments, attorneys' fees, gross proceeds paid to an attorney reportable under section 6045(f), and payments for services paid by a federal executive agency.

Exemption from FATCA reporting code. The following codes identify payees that are exempt from reporting under FATCA. These codes apply to persons submitting this form for accounts maintained outside of the United States by certain foreign financial institutions. Therefore, if you are only submitting this form for an account you hold in the United States, you may leave this field blank. Consult with the person requesting this form if you are uncertain if the financial institution is subject to these requirements. A requester may indicate that a code is not required by providing you with a Form W-9 with "Not Applicable" (or any similar indication) written or printed on the line for a FATCA exemption code.

A—An organization exempt from tax under section 501(a) or any individual retirement plan as defined in section 7701(a)(37)

B—The United States or any of its agencies or instrumentalities

C—A state, the District of Columbia, a U.S. commonwealth or possession, or any of their political subdivisions or instrumentalities

D—A corporation the stock of which is regularly traded on one or more established securities markets, as described in Regulations section 1.1472-1(c)(1)(i)

E—A corporation that is a member of the same expanded affiliated group as a corporation described in Regulations section 1.1472-1(c)(1)(i)

F—A dealer in securities, commodities, or derivative financial instruments (including notional principal contracts, futures, forwards, and options) that is registered as such under the laws of the United States or any state

G—A real estate investment trust

H—A regulated investment company as defined in section 851 or an entity registered at all times during the tax year under the Investment Company Act of 1940

I—A common trust fund as defined in section 584(a)

J—A bank as defined in section 581

K—A broker

L—A trust exempt from tax under section 664 or described in section 4947(a)(1)

M—A tax exempt trust under a section 403(b) plan or section 457(g) plan

Note. You may wish to consult with the financial institution requesting this form to determine whether the FATCA code and/or exempt payee code should be completed.

Line 5

Enter your address (number, street, and apartment or suite number). This is where the requester of this Form W-9 will mail your information returns.

Line 6

Enter your city, state, and ZIP code.

Part I. Taxpayer Identification Number (TIN)

Enter your TIN in the appropriate box. If you are a resident alien and you do not have and are not eligible to get an SSN, your TIN is your IRS individual taxpayer identification number (ITIN). Enter it in the social security number box. If you do not have an ITIN, see *How to get a TIN* below.

If you are a sole proprietor and you have an EIN, you may enter either your SSN or EIN. However, the IRS prefers that you use your SSN.

If you are a single-member LLC that is disregarded as an entity separate from its owner (see *Limited Liability Company (LLC)* on this page), enter the owner's SSN (or EIN, if the owner has one). Do not enter the disregarded entity's EIN. If the LLC is classified as a corporation or partnership, enter the entity's EIN.

Note. See the chart on page 4 for further clarification of name and TIN combinations.

How to get a TIN. If you do not have a TIN, apply for one immediately. To apply for an SSN, get Form SS-5, Application for a Social Security Card, from your local SSA office or get this form online at www.ssa.gov. You may also get this form by calling 1-800-772-1213. Use Form W-7, Application for IRS Individual Taxpayer Identification Number, to apply for an ITIN, or Form SS-4, Application for Employer Identification Number, to apply for an EIN. You can apply for an EIN online by accessing the IRS website at www.irs.gov/businesses and clicking on Employer Identification Number (EIN) under Starting a Business. You can get Forms W-7 and SS-4 from the IRS by visiting IRS.gov or by calling 1-800-TAX-FORM (1-800-829-3676).

If you are asked to complete Form W-9 but do not have a TIN, apply for a TIN and write "Applied For" in the space for the TIN, sign and date the form, and give it to the requester. For interest and dividend payments, and certain payments made with respect to readily tradable instruments, generally you will have 60 days to get a TIN and give it to the requester before you are subject to backup withholding on payments. The 60-day rule does not apply to other types of payments. You will be subject to backup withholding on all such payments until you provide your TIN to the requester.

Note. Entering "Applied For" means that you have already applied for a TIN or that you intend to apply for one soon.

Caution: A disregarded U.S. entity that has a foreign owner must use the appropriate Form W-8.

Part II. Certification

To establish to the withholding agent that you are a U.S. person, or resident alien, sign Form W-9. You may be requested to sign by the withholding agent even if items 1, 4, or 5 below indicate otherwise.

For a joint account, only the person whose TIN is shown in Part I should sign (when required). In the case of a disregarded entity, the person identified on line 1 must sign. Exempt payees, see *Exempt payee code* earlier.

Signature requirements. Complete the certification as indicated in items 1 through 5 below.

- 1. Interest, dividend, and barter exchange accounts opened before 1984 and broker accounts considered active during 1983.** You must give your correct TIN, but you do not have to sign the certification.
- 2. Interest, dividend, broker, and barter exchange accounts opened after 1983 and broker accounts considered inactive during 1983.** You must sign the certification or backup withholding will apply. If you are subject to backup withholding and you are merely providing your correct TIN to the requester, you must cross out item 2 in the certification before signing the form.
- 3. Real estate transactions.** You must sign the certification. You may cross out item 2 of the certification.
- 4. Other payments.** You must give your correct TIN, but you do not have to sign the certification unless you have been notified that you have previously given an incorrect TIN. "Other payments" include payments made in the course of the requester's trade or business for rents, royalties, goods (other than bills for merchandise), medical and health care services (including payments to corporations), payments to a nonemployee for services, payments made in settlement of payment card and third party network transactions, payments to certain fishing boat crew members and fishermen, and gross proceeds paid to attorneys (including payments to corporations).
- 5. Mortgage interest paid by you, acquisition or abandonment of secured property, cancellation of debt, qualified tuition program payments (under section 529), IRA, Coverdell ESA, Archer MSA or HSA contributions or distributions, and pension distributions.** You must give your correct TIN, but you do not have to sign the certification.

What Name and Number To Give the Requester

For this type of account:	Give name and SSN of:
1. Individual	The individual
2. Two or more individuals (joint account)	The actual owner of the account or, if combined funds, the first individual on the account ¹
3. Custodian account of a minor (Uniform Gift to Minors Act)	The minor ²
4. a. The usual revocable savings trust (grantor is also trustee) b. So-called trust account that is not a legal or valid trust under state law	The grantor-trustee ¹ The actual owner ¹
5. Sole proprietorship or disregarded entity owned by an individual	The owner ³
6. Grantor trust filing under Optional Form 1099 Filing Method 1 (see Regulations section 1.671-4(b)(2)(i)(A))	The grantor*
For this type of account:	Give name and EIN of:
7. Disregarded entity not owned by an individual	The owner
8. A valid trust, estate, or pension trust	Legal entity ⁴
9. Corporation or LLC electing corporate status on Form 8832 or Form 2553	The corporation
10. Association, club, religious, charitable, educational, or other tax-exempt organization	The organization
11. Partnership or multi-member LLC	The partnership
12. A broker or registered nominee	The broker or nominee
13. Account with the Department of Agriculture in the name of a public entity (such as a state or local government, school district, or prison) that receives agricultural program payments	The public entity
14. Grantor trust filing under the Form 1041 Filing Method or the Optional Form 1099 Filing Method 2 (see Regulations section 1.671-4(b)(2)(i)(B))	The trust

¹ List first and circle the name of the person whose number you furnish. If only one person on a joint account has an SSN, that person's number must be furnished.

² Circle the minor's name and furnish the minor's SSN.

³ You must show your individual name and you may also enter your business or DBA name on the "Business name/disregarded entity" name line. You may use either your SSN or EIN (if you have one), but the IRS encourages you to use your SSN.

⁴ List first and circle the name of the trust, estate, or pension trust. (Do not furnish the TIN of the personal representative or trustee unless the legal entity itself is not designated in the account title.) Also see *Special rules for partnerships* on page 2.

*Note. Grantor also must provide a Form W-9 to trustee of trust.

Note. If no name is circled when more than one name is listed, the number will be considered to be that of the first name listed.

Secure Your Tax Records from Identity Theft

Identity theft occurs when someone uses your personal information such as your name, SSN, or other identifying information, without your permission, to commit fraud or other crimes. An identity thief may use your SSN to get a job or may file a tax return using your SSN to receive a refund.

To reduce your risk:

- Protect your SSN,
- Ensure your employer is protecting your SSN, and
- Be careful when choosing a tax preparer.

If your tax records are affected by identity theft and you receive a notice from the IRS, respond right away to the name and phone number printed on the IRS notice or letter.

If your tax records are not currently affected by identity theft but you think you are at risk due to a lost or stolen purse or wallet, questionable credit card activity or credit report, contact the IRS Identity Theft Hotline at 1-800-908-4490 or submit Form 14039.

For more information, see Publication 4535, Identity Theft Prevention and Victim Assistance.

Victims of identity theft who are experiencing economic harm or a system problem, or are seeking help in resolving tax problems that have not been resolved through normal channels, may be eligible for Taxpayer Advocate Service (TAS) assistance. You can reach TAS by calling the TAS toll-free case intake line at 1-877-777-4778 or TTY/TDD 1-800-829-4059.

Protect yourself from suspicious emails or phishing schemes. Phishing is the creation and use of email and websites designed to mimic legitimate business emails and websites. The most common act is sending an email to a user falsely claiming to be an established legitimate enterprise in an attempt to scam the user into surrendering private information that will be used for identity theft.

The IRS does not initiate contacts with taxpayers via emails. Also, the IRS does not request personal detailed information through email or ask taxpayers for the PIN numbers, passwords, or similar secret access information for their credit card, bank, or other financial accounts.

If you receive an unsolicited email claiming to be from the IRS, forward this message to phishing@irs.gov. You may also report misuse of the IRS name, logo, or other IRS property to the Treasury Inspector General for Tax Administration (TIGTA) at 1-800-366-4484. You can forward suspicious emails to the Federal Trade Commission at: spam@uce.gov or contact them at www.ftc.gov/idtheft or 1-877-IDTHEFT (1-877-438-4338).

Visit IRS.gov to learn more about identity theft and how to reduce your risk.

Privacy Act Notice

Section 6109 of the Internal Revenue Code requires you to provide your correct TIN to persons (including federal agencies) who are required to file information returns with the IRS to report interest, dividends, or certain other income paid to you; mortgage interest you paid; the acquisition or abandonment of secured property; the cancellation of debt; or contributions you made to an IRA, Archer MSA, or HSA. The person collecting this form uses the information on the form to file information returns with the IRS, reporting the above information. Routine uses of this information include giving it to the Department of Justice for civil and criminal litigation and to cities, states, the District of Columbia, and U.S. commonwealths and possessions for use in administering their laws. The information also may be disclosed to other countries under a treaty, to federal and state agencies to enforce civil and criminal laws, or to federal law enforcement and intelligence agencies to combat terrorism. You must provide your TIN whether or not you are required to file a tax return. Under section 3406, payers must generally withhold a percentage of taxable interest, dividend, and certain other payments to a payee who does not give a TIN to the payer. Certain penalties may also apply for providing false or fraudulent information.

INDEX TO
PROPOSAL

DESCRIPTION

Vendor Responsibility Questionnaire	4 pages
Certificate of Authority	1 page
Certification of Experience	1 page
Bid Security Form	1 page
Bidder's Checklist	1 page
Proposal	2 pages
Certification of Compliance With Iran Divestment Act	1 page
Non-Collusive Bidding Certification	1 page
Contractor's Acknowledgement	1 page

**ESSEX COUNTY
VENDOR RESPONSIBILITY QUESTIONNAIRE**

1. VENDOR IS: ____PRIME CONTRACTOR			
2. VENDOR'S LEGAL BUSINESS NAME		3. IDENTIFICATION NUMBERS A) FEIN # B) DUNS #	
4. D/B/A – Doing Business As (if applicable) & COUNTY FIELD		5. WEBSITE ADDRESS (if applicable)	
6. ADDRESS OF PRIMARY PLACE OF BUSINESS/EXECUTIVE OFFICE		7. TELEPHONE NUMBER	8. FAX NUMBER
9. ADDRESS OF PRIMARY PLACE OF BUSINESS/EXECUTIVE OFFICE <i>IN NEW YORK STATE, if different from above</i>		10. TELEPHONE NUMBER	11. FAX NUMBER
12. AUTHORIZED CONTACT FOR THIS QUESTIONNAIRE Name Title Telephone Number Fax Number Email			
13. LIST ALL OF THE VENDOR'S PRINCIPAL OWNERS			
A) NAME	TITLE	B) NAME	TITLE
C) NAME	TITLE	D) NAME	TITLE
A DETAILED EXPLANATION IS REQUIRED FOR EACH QUESTION ANSWERED WITH A "YES," AND MUST BE PROVIDED AS AN ATTACHMENT TO THE COMPLETED QUESTIONNAIRE. YOU MUST PROVIDE ADEQUATE DETAILS OR DOCUMENTS TO AID THE COUNTY IN MAKE A DETERMINATION OF VENDOR RESPONSIBILITY. PLEASE NUMBER EACH RESPONSE TO MATCH THE QUESTION NUMBER.			
14. DOES THE VENDOR USE, OR HAS IT USED IN THE PAST FIVE (5) YEARS, ANY OTHER BUSINESS NAME, FEIN, or D/B/A OTHER THAN THOSE LISTED IN ITEMS 2-4 ABOVE? List all other business name(s), Federal Employer Identification Number(s) or any D/B/A names and the dates that these names or numbers were/are in use. Explain the relationship to the vendor ___ YES ___ NO			
15. ARE THERE ANY INDIVIDUALS NOW SERVING IN A MANAGERIAL OR CONSULTING CAPACITY TO THE VENDOR, INCLUDING PRINCIPAL OWNERS AND OFFICERS, WHO NOW SERVE OR IN THE PAST ONE (1) YEARS HAVE SERVED AS:			
a) An elected or appointed public official or officer? <i>List each individual's name, business title, the name of the organization and position elected or appointed to, and dates of service</i>			___ YES ___ NO
b) An officer of any political party organization in Essex County, whether paid or unpaid? <i>List each individuals name, business title or consulting capacity and the official political position held with applicable service dates.</i>			___ YES ___ NO

16. WITHIN THE PAST (5) YEARS, HAS THE VENDOR, ANY INDIVIDUALS SERVING IN MANAGERIAL OR CONSULTING CAPACITY, PRINCIPAL, OWNERS, OFFICERS, MAJOR STOCKHOLDER(S) (10% OR MORE OF THE VOTING SHARES FOR PUBLICLY TRADED COMPANIES, 25% OR MORE OF THE SHARES FOR ALL OTHER COMPANIES), AFFILIATE OR ANY PERSON INVOLVED IN THE BIDDING OR CONTRACTING PROCESS:

- a) 1. been suspended, debarred or terminated by a local, state or federal authority in connection with a contract or contracting process; ___ YES ___ NO
- 2. been disqualified for cause as a bidder on any permit, license, concession, franchise or lease;
- 3. entered into an agreement to a voluntary exclusion from bidding/contracting;
- 4. had a bid rejected on an Essex County contract for failure to comply with the MacBride Fair Employment Principles;
- 5. had a low bid rejected on a local, state or federal contract for failure to meet statutory affirmative action or M/WBE requirements on a previously held contract;
- 6. had a status as a Women's Business Enterprise, Minority Business Enterprise or Disadvantaged Business Enterprise, de-certified, revoked or forfeited;
- 7. been subject to an administrative proceeding or civil action seeking specific performance or restitution in connection with any local, state or federal government contract;
- 8. been denied an award of a local, state or federal government contract, had a contract suspended or had a contract terminated for non-responsibility; or
- 9. had a local, state or federal government contract suspended or terminated for cause prior to the completion of the term of the contract.
- b) been indicted, convicted, received a judgment against them or a grant of immunity for any business-related conduct constituting a crime under local, state or federal law including but not limited to, fraud, extortion, bribery, racketeering, price-fixing, bid collusion or any crime related to truthfulness and/or business conduct? ___ YES ___ NO
- c) been issued a citation, notice, violation order, or are pending an administrative hearing or proceeding or determination of violations of: ___ YES ___ NO
 - 1. federal, state or local health laws, rules or regulations

17. IN THE PAST THREE (3) YEARS, HAS THE VENDOR OR ITS AFFILIATES' HAD ANY CLAIMS, JUDGMENTS, INJUNCTIONS, LIENS, FINES OR PENALTIES SECURED BY ANY GOVERNMENTAL AGENCY? Indicate if this is applicable to the submitting vendor or affiliate. State whether the situation(s) was a claim, judgment, injunction, lien or other with an explanation. Provide the name(s) and address(es) of the agency, the amount of the original obligation and outstanding balance. If any of these items are open, unsatisfied, indicate the status of each items as "open" or "unsatisfied". ___ YES ___ NO

18. DURING THE PAST THREE (3) YEARS, HAS THE VENDOR FAILED TO:

- a) file returns or pay any applicable federal, state or city taxes?
Identify the taxing jurisdiction, type of tax, liability year(s), and tax liability amount the vendor failed to file/pay and the current status of the liability. ___ YES ___ NO
- b) file returns or pay New York State unemployment insurance?
Indicate the years the vendor failed to file/pay the insurance and the current status of the liability. ___ YES ___ NO
- c) Property Tax
Indicate the years the vendor failed to file. ___ YES ___ NO

19. HAVE ANY BANKRUPTCY PROCEEDINGS BEEN INITIATED BY OR AGAINST THE VENDOR OR ITS AFFILIATES' WITHIN THE PAST SEVEN (7) YEARS (WHETHER OR NOT CLOSED) OR IS ANY BANKRUPTCY PROCEEDING PENDING BY OR AGAINST THE VENDOR OR ITS AFFILIATES REGARDLESS OF THE DATE OF FILING? ___ YES ___ NO

Indicate if this is applicable to the submitting vendor or affiliate. If it is an affiliate, include the affiliate's name and FEIN. Provide the court name, address and docket number. Indicate if the proceedings have been initiated, remain pending or have been closed. If closed, provide the date closed.

20. IS THE VENDOR CURRENTLY INSOLVENT, OR DOES VENDOR CURRENTLY HAVE REASON TO BELIEVE THAT AN INVOLUNTARY BANKRUPTCY PROCEEDING MAY BE BROUGHT AGAINST IT? Provide financial information to support the vendor's current position, for example, Current Ration, Debt Ration, Age of Accounts Payable, Cash Flow and any documents that will provide the agency with an understanding of the vendor's situation. YES NO

21. IN THE PAST FIVE (5) YEARS, HAS THE VENDOR OR ANY AFFILIATES:
a) defaulted or been terminated on, or had its surety called upon to complete, any contract (public or private) awarded; YES NO
Indicate if this is applicable to the submitting vendor or affiliate. Detail the situation(s) that gave rise to the negative action, any corrective action taken by the vendor and the name of the contracting agency.

¹ "Affiliate" meaning: (a) any entity in which the vendor owns more than 50% of the voting stock; (b) any individual, entity or group of principal owners or officers who own more than 50% of the voting stock of the vendor; or (c) any entity whose voting stock is more than 50% owned by the same individual, entity or group described in clause (b). In addition, if a vendor owns less than 50% of the voting stock of another entity, but directs or has the right to direct such entity's daily operations, that entity will be an "affiliate" for purposes of

this questionnaire.

**ESSEX COUNTY
VENDOR RESPONSIBILITY QUESTIONNAIRE**

FEIN # _____

State of:)
) ss:
County of:)

CERTIFICATION:

The undersigned: recognizes that this questionnaire is submitted for the express purpose of assisting the County of Essex in making a determination regarding an award of contract or approval of a subcontract; acknowledges that the County may in its discretion, by means which it may choose, verify the truth and accuracy of all statements made herein; acknowledges that intentional submission of false or misleading information may constitute a felony under Penal Law Section 210.40 or a misdemeanor under Penal Law Section 210.35 or Section 210.45, and may also be punishable by a fine and/or imprisonment of up to five years under 18 USC Section 1001 and may result in contract termination; and states that the information submitted in this questionnaire and any attached pages is true, accurate and complete.

The undersigned certifies that he/she:

- Has not altered the content of the questions in the questionnaire in any manner;
- Has read and understands all of the items contained in the questionnaire and any pages attached by the submitting vendor;
- Has supplied full and complete responses to each item therein to the best of his/her knowledge, information and belief;
- Is knowledgeable about the submitting vendor’s business and operations;
- Understands that Essex County will rely on the information supplied in the questionnaire when entering into a contract with the vendor;
- Is under duty to notify the Essex County Purchasing Officer of any changes to the vendor’s responses.

Name of Business: _____

Signature of Owner: _____

Printed Name of Signatory: _____

Title: _____

Address: _____ City, State, Zip: _____

Date: _____

Sworn before me this ____ day of
_____, 20__

Notary Public

CERTIFICATE OF AUTHORITY

I, _____
(Officer other than officer executing proposal documents)

certify that I am the _____ of the _____
(Title) (Name of Contractor)

_____ a corporation, duly organized and in good standing under the

(Law under which organized, e.g., the New York Business Corporation Law)

named in the foregoing agreement; that _____
(Person executing proposal documents)

who signed said agreement on behalf of the Contractor was, at the time of execution,
_____ of the Contractor; that said agreement was duly signed for
(Title of such person)

and in behalf of said Contractor by authority of its Board of Directors, thereunto duly authorized, and that
such authority is in full force and effect at the date hereof.

Signature Corporate Seal

STATE OF NEW YORK) SS.:
COUNTY OF ESSEX)

On this _____ day of _____, 20____, before me personally came _____
_____ to me known, and known to me to be the _____

(Title) of _____ the corporation described in
and which executed the above certificate, who being by me duly sworn did depose and say that he, the said _____
_____ resides at _____, and that he is _____
_____ of said corporation and knows the corporate seal of the said corporation; that the
seal affixed to the above certificate is such corporate seal and that it was so affixed by order of the Board of
Directors of said corporation, and that he signed his name thereto by like order.

Notary Public County

CERTIFICATION OF EXPERIENCE

BIDDER: _____

I, _____ HEREBY CERTIFY THAT (COMPANY _____
_____ HAS PERFORMED THE FOLLOWING WORK WITHING THE LAST
THREE YEARS **UNLESS SPECIFIED DIFFERENTLY IN THE SPECIFICATION:**

NAMES OF BUSINESS: _____ CONTACT NAME: _____

ADDRESS: _____

AMOUNT OF CONTRACT: _____ TELEPHONE NO.: _____

TYPE OF WORK: _____ FAX NO.: _____

NAMES OF BUSINESS: _____ CONTACT NAME: _____

ADDRESS: _____

AMOUNT OF CONTRACT: _____ TELEPHONE NO.: _____

TYPE OF WORK: _____ FAX NO.: _____

NAMES OF BUSINESS: _____ CONTACT NAME: _____

ADDRESS: _____

AMOUNT OF CONTRACT: _____ TELEPHONE NO.: _____

TYPE OF WORK: _____ FAX NO.: _____

NAMES OF BUSINESS: _____ CONTACT NAME: _____

ADDRESS: _____

AMOUNT OF CONTRACT: _____ TELEPHONE NO.: _____

TYPE OF WORK: _____ FAX NO.: _____

NAMES OF BUSINESS: _____ CONTACT NAME: _____

ADDRESS: _____

AMOUNT OF CONTRACT: _____ TELEPHONE NO.: _____

TYPE OF WORK: _____ FAX NO.: _____

NAMES OF BUSINESS: _____ CONTACT NAME: _____

ADDRESS: _____

AMOUNT OF CONTRACT: _____ TELEPHONE NO.: _____

TYPE OF WORK: _____ FAX NO.: _____

BID SECURITY

(ATTACHED HERE – CERTIFIED CHECK, CASH OR BID BOND)

BIDDER'S CHECKLIST

Each of the following forms must be executed and notarized if applicable:

VENDOR RESPONSIBILITY QUESTIONNAIRE _____ [HAVE NOTARIZED]

CERTIFICATE OF AUTHORITY _____

CERTIFICATION OF EXPERIENCE _____

BID SECURITY _____

PROPOSAL _____

CERTIFICATION OF COMPLIANCE
WITH IRAN DIVESTMENT ACT _____ [HAVE NOTARIZED]

NON-COLLUSIVE BIDDING CERTIFICATION _____ [HAVE NOTARIZED]

PROPOSAL

Date: _____

Proposal of _____

to furnish and deliver all labor, supervision, materials, and equipment and perform all work in accordance with the Specifications for Exterior Stair Replacement the Town of Elizabethtown, New York for the following lump sum cost.

The owner, Essex County, is tax-exempt. Do not include sales tax in Bid amounts.

The undersigned bidder has carefully examined the contract documents, site of the work, is familiar with existing conditions, and will provide all necessary insurance, bonds, machinery, tools, apparatus, false work and other means of construction, and do all the work and furnish all the materials called for by said contract according to the following bid, including all labor, supplies and equipment, permits, fees, overhead and profit for the following Lump Sum price. The Lump Sum price is to be shown in both words and figures. In the event of discrepancies, the amount shown in words shall govern. All items are to be furnished and installed in place complete.

(Amount in Words)

(Amount in Figures)

The undersigned further understands that the contract will be awarded to the competent, qualified bidder submitting the lowest bid for the Total Bid.

ADDENDA ACKNOWLEDGEMENT

<u>Addendum No.</u>	<u>Date Received</u>
_____	_____
_____	_____
_____	_____

The undersigned agrees as follows:

1. The total contract price bid shall be accepted as full compensation for the complete work subject to additions or deductions in quantity of work performed or changes agreed upon.
2. Within twenty (20) days from the date of "Notice of Acceptance" of the Proposal, to execute the contract and to furnish a satisfactory labor, material and performance bond in the amount of 100% of the contract price.
3. To execute the work as specified herein as soon as possible after notice of award.

4. To comply with requirements as to the conditions of employment, wage rates and hours set forth in the bidding documents.
5. Progress Payments will be made on a percentage of completion basis monthly.
6. 5% Retainage will be withheld until final approval of project(s).

Bidder: _____

By: _____

Title: _____

Address: _____

Dated: _____

Telephone: _____

Fax: _____

Social Security/Federal ID No: _____

Email: _____

CERTIFICATION OF COMPLIANCE WITH THE IRAN DIVESTMENT ACT

As a result of the Iran Divestment Act of 2012 (the "Act"), Chapter 1 of the 2012 Laws of New York, a new provision has been added to State Finance Law (SFL) § 165-a and New York General Municipal Law § 103-g, both effective April 12, 2012. Under the Act, the Commissioner of the Office of General Services (OGS) will be developing a list of "persons" who are engaged in "investment activities in Iran" (both are defined terms in the law) (the "Prohibited Entities List"). Pursuant to SFL § 165-a(3)(b), the initial list is expected to be issued no later than 120 days after the Act's effective date at which time it will be posted on the OGS website.

By submitting a bid in response to this solicitation or by assuming the responsibility of a Contract awarded hereunder, each Bidder/Contractor, any person signing on behalf of any Bidder/Contractor and any assignee or subcontractor and, in the case of a joint bid, each party thereto, certifies, under penalty of perjury, that once the Prohibited Entities List is posted on the OGS website, that to the best of its knowledge and belief, that each Bidder/Contractor and any subcontractor or assignee is not identified on the Prohibited Entities List created pursuant to SFL § 165-a(3)(b).

Additionally, Bidder/Contractor is advised that once the Prohibited Entities List is posted on the OGS Website, any Bidder/Contractor seeking to renew or extend a Contract or assume the responsibility of a Contract awarded in response to this solicitation must certify at the time the Contract is renewed, extended or assigned that it is not included on the Prohibited Entities List.

During the term of the Contract, should the County receive information that a Bidder/Contractor is in violation of the above-referenced certification, the County will offer the person or entity an opportunity to respond. If the person or entity fails to demonstrate that he/she/it has ceased engagement in the investment which is in violation of the Act within 90 days after the determination of such violation, then the County shall take such action as may be appropriate including, but not limited to, imposing sanctions, seeking compliance, recovering damages or declaring the Bidder/Contractor in default.

The County reserves the right to reject any bid or request for assignment for a Bidder/Contractor that appears on the Prohibited Entities List prior to the award of a contract and to pursue a responsibility review with respect to any Bidder/Contractor that is awarded a contract and subsequently appears on the Prohibited Entities List.

I, _____, being duly sworn, deposes and says that he/she is the _____ of the _____ Corporation and that neither the Bidder/Contractor nor any proposed subcontractor is identified on the Prohibited Entities List.

SIGNED

SWORN to before me this _____
day of _____, 20__

Notary Public

NON-COLLUSIVE BIDDING CERTIFICATION

1. By submission of this bid, the undersigned bidder and each person signing on behalf of such bidder certifies and in the case of a joint bid each party thereto certifies as to its own organization — UNDER PENALTY OF PERJURY, that to the best of the undersigned’s knowledge and belief:

- (a) The prices in this bid have been arrived at independently without collusion, consultation, communication, or agreement, for the purpose of restricting competition, as to any matter relating to such prices with any other bidder or with any competitor;
- (b) Unless otherwise required by law, the prices which have been quoted in this bid have not been knowingly disclosed by the bidder and will not knowingly be disclosed by the bidder prior to opening, directly or indirectly, to any other bidder or to any competitor; and
- (c) No attempt has been made or will be made by the bidder to induce any other person, partnership or corporation to submit or not to submit a bid for the purpose of restricting competition.

2. The undersigned acknowledges and agrees that a bid shall not be considered for award nor shall any award be made where any of the above have not been complied with; provided however, that if in any case the bidder cannot make the foregoing certification, the bidder shall so state and shall furnish with the bid a signed statement which sets forth in detail the reasons therefor. Where one or more of the above has/have not been complied with, the bid shall not be considered for award nor shall any award be made unless the political subdivision, public department, agency or official thereof to which the bid is made, or his designee, determines that such disclosure was not made for the purpose of restricting competition.

3. The undersigned also acknowledges and agrees that the fact that a bidder (a) has published price lists, rates, or tariffs covering items being procured, (b) has informed prospective customers of proposed or pending publication of new or revised price lists for such items, or (c) has sold the same items to other customers at the same prices being bid, does not constitute, without more, a disclosure within the meaning of paragraph 1 above.

4. The undersigned further acknowledges and agrees that any bid hereafter made to any political subdivision of the state or any public department, agency or official thereof by a bidder which is a corporation or a limited liability company for work or services performed or to be performed or goods sold or to be sold, where competitive bidding is required by statute, rule, regulation, or local law, and where such bid contains the certification referred to in paragraph 1 of this certificate, shall be deemed to have been authorized by the board of directors of the bidder, and such authorization shall be deemed to include the signing and submission of the bid and the inclusion therein of the certificate as to non-collusion as the act and deed of the corporation or limited liability company.

Name of Bidder: _____
(print full legal name)

Date Signed: _____ Signature: _____

Name of Person Signing Certificate: _____
(print full legal name of signer)

Bidder is (check one): an individual, a limited liability partnership, a limited liability company,
 other entity (specify): _____

CONTRACTOR'S ACKNOWLEDGEMENT

(If Corporation)

STATE OF NEW YORK) SS:
COUNTY OF ESSEX)

On this _____ day of _____ 20____, before me personally came _____
_____ to me known, and known to me to be the _____
of the Corporation described in and which executed the within instrument, who being duly sworn did depose
and say that he, the said _____ reside at _____ and
that he is _____ of said corporation and knows the corporate seal of the said
corporation; that the seal affixed to the within instrument is such corporate seal and that it was so affixed by
order of the Board of Directors of said corporation, and that he signed his name thereto by like order.

Notary Public

CONTRACTOR'S ACKNOWLEDGEMENT

(If Individual)

STATE OF NEW YORK) SS:
COUNTY OF ESSEX)

On this _____ day of _____ 20____, before me personally came
_____ to me known, and known to me to be the same
person described in and who executed the within instrument and he duly acknowledged to me that he executed
the same for the purpose herein mentioned and, if operating under and trade name, that the certificate required
by the New York State Penal Law, Sections 440 and 440-b has been filed with the County Clerk of Essex
County.

Notary Public

CONTRACTOR'S ACKNOWLEDGEMENT

(If Co-Partnership)

STATE OF NEW YORK) SS:
COUNTY OF ESSEX)

On this _____ day of _____ 20____, before me personally came
_____ to me known, and known to me to be a member of the firm of and
the person described in, and who executed the within instrument in behalf of said firm for the purposes herein
mentioned and that the certificate required by the New York State Penal Law, Sections 440 and 440-b has been
filed with the County Clerk of Essex County.

Notary Public